

**Virginia Board for Contractors Committee
Department of Professional & Occupational Regulation
9960 Mayland Drive, Board Room 2
Richmond, Virginia, 23233
October 20, 2014.**

TENTATIVE AGENDA

1. **Call to Order**
2. **Approval of Agenda**
3. **Approval of Minutes from the August 25, 2014 meeting**
4. **Public Comment Period**
5. **Education Provider Applicants**
 - A. **Ace Tech Institute – Electrical, Plumbing, HVAC/Mechanical, Gas Fitter**
 - B. **RedVector.com LLC – Electrical Continuing Education Online**
6. **Old Business**
7. **New Business**
 - A. Application Integrity
 - B. Exam Site Change – Elimination of Walk-Ins
 - C. Review of Board Policies
 - D. Remedial Education Report
 - E. Continuing Education Workgroup Update
 - F. Regulatory Review
 - G. Legislative Review
8. **Adjourn**

**BOARD FOR CONTRACTORS COMMITTEE
MEETING **DRAFT** MINUTES**

The Board for Contractors Committee (“the Committee”) met on **Monday, August 25th, 2014**, at the Department of Professional and Occupational Regulation (DPOR), 9960 Mayland Drive, Richmond, Virginia. The following Committee members were present:

Herbert J. Dyer, Jr., Chairman
Bailey Dowdy
E. G. Middleton, III
Doug Murrow
D. Todd Vander Pol

The following DPOR staff members were present for all or part of the meeting:

Mindy Spruill, Regulatory Boards Administrator
Karen Bullock, Administrative Assistant, Compliance Specialist
Adrienne Mayo, Regulatory Boards Administrator
Sheila Watkins, Administrative Assistant, Compliance Specialist
Paul Saunders, Education Specialist

During the month of July Mr. Chancey Walker resigned as a member of the Committee.

Chairman Dyer called the meeting to order at 2:01 P.M.

Call To Order

The Meeting Agenda was approved unanimously. Motion made by **Mr. Vander Pol**, seconded by **Mr. Middleton**. Motion approved by unanimous vote. Members voting “yes” were: Dyer, Vander Pol, Dowdy, Middleton, and Murrow.

Approval of Agenda

The Minutes from the June 23rd, 2014 Committee meeting were adopted as drafted by unanimous vote. Motion made by **Mr. Dowdy**, seconded by **Mr. Vander Pol**. Motion approved by unanimous vote. Members voting “yes” were: Dyer, Vander Pol, Dowdy, Middleton and Murrow.

Minutes Adopted

There was no public comment.

Public Comment

Items requiring Board action are marked with an asterisk (*): Adrienne Mayo Regulatory Board Administrator and Paul Saunders Education Specialist addressed the Board.

Education Provider Applications

Education Provider Applications*

Applications for proposed education providers and courses were reviewed and the Committee’s recommendations are as follows:

Mr. Saunders shared that staff recommends approval for **KEB America, Inc.** – Certified Elevator Mechanic Continuing Education classroom course. After discussion, and a motion by **Mr. Vander Pol**, seconded by **Mr. Murrow**, the Committee unanimously recommended the Board approve KEB America, Inc. – Certified Elevator Mechanic Continuing Education Provider. Motion approved by unanimous vote. Members voting “yes” were: Dyer, Vander Pol, Dowdy, Middleton and Murrow.

KEB America Inc. – Certified Elevator Mechanic

Mr. Saunders shared that staff recommends approval for **National Drilling Association- Electrical** Continuing Education classroom course.

After discussion and a motion by **Mr. Vander Pol**, seconded by **Mr. Murrow**, the Committee unanimously recommended the Board approve of National Fire Protection Association Electrical Continuing Education Classroom course. Motion approved by unanimous vote. Members voting "yes" were: Dyer, Vander Pol, Dowdy, Middleton and Murrow.

There was no old business.

Exam/Education Switch

Board Administrator, Adrienne Mayo provided the Committee with an update on the effective date of the new code. It is July 14, 2014. She shared that letters were mailed to the education providers alerting them that effective November 1, 2014 the Board requires the new code updates be included in their curriculum.

Examination Contract

Ms. Spruill, Board Administrator shared that we are now in our 2nd one year extension. Staff is starting the Request for Proposal for new examination review. We have until July 1, 2015 for completion.

SDS/OSSP Letter and QI requirements

Board Administrator, Mindy Spruill told the Committee that a letter was sent out on August 1, 2014 alerting current license holders with the SDS/OSSP specialty that they have until November 1, 2014 to come into compliance or the specialty will be removed from their license. She indicated that many have contacted the Board staff and shared they no longer need the specialty and have asked to have it removed from the license.

Remedial Education Classes

Ms. Spruill shared with the Committee that the last Remedial Education class went well. So far the Class size ranges from 5 to 20. We have

National Fire Protection Association – Electrical Continuing Education Classroom

Old Business

New Business

Promulgation of 2012 USBC – Exam/Education Switch

Examination Contract – RFP Update

SDS/OSSP Letter and QI Requirements

Remedial Education Report

updated the class schedule and it and the Registration form are available on the Board's website.

Workgroup Update

Ms. Spruill shared that the Continuing Education Workgroup covered a lot of ground today (August 25). She reviewed the ideas with the Committee for consideration.

The Committee had the following recommendations.

Online offerings:

- Keep online options and enhance the security measures.
- Consider requiring Provider fees and Course fees.
- Initial application fees and renewal fees.
- Separate course fees with expiration 6 months after Virginia's code change.
- Consideration of non code update courses expiration date.

Course Expiration Dates:

- Staff to review, critique other areas i.e. Real Estate, CNG, and provide feedback and additional options for consideration to the workgroup and the Committee at the October meeting.
- Test creation and Cost assessment.
- Pay if you fail assessment test.
- Expanding code options.

Knowledge Assessment:

- Provide the option of pre testing.
- Perhaps proctor the exam.
- Economic burden to the licensee.
- Consideration of Regulatory requirements.
- The workgroup wants staff to gather additional information on how other states complete this process; specifically Colorado. Workgroup wants staff to review monitoring, fees, online options and costs involved.

Expanded Course Offerings:

- Confer with Board counsel for change requirements
- Management of primary and supplemental courses.
- Review management of partial course completion, i.e. Real Estate.

Continuing Education Workgroup Update

- Expansion of course offerings.
- Primary and supplemental course changes.
- Electable in addition to code update I code hasn't updated w/in the renewal cycle.

Licensing the provider/courses/instructors

- Recommendations were included in course expiration dates area.

Additional Discussion:

- Requiring Tradesman on the job site – would like to look into this as a regulatory change option.

John Tyler Community College Request

Dr. Julie Ransom and Alan Massengill spoke with the Committee members and reviewed their handout with them. The handout shared information that was compiled for the course curriculum being presented for consideration. Alan Massengill shared that John Tyler CC wants to offer a certification and an Associate Degree Program for Electrical that will be acceptable to the Board for Contractors as appropriate and beneficial to the students as they apply for licensure. The committee members discussed the proposed curriculum in detail. After additional discussion, it was determined that Board administrator Adrienne Mayo will provide an electronic application packet to Mr. Massengill for personal use. The Committee shared that John Tyler meets the criteria as a state approved school. Mr. Middleton and the Committee thanked Dr. Ransom and Mr. Massengill for coming in and for sharing information and answering questions about the proposed classes.

John Tyler Community College Request

Regulatory Review

Currently we have a total of 6 packets in the Governor's office. We still have three Regulations in the proposed stage, and three in the final stage in the Governor's office. The NOIRA for the amendments of specialties are in development and are being reviewed today and hope to have proposed regulations adopted by the Board at the October meeting.

The Committee was given a handout for review and encouraged to share comments on Amendments to classifications and specialties. This prep work will assist staff in preparing the new regulation packet for Contractor license specialties.

Regulatory Review

The Committee suggests adding the following specialties:

Drywall Contracting, Finish Carpentry, Flooring and Floor Covering Contracting, Glass and Glazing Contracting, Insulation and Weather Stripping Contracting, Fire Proofing and Fire Caulking, Steel Erection Contracting, Tile Marble Ceramic and Terrazzo Contracting, and Underground utility and excavating contracting.

The Committee discussed adding these specialties and recommends not to pursue further: following specialties:
Caulking and Welding

The Committee decided they will submit the recommendations to the Board concerning the specialties.

Legislative Review

Nothing at this time.

Legislative Review

The next Committee Meeting will be held on Monday, **October 20, 2014.**

Next Meeting

Mr. Dowdy offered a motion seconded by **Mr. Dyer**, the Committee unanimously voted to adjourn the meeting at 2:38 p.m.

Adjourn

Herbert J. Dyer, Jr., Chairman

Date

APPLICATION REVIEW SUMMARY

October 21, 2014

PROVIDER NAME:	Ace Tech Institute (Millennium)												
TYPE OF COURSE:	Continuing Education												
SUBJECT(S):	Electrical, Plumbing, HVAC/Mechanical, Gas Fitter												
METHOD OF INSTRUCTION:	Online												
PREVIOUS BOARD APPROVAL(S):	2730000056												
STAFF RECOMMENDATION:	APPROVAL OF THE FOLLOWING COURSE(S) <table><thead><tr><th>COURSE NAME</th><th>HOURS</th></tr></thead><tbody><tr><td>Contractor Pre-license course</td><td>8.0</td></tr><tr><td>2012 Plumbing Update</td><td>3.0</td></tr><tr><td>2012 HVAC/Mechanical Update</td><td>3.0</td></tr><tr><td>2012 Electrical Update</td><td>3.0</td></tr><tr><td>2012 Gas Fitter Update</td><td>1.0</td></tr></tbody></table>	COURSE NAME	HOURS	Contractor Pre-license course	8.0	2012 Plumbing Update	3.0	2012 HVAC/Mechanical Update	3.0	2012 Electrical Update	3.0	2012 Gas Fitter Update	1.0
COURSE NAME	HOURS												
Contractor Pre-license course	8.0												
2012 Plumbing Update	3.0												
2012 HVAC/Mechanical Update	3.0												
2012 Electrical Update	3.0												
2012 Gas Fitter Update	1.0												

EDUCATION APPLICATION CHECKLIST

Staff Recommendation:	<input type="checkbox"/> Approve	<input type="checkbox"/> Non-approval
ED Provisional Approval	<input type="checkbox"/> Y	<input type="checkbox"/> N Date: _____
Committee Approval	<input type="checkbox"/> Y	<input type="checkbox"/> N Date: _____
Board Approval	<input type="checkbox"/> Y	<input type="checkbox"/> N Date: _____

Provider Name & # 2730000056 Ace Tech Institute (Millennium)
 Number (last 6 Digits): _____

Review Date: **October 6, 2014**

Initial Provider Approval Amendment to Existing Course Approval

Contact Name: **Wane Kim**

Contact Number: _____

Email: _____

Type of Course and Subject:

CE	Voc.		Online	Class	Other
		Tradesman & Individual Certification			
<input checked="" type="checkbox"/>	<input type="checkbox"/>	Plumbing	<input type="checkbox"/>	<input type="checkbox"/>	<input type="checkbox"/>
<input checked="" type="checkbox"/>	<input type="checkbox"/>	Electrical	<input checked="" type="checkbox"/>	<input type="checkbox"/>	<input type="checkbox"/>
<input checked="" type="checkbox"/>	<input type="checkbox"/>	HVAC	<input type="checkbox"/>	<input type="checkbox"/>	<input type="checkbox"/>
<input checked="" type="checkbox"/>	<input type="checkbox"/>	Gas Fitter	<input type="checkbox"/>	<input type="checkbox"/>	<input type="checkbox"/>
<input type="checkbox"/>	<input type="checkbox"/>	LP Gas Fitter	<input type="checkbox"/>	<input type="checkbox"/>	<input type="checkbox"/>
<input type="checkbox"/>	<input type="checkbox"/>	NG Fitter Provider	<input type="checkbox"/>	<input type="checkbox"/>	<input type="checkbox"/>
<input type="checkbox"/>	<input type="checkbox"/>	Certified Elevator Mechanic	<input type="checkbox"/>	<input type="checkbox"/>	<input type="checkbox"/>
<input type="checkbox"/>	<input type="checkbox"/>	Certified Water Well Providers	<input type="checkbox"/>	<input type="checkbox"/>	<input type="checkbox"/>
<input type="checkbox"/>	<input type="checkbox"/>	Certified Backflow Prevention Device Worker	<input type="checkbox"/>	<input type="checkbox"/>	<input type="checkbox"/>
<input checked="" type="checkbox"/>		Contractor Pre-License	<input type="checkbox"/>	<input type="checkbox"/>	<input type="checkbox"/>
		Contractor Remedial			
	<input type="checkbox"/>	Remedial Education – Basic	<input type="checkbox"/>	<input type="checkbox"/>	<input type="checkbox"/>
	<input type="checkbox"/>	Remedial Education – Advanced	<input type="checkbox"/>	<input type="checkbox"/>	<input type="checkbox"/>

Course Information

Course Name	Contact Hours	Credit Hours	Trades Only	
			Subject	Course Type
Contractor Pre-license course	8	8	Pre-License	Pre-License
2012 Plumbing Update	3	3	PLB	CE
2012 HVAC/Mecganical Update	3	3	HVAC	CE
2012 Electrical Update	3	3	ELE	CE
2012 Gas Fitter Update	1	1	GFC	CE

Documentation:

<input checked="" type="checkbox"/>	Course Syllabus
<input checked="" type="checkbox"/>	Outline of Courses
<input type="checkbox"/> Yes	Time Allocations per Topic Provided?

<input checked="" type="checkbox"/> No	
<input checked="" type="checkbox"/>	Fees Yes
<input checked="" type="checkbox"/>	Materials Listing Yes
<input checked="" type="checkbox"/> Yes <input type="checkbox"/> No	Handbook/Slides/Information Provided? Powerpoint Presentation
<input type="checkbox"/>	Schedule of Course Dates
<input type="checkbox"/>	Schedule of Locations

CONTRACTOR PRELICENSE/REMEDIAL

<input checked="" type="checkbox"/>	Board Regulations Covered
-------------------------------------	---------------------------

TRADESMAN CE

<input checked="" type="checkbox"/>	Code Updates Covered
-------------------------------------	----------------------

Comments:

Online Courses Only

- Demonstration/Web Access Provided
- Security Policy Covered
- Briefly explain:
- Quiz/Test

List of Instructors

	Name	VA Lic. No.	Education Experience	Resume?
	Susan Kavach		<input type="checkbox"/>	<input checked="" type="checkbox"/>
	Wane Kim		<input type="checkbox"/>	<input checked="" type="checkbox"/>
	Todd Wise		<input type="checkbox"/>	<input checked="" type="checkbox"/>
	Peter Pahno		<input type="checkbox"/>	<input checked="" type="checkbox"/>
	Ina Stroman		<input type="checkbox"/>	<input checked="" type="checkbox"/>
	Lucio Escobar Manuel Paredes Dan Tran		<input type="checkbox"/>	<input checked="" type="checkbox"/>

Record of Correspondence:

Letter Sent (i.e., Al ltr, mg ltr, approval ltr)

Date:

**Application
for
VA DPOR Program Training Provider**

September 17, 2014

Re: Application for Training Course Approval

Submit to: **Board for Contractors**
Department of Professional and Occupational Regulation
9960 Maryland Drive Suite 400
Richmond VA 23233-1485

Submit by: **Ace Tech Institute** (formerly Millennium Institute of Construction)
7777 Leesburg Pike Suite 205
Tysons Corner, VA 22043
Tel: (703) 298-2685/5789/4556
Email: contactUS@contractVA.com

< Contents >

Application Form	---	3 pages
#1. Course Syllabus	---	13 pages
#2. Instructor Information	---	9 pages
#3. Course Materials and Fees	---	17 pages
#4. Schedule Course Dates and Locations-		2 pages
#5. Course Completion Certificate	---	5 pages
#6. Online Course Information	---	7 pages

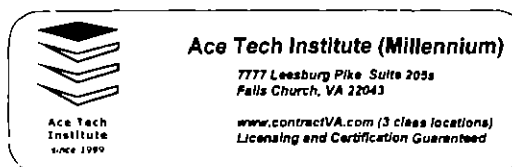



Board for Contractors
EDUCATION PROVIDER REGISTRATION/COURSE APPROVAL APPLICATION
No Fee Required

Select the action(s) you are requesting.

<input checked="" type="checkbox"/>	Registration Type:
<input type="checkbox"/>	Initial Provider Registration & Course Approval
<input checked="" type="checkbox"/>	Course Approval Application

1. Name of Provider Acc Tech Institute (formerly Millennium)
2. VA Contractor's Education Provider Registration Number (if applicable)

2	7	3	0	0	0	0	0	5	6
---	---	---	---	---	---	---	---	---	---
3. Mailing Address (PO Box accepted) 7777 Leesburg Pike Suite 205s
 If a mailing address is submitted, the mailing address will be printed on the license.
 Tysons Corner VA 22043
 City State Zip Code
4. Street Address (PO Box not accepted) Check here if Street Address is the same as the Mailing Address listed above.
PHYSICAL ADDRESS REQUIRED
7777 Leesburg Pike Suite 205s
 Tysons Corner VA 22043
 City State Zip Code
5. Email Address contactUS@contractVA.com
 (Email address are used for electronic communication from the Board. Owner/manager e-mail address are acceptable.)
6. Web Address www.contractVA.com
7. Contact Numbers

<u>(703) 298-2685</u> Primary Telephone	<u>(703) 298-5789</u> Alternate Telephone	<u>N/A</u> Fax
--	--	-------------------
8. Type of School/Provider (select only one)
 Privately owned school/provider Professional/Trade association Other _____
9. School Owner(s): Enter the name of the proprietor partnership, association, limited liability company, or corporation.
Limited Liability Company (LLC)
10. Name and Title of Contact Person Wane Kim / General Manager
11. Contact Person's Telephone Numbers (703) 298 2685
 Primary Telephone

12. Type of course to be offered (select all that apply)

- A. Contractor Pre-License Education
- B. Remedial Education
- C. Individual Vocational Training - (select all that apply)
 - Plumbing
 - Electrical
 - HVAC
 - Gas Fitter
 - Liquefied Petroleum Gas Fitter
 - Natural Gas Fitter Provider
 - Certified Elevator Mechanic
 - Certified Water Well Systems Provider
 - Certified Accessibility Mechanic
 - Certified Backflow Device Prevention Device Worker
- D. Continuing Education - (select all that apply)
 - Plumbing
 - HVAC/ Mechanical
 - Electrical
 - Gas Fitter
 - Certified Elevator Mechanic
 - Certified Water Well Systems Providers
 - Liquefied Petroleum Gas Fitter
 - Natural Gas Fitter Provider
 - Certified Accessibility Mechanic

13. Method of Instruction (select all that apply)

- Classroom
- Correspondence
- On-line
- Other distance learning, please describe _____

14. Course Information

Course Name	Course Hours	Subject (From items listed in #12; provide for each course listed)	OFFICE USE ONLY (COURSE NO.)	(Credit Hours)
Contractor Pre-License Education	8	Contractor Pre-License Educati		
Continuing Education	3	Plumbing		
Continuing Education	3	HVAC/ Mechanical		
Continuing Education	3	Electrical		
Continuing Education	1	Gas Fitter		

15. Instructor Information. Attach a resume for each instructor listed below.

Instructor's Name	Title	Phone Number
Susan Kovach, CPA	Instructor/Pre-License Education	703-944-8237
Wane Kim, MSCE	Instructor/Pre-License Education	703-298-2685
Todd Wise, LEED AP BD&C	Instructor/Plumbing, HVAC, Gas	202-607-7710
Peter Panno, PE	Instructor/ HVAC	703-916-0219
Ina Stroman, PE	Instructor/ HVAC	804-880-7000
Lucio Escobar, BSEE	Instructor/ HVAC	703-893-2484
Manuel Paredes, PE	Instructor/ ELE	703-732-4310
Dan Tran, PE	Instructor/ ELE	703-732-7637

Karina Ardon	Instructor/Pre-License Education	202-580-6672
--------------	----------------------------------	--------------

16. I, the undersigned, certify that the foregoing statements and answers are true, and I have not suppressed any information that might affect the Board's decision to approve this application. I certify that the provider has complied with all the laws of Virginia related to the education requirements under the provisions of Title 54.1, Chapter 11 of the Code of Virginia, the Board for Contractors Regulations, and the Board for Contractors Individual Licensing and Certification Regulations.

Responsible Manager (RM)

Print Name Wane Kim

Date Sept. 15, 2014

Signature



REQUIRED ATTACHMENTS FOR EACH COURSE

The following attachments must be provided for each course. Please include a spacer page to label each attachment according to the numbers listed below.

- **Attachment # 1: Course Syllabus** - The course syllabus lists the purpose of the course and the main topics covered in the course. This includes any specific code sections to be discussed in the continuing education course. Vocational training courses should include a detailed curriculum for the training program. Backflow prevention device worker vocational training programs must include instruction in a wet lab as part of the syllabus.
- **Attachment # 2: Instructor Information** - List all instructors for the course with applicable Virginia Tradesman, Individual Certification, or Contractor license numbers (if available). In addition, a one-page resume with appropriate teaching and technical experience must be included for each instructor.
- **Attachment # 3: Course Materials and Fees** - Information pertaining to any materials used or distributed during the course, including books, handouts, pamphlets, and slide presentations/overheads. If the materials are "custom" information, i.e. developed by the provider, please provide a copy. If you will be using materials developed by an outside source, please provide detailed information about the publication. A copy of the materials may be requested. Please provide the fees that will be assessed for the course and whether or not the fees include any materials for the course and, if not, the materials that students are required to furnish.
- **Attachment # 4: Schedule of Course Dates and Locations** - Provide information pertaining to the anticipated schedule and location(s) for the course. If you have not developed a schedule, please provide an anticipated start date for the program. Please note that you must provide the Board office with a final schedule and location(s) prior to holding the class.
- **Attachment # 5: Course Completion Certificate** - If students will be provided with a certificate of completion at the end of the course, please provide a copy marked "sample."
- **Attachment # 6: Online/Correspondence Course Information** - If an online or correspondence course, please provide information on the security procedures to be utilized. In addition, provide information on the test that will be given at the end of the course and security related to the test. Online providers must provide the website address, user ID, and password to be utilized by the Board during the review process in order to access your course. Correspondence course providers must provide a copy of the packet that will be distributed to students.

Breakdown Course Approval Application

	<u>Classroom</u>	<u>On-line</u> <u>New Applications</u>
A. Contractor Pre-License Education	Existing Course #2731001958	Yes, New Application
D. Continuing Education		
1. Plumbing	Yes, based on 2012 code changes <i>Ex. Course #2731001258</i>	Yes, New Application
2. HVAC/Mechanical	Yes, based on 2012 code changes <i>Ex. Course #2731001958</i>	Yes, New Application
3. Electrical	Yes, based on 2012 code changes <i>Ex. Course #2731001259</i>	Yes, New Application
4. Gas Fitter	Yes, based on 2012 code changes <i>Ex. Course #2731001957</i>	Yes, New Application

Remarks

- Total 9 applications submitted.
- 4 CE Courses are based on Code Changes of 2012 (VA DPOR Memorandum dated 8-8-2014).
- 5 new applications are based on new Online courses.

Course Syllabus

2

Instructor Information

3

Course Materials and Fees

Schedule of Course Dates and Locations

4

5

Course Completion Certificate

6. Online Course Information

A. Contractor Pre-license Education (On-line)

1. Requirement and Overview

Effective August 21, 2006, the Designated Employee or a member of Responsible Management of all contractors applying for initial licensure (for an entity that is not currently licensed) must successfully complete an 8-hour business class approved by the Board for Contractors.

This applies to Class-A, Class-B & Class-C Contractors. (Please note that individuals applying for a Class C license; A Owner/Officer/Partner of the Company must be the person to take the required 8-hour Business Course required by the Board.)

This course is required for all contractors applying for initial licensure (for an entity that is not currently licensed).

There is not an initial application needed, before passing the required Pre-Licensing Course.

Once you have successfully completed an 8 hour business course contact: Department of Professional and Occupational Regulation at [\(804\) 367-8511](tel:8043678511)

There is no reciprocity for this Pre-Licensing course.

Since this is a Pre-Licensing requirement, there are no Continuing Education requirements associated with it.

There is no examination required. Upon completion of this Pre-Licensing course, you will receive a certificate. We, Ace Tech, will submit your successful completion to the DPOR in Richmond. You will need to send a copy of this certificate with your completed license application.

The Pre-Licensing course content is as follows:

An Overview of

- VA Contractor Regulations
- Transaction Recovery Funds
- Uniform Statewide Building Codes (USBC)
- Business Organization and Structures
- Bidding and Estimating
- Construction Contract
- Financial Management
- Tax and Lien Laws
- Contractor License Application form overview
- PSI exam introduction – for Business and Specialty exams
- Virginia's Payment of Wage Law/

Students will leave this course with a better understanding of Virginia's expectations of its contractors and a Certification stating they have met the State Licensing Board requirements.

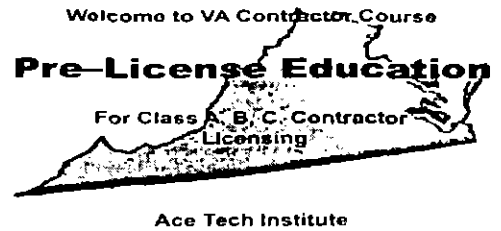

2. Class Schedule

Total 8 hours (400 minutes, based on 50 minutes per hour)

- Class Registration 10 min.
 Student Information

- Overview of VA Contractor Regulations 60 min.
 1. Definitions
 2. Contractor Licensing
 3. Contract Requirements
 4. Transaction Recovery Funds
 5. Uniform Statewide Building Codes (USBC)

- Overview of VA Contractor Requirements 30 min.
 1. Erosion and Sediment Controls
 2. Underground Utilities
 3. VA OSHA Regulations

- Your Business Practice Basics (Video-1) 80 min.
 1. Business Organization and Structures
 2. Bidding and Estimating
 3. Questions - 1

- Your Business Practice Basics (Video-2) 100 min.
 1. Construction Contract
 2. Project Management
 3. Risk Management
 4. Labor Laws
 5. Questions - 2

- Your Business Practice Basics (Video-3) 50 min.
 1. Financial Management
 2. Tax and Lien Laws
 3. Questions - 3

- PSI exam introduction – Business and Specialty Requirements 50 min.
- Questions and Answer/ Issuing the Pre-license Certificate 20 min.

D1. Plumbing (Classroom and On-line)

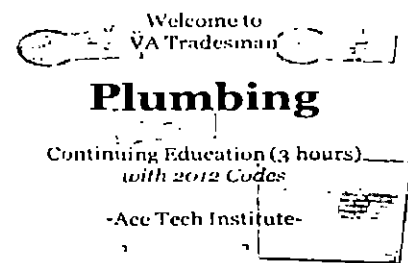

1. Overview

The Purpose of the VA continue education by VA DPOR is to familiarize contractors in the construction industry with many of the important changes in the 2012 International Mechanical Code (IMC), International Plumbing Codes (IPC), and International Fuel Gas Code (IFGC).

Our CE course is designed to assist you in identifying the specific code changes that have occurred and, more important, in understanding the reasons behind the changes. We hope to the course is to make it easy for your to track, follow, note, and follow up on code change topics.

Only the main portions of the total numbers of code changes are discussed. However, the importance of those changes not included is not to be diminished.

Your comments concerning this changes are encouraged and may be directed to the International Code Council (ICC) at significantchanges@iccsafe.org .

2. Class Schedule

Total 3 hours (150 minutes, based on 50 minutes per hour)

[International Plumbing Code]

1. Scope and Administration
2. Definitions

Grease Interceptor

Gravity Grease Interceptor

Plumbing Appliances

Plumbing Fixtures

Waterless drains

3. General Regulations

303.4 Third – Party Certification
Foundation Walls

304.4 Openings for Pipes
312.2 Drainage and Vent Air Test

305.3 Pipes through

- 315.1 Sealing of Annular Spaces
- 4. Fixtures, Faucets and Fixture Fittings
 - 403.1 Minimum Number of Required Fixtures
 - 403.2 Separate Facilities
 - 403.3.2 Toilet Room Location
 - 403.6 Door Locking
 - 405.3.1 Water Closets, Urinals, Lavatories and Bidets
 - 406.2 Automatic Clothes Waste Connection
 - 410.2 Minimum Number of Drinking Fountains
 - 410.4 Prohibited Locations (Drinking Fountains)
 - 410.2 Minimum Number of Drinking Fountains Substitution
 - 410.4 Prohibited Locations (Drinking Fountains)
 - 410.3 Drinking Fountains
 - 410.3 Drinking Fountains
 - 416.5 Tempered Water for Public Hand-Washing Facilities
 - 424.9 Water Closet Personal Hygiene Devices
 - 403.1.3 Marina Fixtures
 - 403.2.1 Family or Assisted – Use Toilet Serving as Separate Facilities
 - 403.3 Required Public Toilet Facilities
 - 403.3.3 Location of Toilet Facilities in Occupancies Other Than Malls
 - 403.3.4 Location of Toilet Facilities in Malls
 - 403.5 Drinking Foundation Location
 - 405.3.2 Public Lavatories
 - 407.2 Bathtub Waste Outlets and Overflows
 - 416.5 Tempered Water for Public Hand-Washing Facilities
- 5. Water Heaters
 - 504.7 Required Pan Water Heaters Installed in Garages
 - 504.7 Required Pan Water Heaters Installed in Garages Water Supply and Distribution
 - 605.25 Polyethylene of Raised Temperature Plastic Means
 - 607.1.1 Temperature Limiting Means
 - 607.2 Hot or Tempered Water Supply to Fixtures
 - 607.5 Pipe Insulation
 - 608.8 Identification of Non-Potable Water Breakers
 - 608.13.8 Pressure Vacuum Breakers
 - 608.14 Location of Backflow Preventers
 - 608.16.6 Connections Subject to Back-Pressure
 - 608.16.10 Coffees Machines and Noncarbonated Beverage Dispensers
 - 607.1.1 Temperature Limiting Means
- 7. Sanitary Drainage
 - 706.2 Obstructions
 - 709.1 Drainage Fixture Units for Fixtures and Groups
 - 712.3.3 Sumps and Ejectors Discharge Pipe and Fittings
 - 712.3.3.2 Ratings
- 8. Indirect/Special Waste
 - 802.1.8 Food Utensils, Dishes, Pots and Pans Sinks
 - 802.2 Installation
 - 802.2 Installation – Exception
 - 802.3 Waste Receptors
- 9. Vents
 - 901.3 Chemical Waste Vent Systems
 - 903.5 Location of Vent Terminal
 - 915 Combination Waste and Vent System
 - 917 Single Stack System
- 10. Traps, Interceptors and Separators

1003.1 Interceptors and Separators Where Required and Automatic Grease Removal Devices Required 1003.3.1 Grease Interceptors

11. Storm Drainage

1107 Symphonic Roof Drainage Systems 1108 Secondary Roof Drains

13. Referenced Standards

Non-Potable Water Systems Reclaimed Water Definition Rainwater Definition
Gray Water Definition Definition Non-Potable and Outlets
Non-potable Fixtures and Outlets Definition Storm Water

D2. HVAC/Mechanical (Classroom and On-line)

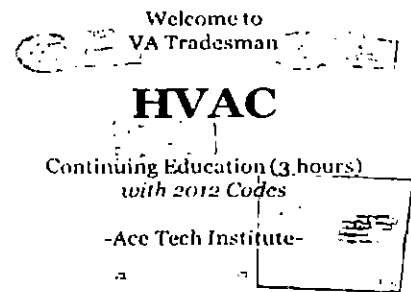

I. Overview

Our collective concerns about the future health of the environment are at the heart of today's dynamic Heating, Ventilation, and Air Conditioning Technology industry, driving progressive changes through planning and implementation.

The shift away from some of the more conventional HVAC systems still used in older residences and commercial buildings has been dramatic and continues to evolve.

Newer systems focus on renewable energy sources, energy efficiency, and creating comfortable indoor environments.

One of the primary objectives of the HVAC curriculum is to introduce students to Green Technology concepts as they apply to HVAC systems. Students are prepared to confidently enter this vibrant field possessing fundamental skills required to service, troubleshoot, and repair commercial and residential indoor HVAC air management systems. Students also learn proper refrigerant recovery and recycling techniques, and are encouraged to complete Environmental Protection Agency (EPA) certification testing.

Upon completion of this program, students can expect to meet the essential entry-level skills and knowledge required of an HVAC technician. With additional experience graduates may pursue opportunities allowing them to work independently, without direct supervision, supervise crews or teams of other technicians, or start their own business. Graduates may also choose to specialize in one or more specific areas of the HVAC market including refrigeration, air conditioning, and heating.

II. Class Schedule

Total 3 hours (150 minutes, based on 50 minutes per hour)

International Mechanical Code

1. Scope and Administration
2. Definitions

- 3. General Regulations
 - 301.3 Identification
 - 301.4 Plastic Pipe, Fittings and Components
 - 301.5 Third-Party Testing and Certification
 - 301.9 Label Information
 - 301.16 Flood Hazard
 - 304.3 Elevation of Ignition Source
 - 306.5 Equipment and Appliances on Roofs or Elevated Structures
 - 308.5 Labeled Assemblies
- 4. Ventilation
 - 401.4 Intake Opening Location
 - 403.3 Outdoor Airflow Rate
 - 404.1 Enclosed Parking Garages
- 5. Exhaust Systems

Transfer Air	Makeup Air Required	Location
501.2 <i>Independent System Required</i>	501.3.2 <i>Exhaust Opening Protection</i>	
504.8 Common Exhaust Systems for Clothes Dryers Located in Multistory Structures		
505.1 Domestic Systems	505.3 Other Group R	
506.3.7.1 Grease Reservoirs	506.3.8 Grease Duct Cleanouts and Other Openings	
506.3.9 Grease Duct Horizontal Cleanouts		
506.3.10 Underground Grease Duct Installation		
507.2 Where Required	507.2.1 Type I Hoods	
507.2.1.2 Exhaust Flow Rate Label	507.2.2 Type II Hoods	
507.2.3 Domestic Cooking Appliances Used for Commercial Purposes		
507.10 Hoods Penetrating a Ceiling	507.11 Grease Filters	
510.7 Suppression Required	514 Energy Recovery Ventilation Systems	
514.4 Recirculated Air		
- 6. Duct Systems
 - 601.4 Contamination Prevention
 - 602.2.1 Materials within Plenums
 - 603.7 Rigid Duct Penetrations
 - 603.9 Joins, Seams, and Connections
 - 603.17 Dispersion Systems
- 7. Combustion Air
- 8. Chimney and Vents
 - 804.3 Mechanical Draft Systems
 - 805.3 Factory-Built Chimney Offsets
- 9. Specific Appliances, Fireplaces, and Solid-fuel-burning
 - 901.4 Fireplace Accessories
 - 903.2 Hearth Extensions
 - 908.5 Water Supply
 - 927 (New) Radiant Heating Systems
 - 928 Evaporative Cooling Equipment
 - 928.1 General, Evaporative cooling equipment shall
- 11. Refrigeration
 - 1105.6.3 Ventilation Rate

D3. Electrical (Classroom and On-line)

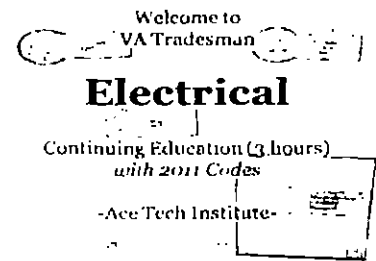

1. Overview

New to the 2011 national Electrical Code changes are articles including first-time Article 399 on Overhead Conductors with over 600 volts, first-time Article 694 on Small Wind Electric Systems, first-time Article 840 on Premises Powered Broadband Communications Systems, and more.

Air Conditioning and Refrigeration Controls presents electron theory, magnetism, Ohm's Law, resistance, current flow, instruments for **electrical** measurement, A.C. motors, power distribution controls and their application. Circuits and Controls presents circuit diagrams for air conditioning units, reading and drawing of circuit diagrams, types of **electrical** controls. Includes analysis of air conditioning circuits, components, analysis and characteristics of circuits and controls, testing and servicing. Introduces electricity for air conditioning which includes circuit elements, direct current circuits and motors, single and three-phase circuits and motors, power distribution systems, and protective devices. Studies the electron and its behavior in passive and active circuits and components. Demonstrates electronic components and circuits as applied to air conditioning system. Air Conditioning and Refrigeration Controls introduces **electrical**, pneumatic and electronic control circuits as applied to year-round air conditioning systems. Includes reading wiring and schematic diagrams, troubleshooting, and designing high and low voltage control systems.

2. Class Schedule

Total 3 hours (150 minutes, based on 50 minutes per hour)

National Electrical Code 2011

90. Introduction

90.5 Explanatory Material and Annexes

100. Definitions

Automatic / non-automatic

Bathroom

Service Definitions

110. Requirements for Electrical Installations

110.14 Electrical Connections 110.24 Available Fault Current 110.26 Height of Working Space
 200. Use and Identification of Grounded
 200.4 Neutral Conductors 200.7 White Conductor Identification
 210. Branch Circuits
 210.5 Identification of Ungrounded Conductors
 220. Branch – Circuit, Feeder and Service Calculations
 220.43 Exception – Track Lighting
 225. Outside Branch Circuits and Feeders
 225.27 Raceway Seals 225.30 Number of Supplies
 230 Services
 230.6 Conductors Considered Outside the Building
 240 Overcurrent Protection
 240.87 Non – instantaneous Trip 240.91 (B) Devices Rated over 800 Amperes
 250 Grounding and Bonding
 250.2 Definitions Supply Side Bonding Jumper 250.21(C) Marking – Undergrounded Systems
 300. Wiring Methods
 300.4(E) Raceways Under Roof Decking 300.4(H) Structural Joints Am pacity Tables enumerated
 310. Conductors for General Wiring
 310.15(B) (3) (a) More than Three Current Carrying Conductors
 314 Outlet, Device, Pull, and Junction Boxes; Conduit Bodies; Fittings; and Handhole Enclosures
 314.27(C) Boxes Ceiling Suspended (Paddle) Fan Outlets
 334. Nonmetallic-Sheathed Cable: Types NM, NMC, and NMS
 334.10(1) Uses Permitted (NM Cable)
 338. Service-Entrance Cable: Types SE and USE
 338.10(B) (4) (a) Interior Installations (SE cable)
 399 Outdoor, Overhead Conductors, Over 600V
 404. Switches
 404.2(C) Switches Controlling Lighting Loads
 406 Receptacles, Cord Connectors, and attachment plugs (Caps)
 406.4(D) (4) AFCI Protection 406.4(D) (5) Tamper Resistant Receptacles
 408. Switchboards and Panelboards
 408.4(B) Source of Supply (Identification)
 409. Industrial Control Panels
 409.110(3) Marking (industrial control panels)

- 410. Luminaires (Lighting Fixtures), Lampholders, and Lamps
 - 410.130(G) (1) Disconnecting Means (luminaires)
- 430. Motors, Motor Circuits, and Controllers
 - 430.22(G) Conductors for Small Motors
- 450. Transformers and Transformer Vaults (including Secondary Ties)
 - 450.14 Transformer Disconnect
- 514. Motor Fuel Dispensing Facilities
 - 514. Circuit Disconnects
- 517. Health Care Facilities
 - 517.13(B) Grounding of Receptacles in Patient Care Areas
- 555. Marinas and Boatyards
 - 555.3 Marinas – Ground Fault Protection
- 590. Temporary Installations
 - 590.6(A) (3) Receptacles on 15KW or less Portable Generator
- 600. Electric Signs and Outline Lighting
 - 600.33 LED Signs
- 625 Electric Vehicle Charging System
 - 625.2 Definitions
- 645. Information Technology Equipment
 - 645.2 Definitions (ITE)
 - 645.10 Disconnecting Means
- 670. Industrial Machinery
 - 670.5 Short Circuit Current Rating
- 680. Swimming Pools, Fountains, and Similar Installations
 - 680.2 Low Voltage Contact Limit
 - 680.10 Underground Wiring Locations – Minimum Cover Depths
- 690. Solar Photovoltaic Systems
 - 690.4(B) Identification and Grouping
 - 690.4(E) Wiring and Connections
- 694 – Small Wind Electric Systems
- 695. Fire Pumps
 - 695.3 Fire Pump Power Source(s)
 - 695.4(B) (3) – Disconnecting Means – Features and Location – Onsite Standby Generator
- 700. Emergency Systems
 - 700.10(D) (1) – Fire Protection (emergency feeders)
 - 700.24 Automatic Load Control Relay
- 701. Legally Required Standby Systems
 - 701.6(D) – Signals – Ground Fault (legally required systems)

760. Fire Alarm Systems

760.41/760.121 (A) and (B)

800. Communications Circuits

800.2 Definitions

800.3/810.3/820.3 Other Articles

D4. Gas Fitter (Classroom and On-line)

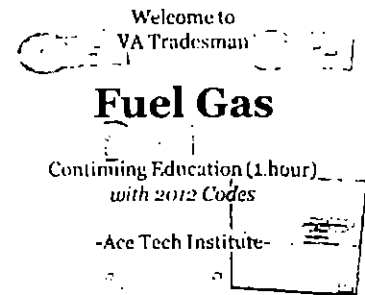

1. Overview

Continuing Education for Tradesmen-Gas Fitters

Journeyman, Master Plumbers, Electricians, HVAC mechanics, and Gas Fitters are now required by the Virginia Board for Contractors to take a pre-determined number of *continuing education hours specific to their trade as part of the licensing process. Anyone* obtaining or renewing a license must take continuing education in his/her respective profession. Plumbers, HVAC technicians and Electricians must take three hours of continuing education in their field. Gas fitters must take one hour. (This one hour class for Gas Fitters is intended for Journeyman and Master Gas Fitters, Liquefied Petroleum Gas Fitters, and Natural Gas Fitters.) Each course covers new definitions, code changes, general requirements, impacts on the job, general use and special equipment included in the respective codes. These classes are recognized by the Commonwealth of Virginia's Department of Professional and Occupational Regulation and the Virginia Board for Contractors. Once you complete this online course, your instructor will send you a completion email. The information will then be forwarded to DPOR.

The International Fuel Gas Code (IFGC) applies to the installation of fuel gas piping systems, fuel gas utilization equipment, gaseous hydrogen systems, and related accessories.

2. Class Schedule

Total 1 hours (50 minutes, based on 50 minutes per hour)

International Fuel Gas Code 2012

1. Scope and Administration
2. Definitions (IFGC & IRC)

3. General Regulations

301.11 Flood Hazard 306.5 Equipment and Appliances on Roofs or Elevated Structures
308.1 Scope 308.3.4 Clearance from Supply Ducts 310.1.1 CSST

4. Gas Piping Installation

401.9 Identification 401.10 Third –Party Testing and Certification

404.1 Installation of Materials 404.2 CSST 404.18 Prohibited Devices

406.1.6 Pipe Clearing 406.7 Purging 408.4 Sediment Trap

410.4 Excess Flow Valves 410.5 Flashback Arrestor Check Valve

5. Chimneys and Vents

503.2.5 Incinerators 504.2.9

6. Specific Appliances

636 Outdoor Decorative Appliances

2. Instructor Information

One-page Resume or Instructor Qualification Form included

(Individual Full Resume available upon request)

A. Contractor Pre-License Education	Susan Kovach	Wane Kim	Karina Ardon
D. Continuing Education			
1. Plumbing	Todd Wise		
2. HVAC/Mechanical	Pete Pahnó	Ina Stroman	Todd Wise
3. Electrical	Manuel Paredes	Dan Tran	Lucio Escobar
4. Gas Fitter	Todd Wise		

SUSAN KOVACH, CPA, CGMA

3312 Military Drive
Falls Church, VA 22044

Phone #: (703) 992-0099 (Home) (703) 944-8237 (Cell)

E-mail: susankim1108@gmail.com

EXPERIENCE SUMMARY

Expertise in general ledger, financial reports, financial analysis, budget and forecasting, cash management, AR & AP, fixed assets, payroll, job costing, taxes, internal control and audits. Extensive teaching experiences in government contracting, banking, mortgage, real estate & construction. Familiar with FAR, DFAR, GAGAS, DoD Financial Management Regulation, CAS, Incurred Costs Submission, DCAA Regulation and Audits. Over twenty years of experience in accounting and finance.

EDUCATION

B.S. in Accounting- University of Maryland, 1990

Master's Certificate in Government Contracting- George Washington University, School of Business, 2012

REGISTRATIONS/CERTIFICATIONS

CPA, License #30320, Virginia CPA, License #CPA029126, Georgia

TECHNICAL SKILLS

Government contracting, business plan review, job costing, banking, mortgage, real estate & construction

Proficient in Microsoft Windows Applications (Word, Excel & PowerPoint)

Oracle, Timberline, Deltek GCS Premier, Quick Books, BNA Fixed Assets

CURRENT EMPLOYMENT

02/2014 –Present: Senior Systems Analyst

St. Michaels, Inc., Woodbridge, VA – Government Contracting, DoD

Responsible for the Corrective Action Plan (CAP) of the PP&E section of the Balance Sheet including Internal Use Software (IUS), Equipment, Construction-in-Progress, Leases and Leasehold improvements for the Audit Readiness Program at Defense Intelligence Agency as a Senior Member of the Integrated Audit Team (IAT). Supervise the work of junior accountants.

TEACHING EXPERIENCE

October 2013 - Present: Contractor Prelicense Education instructions

Ace Tech Institute

Fall Session (Aug. 22 – Nov. 18, 2012): English as a Second Language, Level 1

Hope Lutheran Church, 4604 Ravensworth Rd, Annandale, VA 22003

Mar. – Jun. 2007: English as a Second Language, Level 2

Reston Interfaith, 2244 Stone Wheel Dr, Reston, VA 20191

May 1993 – Aug. 1995: CPR & First Aid

American Red Cross, Kadena AFB, Okinawa, Japan

SCHEV
James Monroe Building
101 North Fourteenth Street
Richmond, Virginia 23219



State Council of
Higher Education for Virginia

Phone: (804) 225-2600
Fax: (804) 225-2604
TDD: (804) 371-8017
Web: www.schev.edu

Instructor Qualification

Personnel Data					
Full Name:	Kim	Wane	D	Date:	Sept. 15, 2014
	<i>Last</i>	<i>First</i>	<i>M.I.</i>		
Phone:	(703) 298-2685		Work Cell #:	(703) 298-5789	
Work Fax:	()		E-mail Address:	contactUS@contractVA.comJune	
Date of Initial Employment:	June, 1999	Full Time:	<input checked="" type="checkbox"/>	Part Time:	<input checked="" type="checkbox"/>
Name of School (Employer):	Ace Tech Institute (formerly Millennium Institute of Construction)				
Courses that will be taught:	Kept teaching construction management related courses, including VA and MD statewide contractor licensing exam preps. Business and Office management skills incl.				

Education						
Institution Attended (Name plus city & state of location)	Graduated?		Certificate, Diploma or Degree Earned	Major Area of Study	Dates Attended	
	Yes	No			From (Mo/Yr.)	To (Mo/Yr.)
University of Maryland	<input checked="" type="checkbox"/>	<input type="checkbox"/>	Master of Science	Construction Mgmt	Sept. '86	May 91
Inha University	<input checked="" type="checkbox"/>	<input type="checkbox"/>	Bachelor of Scienc	Civil Engineering	Mar. '74	Feb 78
	<input type="checkbox"/>	<input type="checkbox"/>				

Teaching and or Work Experience					
Employer	US Department of State		Job Title:	Construction Manager	
Address:	1705 Fort Myer Dr., Arlington, VA 22019				
Subject Taught:	Overseas Embassy construction control, budget to Congress, constr. cost control				
Job Duties or Responsibilities:					
Length of Work Experience	From:	May, 2000	To:	Oct. 2012	

Employer	Ace Tech Institute		Job Title:	Director	
Address:	7777 Leesburg Pike Suite 205s				
Subject Taught:	Many construction management related subjects - Statewide contractor licensing teach.				
Job Duties or Responsibilities:	Daily operation and in charge of all daily classes plan, excution and performance.				
Length of Work Experience:	From:	Jan. 1999	To:	Present	

Attach separate sheet with additional work experience

KARINA ARDON
7818 LELAND ROAD
MANASSAS, VA 20111
KARINA_ARDON@COMCAST.NET
CELL: 202-870-6640

CAREER SNAPSHOT

- Tri-lingual capabilities to include written & verbal proficiency in Spanish & French (native language).
- Expert in customer care/communications, problem solving, relationship building, training, support.
- Proficiency in various databases for property management, Quickbooks as well as MS Word. 20+ years of commended performance in customer service & managerial roles.

AWARDS

Cardinal Management Group 2005 "Manager of the Year"

DESIGNATIONS/MEMBERSHIP

- Notary Public, since 2002
- Birthright of Manassas, volunteer since 2005
- Community Association Institute, member 2001-2011

CERTIFICATION/LICENSES

- AMS
- CMCA
- Class A Virginia Contractor's License-Designated Employee

EDUCATION

- 1992-1993 Travel & Tourism Certificate, NVCC
- 2001- 2011-Community Association Institute

PROFESSIONAL EXPERIENCE

2011-Present **PT Instructor, Ace Tech Institute (Millennium)**

- Teaching of the Virginia Class A/B Contractor's License Class & Home Improvement Certification.

TODD D. WISE

3701 Michele Ct. Oakton, Virginia 22124
(202) 607-7710

Responsibilities:

For over 30 years I have been responsible for the facilities management of commercial buildings to include the operation and maintenance. This has included owner operated and fee managed buildings and facilities. I have extensive experience with class A+ office buildings with additional experience in office flex spaces, retail, central plants and computer rooms. My work experience has included training, monitoring, supervising engineering and facility management personnel in the building engineering and management fields.* I have oversee capital and construction management; * Operations of 35+ commercial office buildings over 1.5 million + square foot. *I have managed an engineering crew of 15+ and supported 5 property managers and 5 leasing managers and support staff. I perform building inspections, monthly reporting, sub meter invoicing, tenant issue resolutions, negotiate and oversee building service contracts, supplies, estimate bid and review plans for tenant build outs. Assist with leasing tours and review work letters, tenant build out plans and budgets. I have been responsible for commissioning new and existing properties, energy audits, ADA review and surveys. I have saved my employers a great deal of money by my teams review and value engineering the construction and capital projects. Also by reducing engineering cost by re structuring the engineering department and how work is handled, staffing and scheduling. The engineering team's creation of profit center for electrical and HVAC usage has been very successful and profitable.

My responsibilities have also included

- 5 year budget preparation, plans and reports
- Building Commissioning
- Energy efficient, energy star, LEED, green building operations and retrofit
- Energy Star certifications and setup
- Environmental health and safety review, inspection and remediation

EMPLOYMENT

Chief Engineer CB Richard Ellis- Washington DC	2010 - Present
Manager of Engineering Services PS Business Parks- Fairfax, Virginia	2001 to 2010
Senior Chief Engineer CB Richard Ellis- Fairfax, Virginia	1996 to 2001
Chief Engineer Ogden Government Services- Silver Spring, MD	1994 to 1996

Thank you
Todd D. Wise
Pm Wise LLC
202-607-7710 Cell
571-281-6829 Fax

VA Class A license #2705072627A
VA BLDG
DC 3rd Steam license
BOMI RPA & FMA
VA Real State Licence

VA Master HVAC, Plumbing, Gas
MD Master HVAC & 1st class Steam license
LEED AP BD&C
CFM (Certified Facility Manager)
SWaM#689147

SCHEV
James Monroe Building
101 North Fourteenth Street
Richmond, Virginia 23219



State Council of
Higher Education for Virginia

Phone: (804) 225-2600
Fax: (804) 225-2604
TDD: (804) 371-8017
Web: www.schev.edu

Instructor Qualification

Personnel Data					
Full Name:	PAHNO	PETER	G	Date:	Aug. 30, 2014
	<i>Last</i>	<i>First</i>	<i>M I</i>		
Phone:	(703)916 - 0219		Work Cell #:	(703)401 - 4624	
Work Fax:	()		E-mail Address:		
Date of Initial Employment:	DEC, 2012	Full Time:	<input type="checkbox"/>	Part Time:	<input checked="" type="checkbox"/>
Name of School (Employer):	Ace Tech Institute				
Courses that will be taught:	HVAC MASTER PREP.				

Education						
Institution Attended (Name plus city & state of location)	Graduated?		Certificate, Diploma or Degree Earned	Major Area of Study	Dates Attended	
	Yes	No			From (Mo/Yr.)	To (Mo/Yr.)
VIRGINIA TECH.	<input checked="" type="checkbox"/>	<input type="checkbox"/>	B.S.	Mechanical Eng.	06/88	12/90
	<input checked="" type="checkbox"/>	<input type="checkbox"/>				
	<input type="checkbox"/>	<input type="checkbox"/>				

Teaching and or Work Experience					
Employer	ACE TECH INSTITUTE			Job Title:	INSTRUCTOR
Address:	7777 LEESBURG PIKE, FALLS CHURCH, VA 22043				
Subject Taught:	HVAC PREP				
Job Duties or Responsibilities:	Teaching 30 hr		3Hrs Lecture		
Length of Work Experience	2 year	From:	12/12	To:	PRESENT

Employer	WEISAND ASSOCIATES			Job Title:	DESIGN ENG.
Address:	20270 GOLDENROD LANE, GERMANTOWN, MD				
Subject Taught:					
Job Duties or Responsibilities:	DESIGN HVAC SYSTEMS FOR EDUCATIONAL FACILITIES				
Length of Work Experience:	3 year	From:	3/2011	To:	Present

Attach separate sheet with additional work experience

Bid price Questions

(Chapter -7)

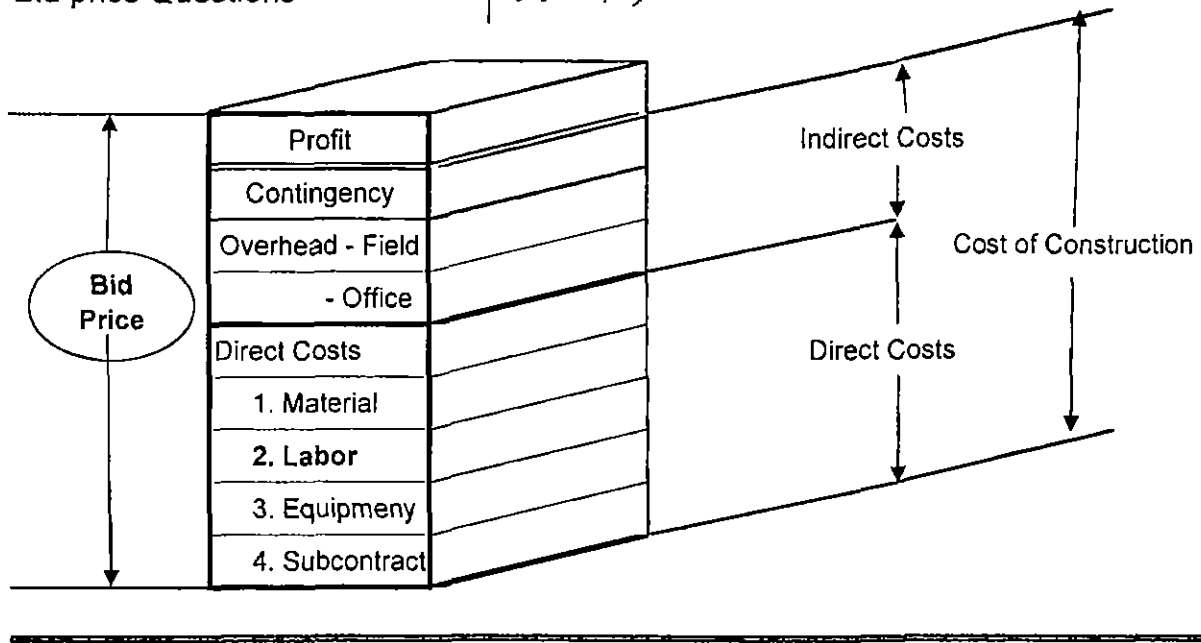

= figured

Q1. A job has a bid price of \$165,000 after direct cost and overhead are factored. What will the final bid be if the profit markup is 11.5%?

1. \$186,440 2. \$183,975 3. \$189,874 4. \$179,545

Answer:	Cost of Construction	\$165,000
	Profit	$\$165,000 \times 11.5\% =$
	Bid price	<u>\$183,975</u>

Wrong Answer	Cost of Constr.	$(100\% - 11.5\% = 88.5\%)$	\$165,000
	Profit	11.50%	
	Bid price	$(\$165,000 / 0.885)$	<u>\$186,440</u>

Q2. A job has direct costs of \$198,325, Project overhead of 9.2%, Company overhead of 13.9%, and a desired profit of 10.7%. What will be the correct bid be?

1. \$265,358 2. \$288,914 3. \$276,325 4. \$299,584

Answer:	Direct costs	\$198,325
	All others $(9.2\% + 13.9\% + 10.7\% = 33.8\%)$	<u>\$67,033</u>
	Bid price	<u>\$265,358</u>

Wrong Answer	Direct costs	$(100\% - 33.8\% = 66.2\%)$	\$198,325
	All others $(9.2\% + 13.9\% + 10.7\% = 33.8\%)$		
	Bid price	$(\$198,325 / 0.662)$	<u>\$299,584</u>

SCHEV
James Monroe Building,
101 North Fourteenth Street
Richmond, Virginia 23219



State Council of
Higher Education for Virginia

Phone: (804) 225-2600
Fax: (804) 225-2604
TDD: (804) 371-8017
Web: www.schev.edu

Instructor Qualification

Personnel Data

Full Name:	Paredes	Manuel	I	Date:	6/23/2014
	<i>Last</i>	<i>First</i>	<i>M.I.</i>		
Phone:	(703) 732-4310		Work Cell #:	()	
Work Fax:	()		E-mail Address:	manuelparedespe@yahoo.com	
Date of Initial Employment:	9/2013	Full Time:	<input type="checkbox"/>	Part Time:	<input checked="" type="checkbox"/>
Name of School (Employer):	ACE Tech Institute				
Courses that will be taught:	Basic Electrical Theory, and Residential and Commercial Electrical Wiring				

Education

Institution Attended (Name plus city & state of location)	Graduated?		Certificate, Diploma or Degree Earned	Major Area of Study	Dates Attended	
	Yes	No			From (Mo/Yr.)	To (Mo/Yr.)
Georgia Institute of Tech	<input checked="" type="checkbox"/>	<input type="checkbox"/>	Power System	Electrical Engineeri	5/2007	5/2012
New York Institute of Tec	<input checked="" type="checkbox"/>	<input type="checkbox"/>	MSEE	Electrical Engineeri	9/1995	6/1997
New York Institute of Tech	<input checked="" type="checkbox"/>	<input type="checkbox"/>	BSEE	Electrical Engineeri	9/1993	6/1995

Teaching and or Work Experience

Employer	Whitman, Requardt & Associates		Job Title:	Project Engineer-Electrical	
Address:	3701 Pender Drive, Suite 450, Fairfax, VA 20230				
Subject Taught:	Electrical Engineering				
Job Duties or Responsibilities:	Electri	Power and Ligh	Design for Buildings and facilities		
Length of Work Experience	2	From:	10/2012	To:	Present

Employer	MCDean		Job Title:	Senior Electrical Engineer	
Address:	26241 Shaw rd, Dulles, VA 20166				
Subject Taught:	Electrical Engineering				
Job Duties or Responsibilities:	Electrical Power and Lighting Design for Buildings and Facilities. Engineering Studies				
Length of Work Experience:	4	From:	7/2008	To:	1/2012

Attach separate sheet with additional work experience

SCHEV
James Monroe Building
101 North Fourteenth Street
Richmond, Virginia 23219



State Council of
Higher Education for Virginia

Phone: (804) 225-2600
Fax: (804) 225-2604
TDD: (804) 371-8017
Web: www.schev.edu

Instructor Qualification

Personnel Data					
Full Name:	Tran	Dat	M	Date:	06/24/2014
	<i>Last</i>	<i>First</i>	<i>M.I.</i>		
Phone:	(703-732-7637)		Work Cell #:	(703-732-7637)	
Work Fax:	()	E-mail Address:	ddtranpe@msn.com		
Date of Initial Employment:		Full Time:	<input type="checkbox"/>	Part Time:	<input checked="" type="checkbox"/>
Name of School (Employer):	Ace Tech Institute				
Courses that will be taught:	Master Electrical Exam Review, Journeyman Exam review, NEC codes.				

Education						
Institution Attended (Name plus city & state of location)	Graduated?		Certificate, Diploma or Degree Earned	Major Area of Study	Dates Attended	
	Yes	No			From (Mo/Yr.)	To (Mo/Yr.)
Old Dominion University	<input checked="" type="checkbox"/>	<input type="checkbox"/>	BSET	Electrical	12/1994	12/98
Northern Virginia College	<input checked="" type="checkbox"/>	<input type="checkbox"/>	AAS	Elect/Mech	12/84	12/88
	<input type="checkbox"/>	<input type="checkbox"/>				

Teaching and or Work Experience					
Employer	Department of VA		Job Title:	Senior Electrical engineer	
Address:	425 I street, NW, Washington, DC 20001				
Subject Taught:	National Electrical Codes, NFPA, Arc Flash and electrical power distribution systems				
Job Duties or Responsibilities:	Engineering		Consulting, Review for Hospitals.		
Length of Work Experience	8 year	From:	7/2007	To:	Present

Employer	E.K. Fox Associates		Job Title:	Chief Electrical Engineer	
Address:	4035 Ridge Top Rd # 650, Fairfax, VA 22030				
Subject Taught:	National Electrical Codes, NFPA, Arc Flash and electrical power distribution systems				
Job Duties or Responsibilities:	Electrical engineering, supervisor, training.				
Length of Work Experience:	4 year	From:	2004	To:	2007

Attach separate sheet with additional work experience



Instructor Qualification

Personnel Data					
Full Name:	ESCOBAR LUCIO		Date:	Aug. 25, 2014	
	<i>Last</i>	<i>First</i>	<i>M.I.</i>		
Phone:	(571)237 - 4487		Work Cell #:	(703)827 - 8388	
Work Fax:	(703)893 - 2484		E-mail Address:	escobl2@yahoo.com	
Date of initial Employment:	JUN, 2014	Full Time:	<input type="checkbox"/>	Part Time:	<input checked="" type="checkbox"/>
Name of School (Employer):	Ace Tech Institute				
Courses that will be taught:	HVAC/ELE BASIC OF AIR CONDITIONING, HEATING, CONTROL				

Education						
Institution Attended (Name plus city & state of location)	Graduated?		Certificate, Diploma or Degree Earned	Major Area of Study	Dates Attended	
	Yes	No			From (Mo./Yr.)	To (Mo./Yr.)
Virginia Apprenticeship	<input checked="" type="checkbox"/>	<input type="checkbox"/>	Certificate Diploma	Electrical Control	02/1996	9/1999
Virginia Apprenticeship	<input type="checkbox"/>	<input checked="" type="checkbox"/>		HVAC I, II, III	02/1989	9/1991
University of Sansal	<input type="checkbox"/>	<input checked="" type="checkbox"/>		Electrical Eng.	03/1978	9/1980

Teaching and or Work Experience					
Employer	ACE TECH INSTITUTE			Job Title:	INSTRUCTOR
Address:	7777 LEESBURG PIKE, FALLS CHURCH, VA 22043				
Subject Taught:	HVAC PREP				
Job Duties or Responsibilities:	Teach HVAC Basic				
Length of Work Experience	4 moth	From:	05/14	To:	PRESENT

Employer	THE COLONIES CONDOMINIUM OF MCLEAN			Job Title:	CHIEF ENGINEER
Address:	7681 PROVIDENCIAL DR MCLEAN, VIRGINIA 22102				
Subject Taught:	HVAC HEAT PUMP, BOILER, PLUMBING, ELECTRICAL				
Job Duties or Responsibilities:	DESIGN HVAC SYSTEMS FOR EDUCATIONAL FACILITIES				
Length of Work Experience:	31yrs	From:	1983	To:	Present

Attach separate sheet with additional work experience

A. Contractor Pre-license (On-line)

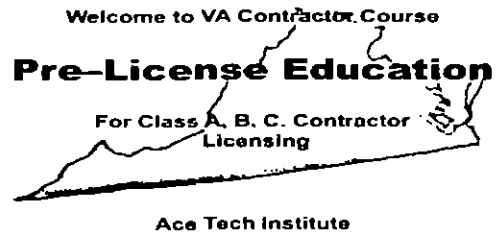

You have the option of buying your own books at cost from us or borrow them free of charge during the class. You can also download the material for free if you are taking on-line class.

Course Material – Purchase is optional, or borrow them during the class.

1. Virginia Contractor's Law (optional)

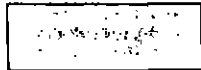
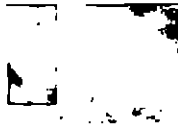

Book Cost \$65

2. FREE Printable Copies (all online students) Free
- VA Regulation of Contractors, USBC Copies, License Application

<u>Class Cost</u>	<u>Online</u>
Class Cost (include above free prints)	\$89
Book (Optional)	
- <u>Virginia Contractor's Law</u>	<u>\$65</u>
Sub Total with Optional books	\$154

D1. Plumbing (Classroom and On-line)

You have the option of buying your own books at cost from us or borrow them free of charge during the class. You can also download the material for free if you are taking on-line class.

Course Material – Purchase is optional, or borrow them during the class.

1. 2012 Virginia Plumbing Code (optional)

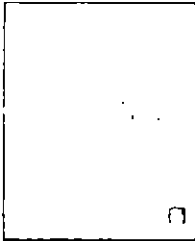

Book Cost \$75

2. Significant Changes to Int'l Plumbing Code 2012 (Optional)



Book Cost \$45

3. 2012 Code Change Summary Guide 16 page Summarized Code Changes, as attached (Available to all students)

Free

<u>Class Cost</u>	<u>Classroom</u>	<u>Online</u>
Class Cost (include above 15 page Summary)	\$89	\$39
Books (Optional)		
- 2012 Virginia Plumbing Code	\$75	\$75
- <u>Significant Changes to Int'l Plumbing Code 2012</u>	\$45	\$45
Sub Total with Optional books	\$209	\$159

PLUMBING

2012 IPC, 2012 IRC & 2012 VRC

IPC Definition: Hydromechanical Grease Interceptor

- Plumbing appliances installed to intercept fats, oils, and greases by air entrapment, buoyancy, and interior baffling



IPC Definition: Gravity Grease Interceptor

- Plumbing appliance not less than 500 gallons and separation of fats, oils, and greases by gravity during a retention time of less than 30 minutes



IPC Definition: Plumbing Appliance

- Clarifies that a fixture is not an appliance. Examples of appliances include water heaters, hot water dispensers, garbage disposals, dishwashers, clothes washers, and water softeners



IPC and IRC Definition: Plumbing Fixture

- Clarifies that a fixture is a receptacle or device that is connected to a water supply system or discharges to a drainage system or both

Examples:

- water closets
- bathtubs



303.4 and P2609 Third-party certification

- All plumbing products and materials shall be listed and labeled by third-party certification agency as complying with the referenced standards.

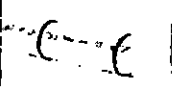

304.4 Openings for Pipes

- IPC removes requirement for metal collars. Adds "shall be sealed with caulking material or gasketing systems compatible with the materials and locations"
- Removes requirement for fastening collars to structure



305.3 and P2603.4 Pipes Through Foundation Walls

- IPC and IRC delete requirements for a relieving arch or a pipe sleeve under a footing
- Breakage section deleted from IPC



312.7 and P2503.5.1 Drainage and Vent Air Test

- IPC and IRC add plastic piping shall not be tested using air



315.1 and P2501.1 Sealing of Annular Spaces

- Was in IPC and IRC sleeve sections. Adds caulking material shall be compatible with the pipe, sleeve, and building materials in contact with the sealing materials





Table 403.1 Minimum Number of Required Fixtures

- Business and mercantile occupancies service sink footnote "g"
- Occupant load of 15 or fewer shall not be required to have a service sink
- Virginia amendment to add footnote "h"



403.1.3 Marina Fixtures

- VUSBC amendment adds: Notwithstanding any provision to the contrary, plumbing fixtures shall be provided for marinas in the minimum number shown in Table 403.1.3





Table 403.1.3 Minimum Number of Required Plumbing Fixtures for Marinas

- Separate facilities are not required where the number of slips is less than 75
- Urinals may be substituted for up to 50% of water closets



403.2 Separate Facilities

- Exception 3
- Separate facilities in mercantile occupancies are not required in which the maximum occupant load is 100 or fewer



403.2.1 Family or Assisted - Use Toilet Serving as Separate Facilities

- New section allows 2 family/assisted-use toilet facilities to serve as separate facilities in a building where separate facilities are required to have one water closet for each sex



403.3 Required Public Toilet Facilities

- Exception: Public facilities are not required in open or enclosed parking garages.
- Toilet facilities are not required in parking garages where there are no attendants



403.1.2 Toilet Room Location

- IPC adds language from Building Code: toilet rooms shall not open directly into a room used for preparation of food service to the public.



403.3.3 Location of Toilet Facilities in Occupancies Other Than Malls

- Adds open so there is no distinction of just covered malls
- VUSBC exception.
- Some exceptions for cemeteries, provided certain conditions are met



403.3.4 Location of Toilet Facilities in Malls

- Adds open so there is no distinction between just covered malls



403.6 Door Locking

- New section adds where a toilet room is provided for the use of multiple occupants, the egress door for the room shall not be lockable from inside the room



403.5 Drinking Fountain Location

- New section
- Drinking fountains shall not be required in individual spaces provided public drinking fountains are located within 500 feet (100 feet in malls) of the most remote location in the tenant space and not more than one story above or below the tenant space. Drinking fountains shall be on an accessible route.

405.3.1 Water Closets, Urinals, Lavatories and Bidets

- Water closet compartments shall not be less than 60 inches in depth for floor-mounted water closets and 56 inches for wall-hung closets.

405.3.2 Public Lavatories

- VUSBC exception: In educational use occupancies, the required lavatory shall be permitted to be located adjacent to the room or space containing the water closet provided that not more than one operational door is between the water closet and the lavatory.

405.2 Automatic Clothes Waste Connection

- The fixture drain for a standpipe for an automatic clothes washer shall connect to a 3" fixture branch or stack.

407.2 and P2713.1 Bathtub Waste Outlets and Overflows

- IPC and IRC add
- Bathtubs shall have an overflow outlet and a water-tight stopper.

410.2 Minimum Number of Drinking Fountains

- IPC adds the requirements from the IRC to require a drinking fountain for wheelchair use and standing persons.

410.3 Drinking Fountains Substitution

- Where restaurants provide drinking water in a container free of charge, drinking fountains shall not be required.

410.4 Prohibited Locations (Drinking Fountains)

- In the IPC water coolers and bottled water dispensers are included with drinking fountains as being prohibited in public restrooms.

415.5 Tempered Water for Public Hand Washing Facilities

- Group wash fixtures are added as needing tempered water.

424.9 and P2722.5 Water Closet Personal Hygiene Devices

- IPC and IRC add new section that requires conformance to the requirements of ASME A112.4.2.

504.7 and P2801.5 Required Pan

- The IPC and IRC clarify that only storage tank type water heaters require a pan.

P2801.6 Water Heaters Installed in Garages

- IRC exception. Elevation of the ignition source is not required for appliances that are listed as flammable vapor ignition-resistant.

605.25 and P2905.19 Polyethylene of Raised Temperature Plastic

- The IPC and IRC add the new material for water service and water distribution piping.

607.1.1 Temperature Limiting Means

- New section prohibits using the thermostat of a water heater serving as the temperature limiting means to comply with the maximum allowable hot or tempered water requirements.

607.2 Hot or Tempered Water Supply to Fixtures

- The hot or tempered water developed length has been reduced from 100 feet to 50 feet where the water supply shall have a recirculating system or heat-traced piping.

15407.5 Pipe Insulation

- The IPC details the International Energy Conservation Code requirements for automatic hot water temperature maintenance systems (circulated loop or heat traced).
- Not less than 1 inch thick pipe insulation.

608.8 and P2901.1 Identification of Non-Potable Water

- Deletes in buildings
- Identification of non-potable water required whether it is inside or outside.

608.11.8 and P2902.3 Spill-Resistant Pressure Vacuum Breakers

- IPC and IRC change from spill proof to spill-resistant and adds CSA B64.1.3 standard.

608.14 Location of Backflow Preventers



- Editorial change to as specified by the manufacturer's instructions not approved manufacturer.



608.16.6 Connections Subject to Back-Pressure

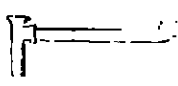

- Adds high hazard as the back pressure that needs protection by a reduced pressure principle backflow preventer assembly.



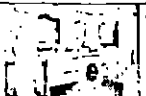

608.16.10 Coffee Machines and Noncarbonated Beverage Dispensers







- In addition to protection by ASSE 1022 or by an air gap, the VUSBC adds ASSE 1024.





<p>706.2 and P3002.3.1 Obstructions</p> <ul style="list-style-type: none"> IPC and IRC add Tubular waste fittings used to convey vertical flow upstream of the trap seal liquid level of a fixture trap shall not be considered an obstruction 	
<p>Table 709.1 Drainage Fixture Units for Fixtures and Groups</p> <ul style="list-style-type: none"> Footnote 1 has in dwelling units deleted Additional fixtures to a bathroom group can have the drainage fixture value unit added to any bathroom group not just dwelling units 	
<p>712.3.4 and P3007.3.3 Sumps and Ejectors Discharge Pipe and Fittings</p> <ul style="list-style-type: none"> The IPC and IRC add the materials suitable for pressurized sewage discharge Brass, Copper, CPVC, Ductile Iron, PE or PVC 	
<p>712.3.3.2 and P3007.3.5 Ratings</p> <ul style="list-style-type: none"> IPC and IRC add Pipe and fittings shall be rated for the maximum system operating pressure and temperature 	
<p>802.1.8 Food Utensils, Dishes, Pots and Pans Sinks</p> <ul style="list-style-type: none"> The IPC deletes directly connected as an option for connecting food preparation sinks in commercial kitchens 	



<p>1001.3.4 Grease Interceptor and Automatic Grease Removal Devices</p> <ul style="list-style-type: none"> The IPC in the exception does not require the PDI or ASME standards for interceptors with a volume not less than 500 gallons and are located outdoors 	
<p>802.2 Installation</p> <ul style="list-style-type: none"> IPC increases from 24" to 30" horizontally or from 4 feet to 54 inches in total developed length the requirement for trapping indirect waste piping. 	
<p>802.2 Installation-Exception</p> <ul style="list-style-type: none"> Waste receptors receiving only clear water waste and not directly connected to a sanitary drainage system, shall not require a trap 	
<p>802.3 and P2706.1 Waste Receptors</p> <ul style="list-style-type: none"> IPC and IRC add plenums, crawl spaces, interstitial spaces above ceilings and below floors as locations where waste receptors shall not be installed 	
<p>P2706.1 Waste Receptors Exception 7</p> <ul style="list-style-type: none"> The IRC adds clothes washer standpipes shall not be permitted in bathrooms 	
<p>901.3 Chemical Waste Vent Systems</p> <ul style="list-style-type: none"> IPC adds shall terminate outdoors or to an air admittance valve that complies with ASSE 1049 tested for chemical resistance in accordance with ASTM F1412 	



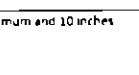

<p>903.5 and P3103.5.1 Location of Vent Terminal</p> <ul style="list-style-type: none"> IPC and IRC change from 2 feet to 3 feet of an opening from other openings unless above the top of such opening 	
<p>915 Combination Waste and Vent System</p> <ul style="list-style-type: none"> Editorial change from Combination Drain and Vent 	
<p>917 Single Stack System</p> <ul style="list-style-type: none"> System where drainage stack and vertical drains are oversized to allow air for venting 	
<p>1003.1 Interceptors and Separators Where Required</p> <ul style="list-style-type: none"> Changes from preventing discharges to the building drainage system to discharges to the public sewer 	
<p>1003.3.1 Grease Interceptors and Automatic Grease Removal Devices Required</p> <ul style="list-style-type: none"> IPC adds one or more grease interceptors shall be permitted to be installed on or above the floor and upstream of an existing grease interceptor 	
<p>1107 Siphonic Roof Drainage Systems</p> <ul style="list-style-type: none"> IPC adds this unconventional roof drainage system 	

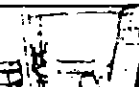
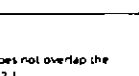
<p>1108 Secondary Roof Drains</p> <ul style="list-style-type: none"> IPC adds Where roof drains are required 	
<p>Chapter 13 Non-Potable Water Systems</p> <p>New chapter separates:</p> <ul style="list-style-type: none"> Gray Water Systems Rainwater Water Systems Reclaimed Water Systems 	
<p>Non-Potable Water Systems</p> <ul style="list-style-type: none"> Water systems for collection, treatment, storage, distribution, and reuse of non-potable water Non-potable systems include reclaimed water, rainwater, and gray water systems. 	
<p>Reclaimed Water Definition</p> <ul style="list-style-type: none"> Water resulting from the treatment of domestic municipal or industrial wastewater that is suitable for a water reuse that is suitable for a water reuse that would otherwise occur. "Gray water" is excluded from definition 	
<p>Rainwater Definition</p> <ul style="list-style-type: none"> Natural precipitation, including snow melt, from roof surfaces only. 	
<p>Gray Water Definition</p> <ul style="list-style-type: none"> Water discharged from lavatories, bathtubs, showers, clothes washers and laundry trays 	

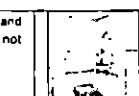
<p>Definition: Non-Potable Fixtures and Outlets</p> <p>Fixtures and outlets that are not dependent on potable water for the safe operation to perform the intended use. Such fixtures and may include, but not limited to:</p> <ul style="list-style-type: none"> Water closets Urinals Irrigation Mechanical equipment Hose connections to perform operations such as vehicle washing and lawn maintenance. 	
<p>Definition: Storm Water</p> <ul style="list-style-type: none"> Precipitation that is discharged across the land surface or through conveyances to one or more waterways and that may include storm water runoff, snow melt, runoff, and surface runoff and drainage. 	
<p>IPC 301.3 Exception</p> <ul style="list-style-type: none"> Bathtubs, showers, lavatories, clothes washers and laundry trays shall not be required to discharge to the sanitary drainage systems where such fixtures discharge to an approved non-potable gray water system in accordance with Chapter 13. 	
<p>IPC 602.2.1 Non-Potable Fixtures and Outlets</p> <ul style="list-style-type: none"> New section Non-potable water shall be permitted to serve non-potable type fixtures and outlets in accordance with Chapter 13. 	
<p>IPC 1101.2 - Exception</p> <ul style="list-style-type: none"> Rainwater non-potable water systems shall be permitted in accordance with Chapter 13. 	
<p>ICC/A117.1-2009 Chapter 6 Plumbing Elements and Facilities Drinking Fountains</p> <ul style="list-style-type: none"> 612.2 exceptions 3 & 4 have been deleted In existing buildings, parallel approaches are not permitted to drinking fountains. 	

<p>ICC/A117.1-2009 Toilet and Bathing Rooms</p> <ul style="list-style-type: none"> 603.2.1 Turning Space adds the required turning space shall not be provided within a toilet compartment. 	
<p>ICC/ANSI - 2009 Swing Up Grab Bars</p> <ul style="list-style-type: none"> 604.5.3 Swing up grab bars are deleted from this section. Swing up grab bars are permitted as required only in Type B units. 	
<p>ICC/A117.1-2009 Urinals</p> <ul style="list-style-type: none"> 605.2 Height and depth adds dimensions for stall type urinals 13 1/2 inches minimum in depth measured from the outer face of the urinal rim to the wall. 	
<p>ICC/A117.1-2009 Bathtubs</p> <p>607.5 Controls.</p> <ul style="list-style-type: none"> Clarifies that the controls shall be between the open side of the bathtub and the centerline of the width of the bathtub 	
<p>ICC/A117.1-2009 Grab Bars at Bathtubs</p> <ul style="list-style-type: none"> Horizontal back wall grab bar can be between 8 inches minimum and 10 inches maximum above the rim of the bathtub This was a specific height of 9 inches in 2003 	

<p>ICC/A117.1-2009 Bathtub Hand Shower</p> <ul style="list-style-type: none"> 617.6 Hand Shower adds where provided the adjustable hand shower mounted on a vertical bar shall be installed so as to not obstruct the use of the Grab Bars. 	
<p>ICC/A117.1-2009 Standard Roll-in Type Shower Seats</p> <p>608.7.2.3 Seat</p> <ul style="list-style-type: none"> A folding seat shall be provided on an end wall Exception. A fixed seat shall be permitted where the seat does not overlap the minimum clear inside dimension required in Section 608.2.2.1 	
<p>ICC/A117.1 Grab Bars in Standard Roll-In Showers</p> <p>608.3.2 Grab bar required on back wall beginning at edge of seat</p> <ul style="list-style-type: none"> No grab bar above seat Back wall grab extends length of wall not required more than 48 inches Opposite side wall of seat if within 72 inches shall extend length of wall but not more than 30 inches 	
<p>ICC/A117.1-2009 Controls & Hand Showers for Standard Roll-In Showers</p> <ul style="list-style-type: none"> 608.4.2 requires the controls and hand shower to be located on the back wall above the grab bar, 45 inches maximum from the floor and 16 inches minimum and 77 inches maximum from the end wall behind the seat 	
<p>ICC/A117.1-2009 Shower Hand Showers</p> <ul style="list-style-type: none"> 605.5 Hand Showers. Adds where provided the adjustable hand shower mounted on a vertical bar shall be installed so as to not obstruct the use of the grab bars 	

<p>ICC/A117.1-2009 Hand Showers Exception to 608.5</p> <ul style="list-style-type: none"> In other than Accessible units and Type A units, a fixed shower head located 48 inches maximum above the shower floor shall be permitted in lieu of a hand shower 	
<p>ENERGY 2012 IECC, 2012 IRC & 2012 USBC</p>	
<p>2012 IECC and 2012 IRC Chapter 11</p> <p>New for 2012</p> <ul style="list-style-type: none"> Residential Energy provisions are located in IRC Chapter 11 and IECC Chapter 4 (IE) Sections in IRC Chapter 11 are subsequently numbered with the corresponding IECC section Commercial Energy provisions are only located in IECC Chapter 4 (CE) 	
<p>IECC C303</p> <ul style="list-style-type: none"> C303.1.3(3) Dynamic Glazing 	
<p>IECC C401</p> <ul style="list-style-type: none"> C401.2 Application 	

D2. HVAC/Mechanical (Classroom and On-line)

You have the option of buying your own books at cost from us or borrow them free of charge during the class. You can also download the material for free if you are taking on-line class.

Course Material – Purchase is optional, or borrow them during the class.

1. 2012 Virginia Mechanical Code (optional)



Book Cost \$75

2. Significant Changes to Mechanical Code 2012 (Optional)

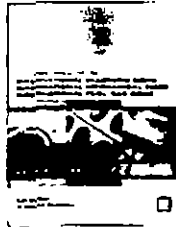

Book Cost \$45





3. 2012 Code Change Summary Guide



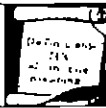
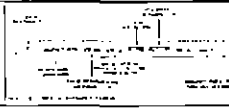

11 page Summarized Code Changes, as attached

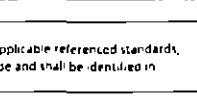

(Available to all students)



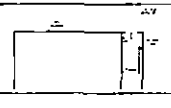

Free

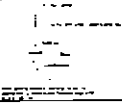
<u>Class Cost</u>	<u>Classroom</u>	<u>Online</u>
Class Cost (include above 15 page Summary)	\$89	\$39
Books (Optional)		
- 2012 Virginia Plumbing Code	\$75	\$75
- Significant Changes to Int'l Plumbing Code 2012	\$45	\$45
Sub Total with Optional books	\$209	\$159

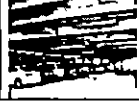
MECHANICAL 2012 IMC & 2012 VCC	
<p>IMC Chapter 2 Definitions</p> <ul style="list-style-type: none"> Environmental Air Press Joint Third Party Certification Agency Third Party Certified Third-Party Tested 	
<p>301.3/M1301.2 Identification</p> <p>Added in 2012</p> <ul style="list-style-type: none"> All pipe, tubing and fittings shall bear the identification of the manufacturer. 	
<p>301.4/M1301.4 Plastic Pipe, Fittings And Components</p> <p>Added in 2012</p> <ul style="list-style-type: none"> Plastic pipe, fittings and components shall be third party certified as conforming to NSF 14. 	
<p>301.5/M1301.5 Third Party Testing And Certification</p> <p>Added in 2012</p> <ul style="list-style-type: none"> Piping, tubing and fittings shall comply with the applicable referenced standards, specifications and performance criteria of this code and shall be identified in accordance with Section 301.3. 	
<p>301.9/M1303.1 Label Information</p> <ul style="list-style-type: none"> Added #4 Electric comfort heating appliances. 	

<p>301.16/M1301.1.1 Flood Hazard</p> <ul style="list-style-type: none"> For structures located in flood hazard areas, mechanical systems, equipment and appliances shall be located at or above the elevation required by Section 1612 of the International Building Code. 	
<p>304.3/M1307.3 Elevation of Ignition Source</p> <ul style="list-style-type: none"> Exception added: Elevation of the ignition source is not required for appliances that are listed as flammable vapor ignition resistant. 	
<p>306.5 Equipment and Appliances on Roofs or Elevated Structures</p> <ul style="list-style-type: none"> 7. Amended: Top rung max 24" below upper edge of the roof hatch, roof or parapet, as applicable 7. Added: Climbing clearance - Min 30" clearance perpendicular to and 15" horizontally from rung midline 	
<p>306.5 Equipment and Appliances on Roofs or Elevated Structures</p> <ul style="list-style-type: none"> 8. Added: 30"x30" clear landing area required 10. Added: Access to ladders shall be provided at all times 	
<p>IRC M1401.2 Access</p> <ul style="list-style-type: none"> Heating and cooling equipment and appliances shall be located with respect to building construction and other equipment and appliances to permit maintenance, servicing and replacement. 	

<p>308.5 Labeled Assemblies</p> <ul style="list-style-type: none"> Added language: "that is listed and labeled in accordance with UL 1618" 	
<p>401.4 Intake Opening Location</p> <p>Added:</p> <ul style="list-style-type: none"> Outdoor air intake openings may be located less than 10 feet horizontally from streets, alleys, parking lots and loading docks if located at least 25 feet vertically above such locations 	
<p>403.3 Outdoor Airflow Rate</p> <ul style="list-style-type: none"> Note revised: Rates per water closet/urinal <ul style="list-style-type: none"> higher rate provided for intermittent exhaust system lower rate permitted only for continuous exhaust system Note revised: Lower rate is permitted only for continuous exhaust system 	
<p>403.3 Outdoor Airflow Rate</p> <p>Note:</p> <ul style="list-style-type: none"> Each mail station must have a source capture system capable of exhausting at least 50 cfm per station 	
<p>404.1 Enclosed Parking Garages</p> <ul style="list-style-type: none"> 2) The system shall be arranged to operate automatically by means of carbon monoxide detectors applied in conjunction with nitrogen detectors... 	

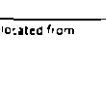
<p>USBC M1401.3 Equipment and Appliance Sizing</p> <ul style="list-style-type: none"> Equipment/appliances shall be sized according to ACCA Manual 5 or by other approved methodologies Exception: Equipment/appliance sizing is not limited to above capacities under certain conditions 	
<p>USBC M1501.2 Transfer Air</p> <ul style="list-style-type: none"> Air transferred from occupiable spaces other than kitchens, baths and toilet rooms may serve as makeup air for exhaust systems 	
<p>USBC M1503.4 Makeup Air Required</p> <p>Exception Added:</p> <ul style="list-style-type: none"> Intentional openings for makeup air are not required for kitchen exhaust systems capable of exhausting not greater than 600 cubic feet per minute (0.28 m³/s) provided that one of the following conditions is met. (See Code Book for details) 	
<p>USBC M1503.4.1 Location</p> <ul style="list-style-type: none"> Kitchen exhaust makeup air shall be provided in the same room as the exhaust system or in a room or duct system communicating through one or more permanent openings with the room in which such exhaust system is located 	
<p>501.2 Independent System Required</p> <ul style="list-style-type: none"> Requirements addressing individual exhaust systems have been relocated from other sections of the IMC and placed here. 	

501.3.2 Exhaust Opening Protection

Added requirement

- Louvers that protect exhaust openings in structures located in hurricane-prone regions shall comply with AMCA Standard 550



504.4 Common Exhaust Systems for Clothes Dryers Located in Multistory Structures

Added #12: Common multistory duct system shall serve only clothes dryers and shall be independent of other exhaust systems



USBC 505.1 Domestic Systems

Amended:

- Where domestic range hoods and domestic appliances equipped with downdraft exhaust are provided, such hoods and appliances shall discharge to the outdoors through sheet metal ducts constructed of galvanized steel, stainless steel, aluminum or copper. Such ducts shall have smooth inner walls, shall be air tight, shall be equipped with a back draft damper, and shall be independent of all other exhaust systems.



USBC 505.1 Domestic Systems

Exception #1 is changed to read: "In Group R buildings, where installed in accordance with the manufacturer's installation instructions and where mechanical or natural ventilation is otherwise provided in accordance with Chapter 4, listed and labeled ductless range hoods shall not be required to discharge to the outdoors."

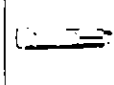

USBC 505.3 Other than Group R

Section added:

- Electric domestic cooking appliances utilized for domestic purposes shall be provided with range hoods
 - Fuel-fired range hood per 507.2

506.3.7.1 Grease Reservoirs

New section provides criteria for construction of a grease reservoir in a grease duct system where the reservoir is not a manufactured product

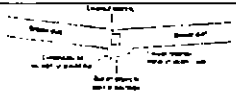

506.3.8 Grease Duct Cleanouts and Other Openings

Section reformatted

Added requirements:

- Cleanout doors to be liquid tight
- Gasket and sealing materials on cleanout doors to be rated minimum 1,500 F°



506.3.9 Grease Duct Horizontal Cleanouts

Section rearranged for ease of use and clarification

Several technical provisions added or modified



506.3.10 Underground Grease Duct Installation

Section has been moved and rearranged with additional requirements



506.3.10 Underground Grease Duct Installation

Updated requirements include:

- Permissible construction materials
- Testing
- Encasement in concrete
- Slope toward reservoirs
- Cleanout requirements



507.2 Where Required

Exception added: Approved cooking appliances equipped with integral downdraft exhaust systems do not require hood above



507.2.1 Type I Hoods

Type I hood not required for electric cooking appliances if cooking process does not produce grease beyond prescribed threshold



507.2.1.2 Exhaust Flow Rate Label

Manufacturers of listed Type I commercial cooking hoods are now required to provide information on a label attached to the hood specifying the listed minimum exhaust air flow for the hood based upon the cooking appliance duty classification

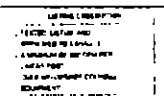

507.2.2 Type II Hoods

Type II hood required above appliances that produce heat or moisture, but not grease or smoke

Exact exhaust rate is specified for areas where a cooking appliance is used but a Type II hood is not required

USBC 507.2.3 Domestic Cooking Appliances Used for Commercial Purposes

Domestic cooking appliances utilized for domestic purposes shall comply with Section 505

507.10 Hoods Penetrating a Ceiling

Field-applied grease duct enclosure systems are now specifically prohibited from being used as enclosures over the top of Type I hoods

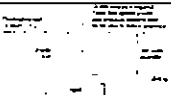

507.11 Grease Filters

Listed and labeled in accordance with UL 1046



510.7 Suppression Required

Added exception #2: Automatic fire suppression systems are no longer required in exhaust ducts in semiconductor fabrication facilities



514 Energy Recovery Ventilation Systems



Section Modified:



- Ducted heat recovery ventilators shall be listed and labeled in accordance with UL 1817
- Non-ducted heat recovery ventilators shall be listed and labeled in accordance with UL 1815

514.4 Recirculated Air

Air conveyed within energy recovery systems shall not be considered as recirculated air where the energy recovery ventilation system is constructed to limit cross leakage between air streams to less than 10 percent of the total airflow design capacity

☐	<p>601.4 Contamination Prevention</p> <ul style="list-style-type: none"> 2nd exception added: Chimneys and vents are now permitted to pass through a plenum under certain conditions Conditions provide means to prevent seepage between flue gas and return air 2.2 The venting system shall be installed such that fittings and joints between sections are not installed in the above ceiling space. 2.3 The venting system shall be installed in a conduit or enclosure with sealed joints separating the interior of the conduit or enclosure from the ceiling.
☐	<p>602.2.1 Materials Within Plenums</p> <ul style="list-style-type: none"> Clarification Any material or assembly that encloses a combustible material in a plenum must be non-combustible, gypsum board, or listed and labeled as part of a tested assembly or system
☐	<p>603.2 Rigid Duct Penetrations</p> <ul style="list-style-type: none"> In relationship to the required garage/dwelling separation, only those ducts that penetrate a wall or ceiling between the dwelling and the adjacent garage need comply with Section 603.7 (Ducts are not required to be 26 gauge when serving only the garage)
☐	<p>603.9/M1601.4.1 Joints, Seams, and Connections</p> <ul style="list-style-type: none"> Unlisted duct tape is no longer permitted as a sealant on any duct 
☐	<p>603.17 Air Dispersion Systems</p> <ul style="list-style-type: none"> Air dispersion systems as defined in Section 202 and recognized in UL 2518 are now permitted to be installed 

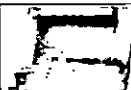
☐	<p>804.3 Mechanical Draft Systems</p> <ul style="list-style-type: none"> Section modified to add "listed and labeled in accordance with UL378"
☐	<p>805.1 Factory Built Chimney Offsets</p> <ul style="list-style-type: none"> The maximum offset in a factory built chimney is now specified and the number of offsets has been limited 
☐	<p>901.4 Fireplace Accessories</p> <ul style="list-style-type: none"> Fireplace accessories must now comply with UL 907 
☐	<p>901.2 Hearth Extensions</p> <ul style="list-style-type: none"> This section has been modified for factory built fireplaces to include "shall comply with UL 1619" 
☐	<p>USBC 908.5 Water Supply</p> <ul style="list-style-type: none"> Cooling towers, evaporative coolers, and fluid coolers shall be provided with an approved water supply and sized for peak demand

☐	<p>927 (New) Radiant Heating Systems</p> <ul style="list-style-type: none"> 927.1 General 927.2 Clearances 927.3 Installation on wood or steel framing 927.4 Installation in concrete or masonry 927.5 Finish surfaces 
☐	<p>928 Evaporative Cooling Equipment</p> <ul style="list-style-type: none"> Requirements for the installation of evaporative coolers have been introduced into the IMC. 
☐	<p>928.1 General. Evaporative cooling equipment shall:</p> <ol style="list-style-type: none"> Be installed in accordance with the manufacturer's instructions Be installed on level platforms in accordance with Section 304.10 Have openings in exterior walls or roofs flashed in accordance with the <i>International Building Code</i>. Be provided with an approved water supply and sized for peak demand. The quality of the water shall be provided in accordance the equipment manufacturer's recommendations. The piping system and protection of the potable water supply shall be installed as required by the <i>IPC (USBC amendment)</i> Have air intake opening locations in accordance with Section 401.4
☐	<p>1105.6.3 Ventilation Rate</p> <ul style="list-style-type: none"> Min. ventilation rates in an ammonia machinery room must now be in accordance with IAR2 

D3. Electrical (Classroom and On-line)

You have the option of buying your own books at cost from us or borrow them free of charge during the class. You can also download the material for free if you are taking on-line class.

Course Material – Purchase is optional, or borrow them during the class.

1. Significant Changes to the NEC 2011 (optional)

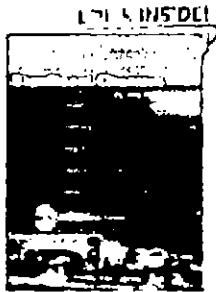

Book Cost \$48

2. 2011 NEC Code Change Summary Guide

14 page Summarized Code Changes, as attached



(Available to all students)





Free





<u>Class Cost</u>	<u>Classroom</u>	<u>Online</u>
Class Cost (include above 15 page Summary)	\$89	\$39
Book (Optional)		
- <u>Significant Changes to the NEC 2011</u>	\$45	\$45
Sub Total with Optional books	\$134	\$84





ELECTRICAL





2011 NEC, 2012 IRC & 2012 VRC





☐	<p>NEC 90.3 Code Arrangement</p> <ul style="list-style-type: none"> Divided into nine chapters Chapters 1-4 apply generally to installations Chapters 5-7 special situations, these chapters modify the general rules of chapters 1-4 Chapter 8 is communication Chapter 9 contains tables 	
☐	<p>NEC 90.5(D) Informational Annex</p> <ul style="list-style-type: none"> Fine Print Notes have been replaced with the term "Informational Annex" Further clarification is made to explain that these are not enforceable 	
☐	<p>NEC 310.16 Arc Flash Hazard Warning</p> <ul style="list-style-type: none"> Requires a field applied identification that an electrical safety hazard exists Required on any switchboard, panelboard, etc that requires disconnection of service Does not apply to dwelling units 	
☐	<p>NEC 110.24 Available Fault Current</p> <ul style="list-style-type: none"> Field applied sticker with the Available Fault Current and the date that the Fault Current was calculated Changes to existing equipment will require an application of a new sticker Does not apply to dwelling units 	
☐	<p>NEC 110.26(A)(3) & IRC E3403.2 Working Clearances</p> <ul style="list-style-type: none"> 2 new exceptions added for locations of electrical equipment Existing dwelling units head clearance Glass meters only extending no more than 6" 	

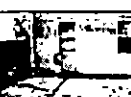
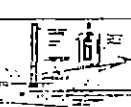

☐	<p>NEC 130.26(D) IRC E405.6 Illumination</p> <ul style="list-style-type: none"> Requires a light at indoor working spaces for service equipment, panels, etc Cannot be controlled by Automatic means only 	
☐	<p>NEC 210.8(A)(7) Sinks</p> <ul style="list-style-type: none"> Clarifies that a receptacle within 6' of the outside edge of any sink shall have GFCI protection. Kitchen sinks are covered in 210.8(A)(6) 	
☐	<p>NEC 210.8(B) 68.7 GFI Protection</p> <ul style="list-style-type: none"> 210.8(B) 16'-Indoor wet locations have been added (such as a carwash) 210.8(B)(7) Locker rooms with associated showering facilities 	
☐	<p>NEC 210.8(B)(8) Garage GFCI Protection</p> <ul style="list-style-type: none"> All garages, service bays and similar area receptacles shall be GFCI Protected This requirement is in addition to the requirements of NEC article 511 	
☐	<p>NEC 210.12(A) and IRC E3902.12 Arc Fault Circuit Interrupters</p> <ul style="list-style-type: none"> Applies to dwellings under 4 stories Also applies to apartments, condos, guest rooms and guest suites that have permanent provisions for locking 	



☐	<p>NEC 210(B) & IRC E3902.12 Arc Fault in Dwelling Units</p> <ul style="list-style-type: none"> USBC amendment deletes expansion for rooms other than bedrooms for 1 and 2 family only 	
☐	<p>NEC 210.52(C)(5) & IRC E3901.4.5 Countertop Receptacles</p> <ul style="list-style-type: none"> Listed receptacle assemblies may be installed in the counter top Gives designers and architects an avenue to achieve code compliance 	
☐	<p>NEC 210.52(E)(3) & IRC E3901.7 Balconies, Decks, and Porches</p> <ul style="list-style-type: none"> Receptacles for all balconies, decks and porches Receptacle shall be located within the Balcony, deck or porch Receptacle placement to be no higher than 6 foot 6 inches 	
☐	<p>NEC 210.52(G) & IRC E1901.3 Accessory Buildings</p> <ul style="list-style-type: none"> Accessory Buildings with power shall require a receptacle This receptacle shall be GFCI protected 	
☐	<p>NEC 210.52(H) & IRC E3901.11 Foyers</p> <ul style="list-style-type: none"> Foyers not part of a hallway Greater than 60 square feet Wall spaces 3 foot or more in width Wall coating rules do not apply to foyers 	

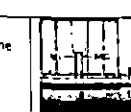

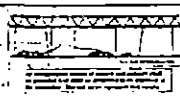
☐	<p>NEC 225.27 & IRC E3803.6 Raceway Seals</p> <ul style="list-style-type: none"> Raceway seals required at outside underground raceways entering a building Sealed with compound like Durt Seal 	
☐	<p>NEC 225.30 Number of Supplies</p> <ul style="list-style-type: none"> Only one branch circuit or feeder shall be allowed to supply power back to the original building Typically applies to emergency power conditions when generator is in a separate building 	
☐	<p>NEC 240.24(E) Overcurrent Devices</p> <ul style="list-style-type: none"> Overcurrent devices shall not be located in dormitory bathrooms 	
☐	<p>NEC 250.2 Definition - Supply Side Bonding Jumper</p>	
☐	<p>NEC 250.30(C) Outdoors Source</p> <ul style="list-style-type: none"> Separately derived systems located outside the building or structure supplied Grounding electrode system shall be tied into the buildings grounding electrode system 	

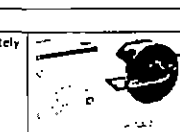

<p>NEC 250.52(A)(2) Building Steel</p> <ul style="list-style-type: none"> Anchor bolts connected to the rebar in the footing by the "usual means" At least 10 foot of structural steel is in direct contact with earth 	
<p>NEC 250.52(A)(1) & IRC E3606.1.7 Concrete Encased Electrode</p> <ul style="list-style-type: none"> Clarification for Concrete Encased Electrode If vapor barrier is installed then the concrete encased electrode is not considered in "direct contact" 	
<p>NEC 250.53(A) & IRC E1608.4 Rod, Pipe Or Plate Electrodes</p> <ul style="list-style-type: none"> Supplemental electrodes now required for Rod, Pipe or Plate electrodes Exception for 75 ohms or less 	
<p>NEC 250.68(C) & IRC E3608.1.1 Bonding Jumper Connections</p> <ul style="list-style-type: none"> New section Clarifies what can be used to make a bonding jumper (bonding steel, rebar, conductor etc.) that connects to the grounding electrode(s) 	
<p>NEC 250.92(B) & IRC E1609.4 Service Bonding</p> <ul style="list-style-type: none"> Bonding jumpers required when concentric, eccentric, reducing washers are used 	

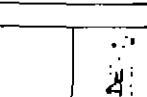
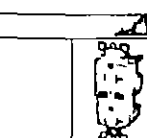

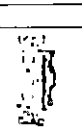

<p>NEC 250.171 & IRC E3610.4 Equipment Grounding Conductors</p> <ul style="list-style-type: none"> Equipment grounding conductor is not allowed to be used as a Grounding Electrode Conductor GEC-1 located between the service point and the service disconnecting means 	
<p>NEC 250.127 & (IRC E3906.1.2) Equipment Grounding Conductors- Tables</p> <ul style="list-style-type: none"> Conductor sizes for 30 and 40 amp circuits have been removed. Follow 60 amp requirements 4000 amp reduced to a 750 kcmil conductor 	
<p>NEC 300.4 E Boxes Installed Under Roof Decking</p> <ul style="list-style-type: none"> Boxes now require 1 1/2" below the lowest level of the roof decking Follows in line with the cable, tubing and conduit rules 	
<p>NEC 300.4 M</p> <ul style="list-style-type: none"> New section for structural joints intended for expansion, deflection or contraction Used in buildings, bridges, parking garages or other structures 	
<p>NEC 300.5 C & IRC E3803.1.1 Raceways Under Buildings</p> <ul style="list-style-type: none"> MC cable and MC cable to be installed under a building Type MC cable shall be the direct burial type and listed for the purpose Type M shall be suitably protected from physical damage 	





<p>NEC 300.11(A)(2) Non-fire Rated Assemblies</p> <ul style="list-style-type: none"> Non fire rated assemblies require supporting methods to be distinguishable Identified by color, tagging or other effective means 	
<p>NEC 310 (Tables) Table Restructuring</p> <ul style="list-style-type: none"> Complete re numbering of all Tables in the NEC An example would be: Table 310.16 is now 310.15 (b) (16) 	
<p>NEC 310.15(B)(3)(a) Adjustment Factors</p> <ul style="list-style-type: none"> "Current Carrying" has been removed from the NEC language IRC remains unchanged Adjustments based on number of conductors in raceway (excluding Ground) and 310.15 (B)(5) and (6) 	
<p>NEC 310 (B) (3)(c) Conductors Above Rooftops</p> <ul style="list-style-type: none"> Circular Raceways replaced the term conduit Table values have been left unchanged 	
<p>NEC 314.27(C) & IRC E3705.8 Ceiling Fan Outlets</p> <ul style="list-style-type: none"> Listed Ceiling Fan box required when a spare separately switched conductor is present in the box 	

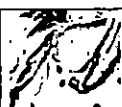



<p>NEC 334.10(1) & IRC E3801.4(1)(a) Type NM Cable in Garages</p> <ul style="list-style-type: none"> Attached and detached garages and storage buildings These cables can be run exposed where not exposed to physical damage Accessory structures such as play houses would still require NM cable to be concealed 	
<p>NEC 338.10(B)(4)(a) & IRC E3705.4.4 Type SE Cable</p> <ul style="list-style-type: none"> Follow 60 Degree column when installed in thermal insulation Derating by maximum cable rating or 60 degree column Defer to 310.15(A)(2) exception for short runs in thermal insulation 	
<p>NEC 404.2(C) & IRC E4001.15 Switches for Lighting Loads</p> <ul style="list-style-type: none"> Switch boxes shall have a neutral conductor in each box Exceptions are unfinished wall on back side of box or box is fed by a raceway 	
<p>NEC 404.9(B) & IRC E4001.11.1 Grounding of Switches</p> <ul style="list-style-type: none"> New exceptions for grounding connection Switch has an integral nonmetallic enclosure Switch is part of a listed non metallic assembly 	
<p>NEC 406.4(D)(4) Replacement Receptacle AFCI</p> <ul style="list-style-type: none"> USBC administrative provisions apply 	



<input type="checkbox"/>	<p>NEC 406.4(D)(5) Receptacle Replacement</p> <ul style="list-style-type: none"> • USBC administrative provisions apply for replacement 	
<input type="checkbox"/>	<p>NEC 404.6(D)(6) Weather Resistant Receptacle</p> <ul style="list-style-type: none"> • Replacement Receptacles installed outdoors will now require the use of a Listed Weather Resistant receptacle • Look for "WR" on the face of receptacle 	
<input type="checkbox"/>	<p>NEC 406.9(B)(1) Wet Location Covers</p> <ul style="list-style-type: none"> • For commercial applications, <u>Grade Supported</u> boxes require in-use covers to be rated "Extra Duty" 	
<input type="checkbox"/>	<p>NEC 406.12 & IRC 4002.14 Tamper Resistant Receptacles</p> <ul style="list-style-type: none"> • Tamper Resistant Receptacles not required in the following areas • Above 5'6" from floor • Receptacles part of a luminaire • Single receptacle for an appliance or duplex for two appliances • For replacement non grounding receptacles 	
<input type="checkbox"/>	<p>NEC 406.14 Guest Room and Suite Receptacles</p> <ul style="list-style-type: none"> • Tamper Resistant Receptacles required 	

<input type="checkbox"/>	<p>NEC 406.14 Child Care Facility</p> <ul style="list-style-type: none"> • Child Care Facilities require Tamper Resistant Receptacles • Child Care Facility Definition • Schools, Churches and Daycare all apply! 	
<input type="checkbox"/>	<p>NEC 408.4(B) Panel Identification</p> <ul style="list-style-type: none"> • Panel boards and switchboards fed with a feeder shall have power source location identified • Not required for one and two family dwelling units • Label affixed to the panel cover! 	
<input type="checkbox"/>	<p>NEC 410.16 & IRC 4007.12 Clothes Closet Luminaires</p> <ul style="list-style-type: none"> • LED lighting may be installed in a closet • LED follows the same spacing rules as incandescent lighting 	
<input type="checkbox"/>	<p>NEC 410.64 Luminaires as a Raceway</p> <ul style="list-style-type: none"> • When used as a raceway, luminaires shall be listed for through-wiring 	
<input type="checkbox"/>	<p>NEC 422.20 & IRC 4101.5 Appliance Disconnecting Means</p> <ul style="list-style-type: none"> • Disconnecting means for appliances shall be grouped and identified 	

<input type="checkbox"/>	<p>NEC 450.14 Transformer Disconnecting Means</p> <ul style="list-style-type: none"> • Transformer disconnecting means shall be within sight of the transformer • Disconnect not within sight of the transformer will be marked for location • Breaker lock permitted 	
<input type="checkbox"/>	<p>NEC 503.10(A)(3) Flexible Wiring Methods</p> <ul style="list-style-type: none"> • <u>Interlocked armor, polymeric coated</u> Type MC cable is permitted in Class III division I locations • Must be installed with dust tight fittings 	
<input type="checkbox"/>	<p>NEC 524.11 Motor Fuel Dispensing Disconnects</p> <ul style="list-style-type: none"> • All power, data, video and communication circuits shall be simultaneously disconnected from their sources of supply 	
<input type="checkbox"/>	<p>NEC 517.13(B) Grounding of Metal Boxes</p> <ul style="list-style-type: none"> • Metal boxes shall be connected to the insulated equipment grounding conductor 	
<input type="checkbox"/>	<p>NEC 517.16 Isolated Ground Receptacles</p> <ul style="list-style-type: none"> • Isolated Ground Receptacles are no longer allowed in Patient Care Areas 	

<input type="checkbox"/>	<p>NEC 517.18 General Care Areas</p> <ul style="list-style-type: none"> • The required circuits shall not be fed from a multiwire branch circuit 	
<input type="checkbox"/>	<p>NEC 517.18(B) Patient Bed Receptacles</p> <ul style="list-style-type: none"> • Quadruplex receptacles Listed Hospital Grade now allowed for Patient Bed locations 	
<input type="checkbox"/>	<p>NEC 525.5(B)(2) Conductor Clearances</p> <ul style="list-style-type: none"> • Portable structures shall not be placed within 15 feet horizontally and vertically of conductors over 600 volts to ground 	
<input type="checkbox"/>	<p>NEC 590.4(D) Temporary Installations</p> <ul style="list-style-type: none"> • Temporary power receptacles installed in a wet location shall be "Extra-Duty" type • Includes 125 and 250 volt receptacles 	
<input type="checkbox"/>	<p>NEC 680.2 Definitions - Low Voltage Contact Limit</p> <ul style="list-style-type: none"> • New definition • A voltage not exceeding the following: <ul style="list-style-type: none"> • 15 volts for sinusoidal ac • 21.7 volts for non sinusoidal ac • 30 volts for continuous dc • 12.4 volts for dc that is interrupted at a rate of 10 to 200 Hz 	

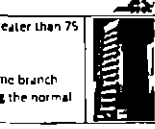
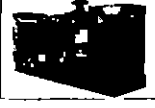
☐	<p>NEC 680.10(Table) Conduit Burial Depths</p> <ul style="list-style-type: none"> • Nonmetallic raceways can be installed 4" deep under concrete slab and can extend 6" from edge of slab • 6" deep if not covered with concrete • Allowed from pool edge to a distance of 5' • Where space limitations apply 	
☐	<p>NEC 680.21(C) GFCI Motor Protection</p> <ul style="list-style-type: none"> • 120 volt through 240 volt outlets supplying pool pump motors must be GFCI protection • Applies to permanent installations 	
☐	<p>NEC 680.26(B)(2) Fixed Metal Part Grounding</p> <ul style="list-style-type: none"> • All fixed metal parts within 5' of pool edge to be bonded 	
☐	<p>NEC 680.43 Ex. #2 Indoor Spas and Hot Tubs</p> <ul style="list-style-type: none"> • New exception for indoor spas and hot tubs on a finished floor • Equipotential bonding not required 	
☐	<p>NEC 680.73 Receptacle Accessibility</p> <ul style="list-style-type: none"> • Receptacle face in direct view of opening and located not farther back than 12" • GFCI protection device required to be readily accessible 	

☐	<p>NEC 694 Small Wind Electric Systems</p> <ul style="list-style-type: none"> • New Article 	
☐	<p>NEC 700.10(D)(3) Emergency Systems</p> <ul style="list-style-type: none"> • Fire rating required to be 2 hour minimum for Buildings greater than 75 ft. or occupancy of 1000 and greater • USBC Amendment - Exception No. 2 Exterior unit equipment permitted to be power by the same branch circuit or powered by the same feeder or service powering the normal exterior lighting 	
☐	<p>NEC 701.6 Legally Required Standby Systems</p> <ul style="list-style-type: none"> • Ground fault indication is now required for legally required standby systems 	
☐	<p>NEC 760.41 NPLFA Power Source</p> <ul style="list-style-type: none"> • NPLFA power source(disconnect) now required to be marked • NPLFA shall be on a dedicated circuit 	

D4. Fuel Gas (Classroom and On-line)

You have the option of buying your own books at cost from us or borrow them free of charge during the class. You can also download the material for free if you are taking on-line class.

Course Material – Purchase is optional, or borrow them during the class.

1. 2012 Virginia Fuel Gas Code (optional)

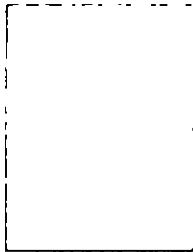

Book Cost \$75

2. Significant Changes to Fuel Gas Code 2012 (Optional)



Book Cost \$45

3. 2012 Code Change Summary Guide

4 page Summarized Code Changes, as attached

(Available to all students)

Free

<u>Class Cost</u>	<u>Classroom</u>	<u>Online</u>
Class Cost (include above 15 page Summary)	\$45	\$29
Books (Optional)		
- 2012 Virginia Plumbing Code	\$75	\$75
- Significant Changes to Int'l Plumbing Code 2012	\$45	\$45
Sub Total with Optional books	\$165	\$149

FUEL GAS
2012 IFGC & 2012 VCC

☐	<p>Chapter 2 Definitions (IFGC & IRC)</p> <ul style="list-style-type: none"> Excessive Flow Valve Flashback Arrestor Check valve Point of Delivery Regulator, Service Pressure Third-Party Certification Agency Third-Party Certified Third-Party Listed
---	--

☐	<p>303.11 Flood Hazard</p> <ul style="list-style-type: none"> Refers to IRC 1612 for location and installation of systems/equipment in buildings in flood hazard areas 	
---	--	---

☐	<p>306.5 Equipment and Appliances on Roofs or Elevated Structures</p> <ul style="list-style-type: none"> Added exception #8 Landing required Added exception #10 Access to ladders shall be provided at all times 	
---	--	---

☐	<p>308.1/G2409.1 Scope</p> <ul style="list-style-type: none"> Gypsum board is considered to be a combustible material regardless of the studs (metal or wood) the board is fastened to 	
---	--	---

☐	<p>309.3.4/G2409.3.4 Clearance from Supply Ducts</p> <ul style="list-style-type: none"> Supply air ducts connecting to listed central heating furnaces shall have the same minimum clearance to combustibles as required for the furnace supply plenum for a distance of not less than 3 feet (914 mm) from the supply plenum. Clearance is not required beyond the 3 foot (914 mm) distance
---	--

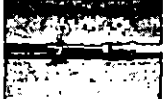
☐	<p>310.1.1/G2411.1.1 CSST</p> <ul style="list-style-type: none"> This change clarifies where the bonding jumper is to connect to the CSST 	
---	---	---

☐	<p>401.8/G2412.9 Identification</p> <ul style="list-style-type: none"> Each length of pipe and tubing and each pipe fitting, utilized in a fuel gas system, shall bear the identification of the manufacturer. 	
---	--	---

☐	<p>401.10/G2412.10 Third-Party Testing and Certification</p> <ul style="list-style-type: none"> All piping, tubing and fittings shall comply with the applicable referenced standards, specs and performance criteria of this code.
---	---

☐	<p>404.1/G2415.1 Installation of Materials</p> <ul style="list-style-type: none"> All materials shall be installed in accordance with the standards under which they were accepted and approved. In the absence of such procedures the manufacturer's installation instructions shall be followed.
---	--

☐	<p>404.7/G2415.2 CSST</p> <ul style="list-style-type: none"> CSST piping systems shall be installed per the terms of their approval, listing conditions, manufacturer's installation instructions and this code. 	
---	--	---

☐	<p>404.18/G2415.18 Prohibited Devices</p> <ul style="list-style-type: none"> A 2nd exception has been added allowing a fitting or device where the system has been sized to accommodate the pressure drop. 	
---	---	---

☐	<p>406.1.6/G2417.1.6 Pipe Clearing</p> <ul style="list-style-type: none"> New section added requiring the clearing of all foreign material prior to testing
---	---

☐	<p>406.7/G2417.7 Purging</p> <ul style="list-style-type: none"> The purging of piping shall be in accordance with Sections 406.7.1 through 406.7.3 of the IFGC. The purging of piping shall be in accordance with Sections G2417.7 through G2417.7.3 of the IRC
---	--

☐	<p>408.4/G2419.4 Sediment Trap</p> <ul style="list-style-type: none"> Text remains the same, however due to misunderstandings as to the construction of a sediment trap an illustration has been added 	
---	--	---

☐	<p>410.4/G2421.4 Excess Flow Valves</p>	
---	--	---

☐	<p>410.5/G2421.5 Flashback Arrestor Check Valve</p> <ul style="list-style-type: none"> Fuel gas systems that are used with oxygen are now required to have a combination flashback arrestor and backflow check valve on both the fuel gas supply and oxygen supply lines 	
---	--	---

☐	<p>503.2.5 Incinerators</p> <ul style="list-style-type: none"> Commercial-industrial type incinerators shall be vented in accordance with NFPA 82-09 	
---	--	---

☐	<p>504.2.9/G2428.2.9</p> <ul style="list-style-type: none"> Adds an additional requirement for a B Vent that exceeds the required height by 5 feet or more above the roof per figures 503.6.4 and G2427.6.3 	
---	---	---

☐	<p>636 Outdoor Decorative Appliances</p> <ul style="list-style-type: none"> Permanently fixed-in-place outdoor decorative appliances must be tested to ANSI Z21.97 and be installed per manufacturer's instructions 	
---	---	---

4. Schedule of Course Dates and Locations

All classroom schedules are announced a month in advance by website and other advertising tools.

All Online courses to be opened without any time limit.

Below as copied our (existing) classroom course announcements;

A. Contractor Pre-license Education

Class Schedule

Date	Time	Class Location
Sep. 12 (Today)	1 pm - 9 pm	Tysons Corner
Sep. 20 (Saturday)	9 am - 5 pm	Tysons Corner
Sep. 30 (Tuesday)	1 pm - 9 pm	Tysons Corner

- Class Fees: Now **\$129** if you register at least one day in advance. **\$139** if paid on the day of first class. Fee includes class materials & License application forms. No PSI materials are used in this class. Please check the Payment Options.
A complete introductory session (w/ Q&A) on *how to take PSI test and license application procedures* is included.

B. Continuing Education

For both Journeyman and Master Tradesmen.
All classes are held at Tysons location only.

[4th week of September]

Trade CE	Class date	Time	Cost
ELE 3-hr CE	23rd (Tues.),	3-6 pm	\$89 (w/ class mat'l)
	or 26th (Fri.)	3-6 pm	

Plumbing 3-hr CE	22nd (Mon.),	6-9 pm	\$89 (w/ class mat'l)
	or 24th (Wed.)	6-9 pm	
HVAC 3-hr CE	22nd (Mon.),	3-6 pm	\$89 (w/ class mat'l)
	or 24th (Wed.)	3-6 pm	
Gas Fitting 1-hr CE	22nd (Mon.),	9-10 pm	\$45 (w/ class mat'l)
	or 24th (Wed.)	9-10 pm	

[5th week of September]

Trade CE	Class date	Time	Cost
ELE 3-hr CE	30th (Tues.)	3-6 pm	\$89 (w/ class mat'l)
Plumbing 3-hr CE	29th (Mon.)	6-9 pm	\$89 (w/ class mat'l)
HVAC 3-hr CE	29th (Mon.)	3-6 pm	\$89 (w/ class mat'l)
Gas Fitting 1-hr CE	29th (Mon.)	9-10 pm	\$45 (w/ class mat'l)

COPY

CERTIFICATE OF MERIT

has completed an 8 Hour VA Pre-Licensing Requirement Class
To Review Contractor Business concerns including
Virginia Regulation of Contractors, Estimating & Bidding, Contracts,
Project Management, Risk & Safety, Labor & Tax Law and Financial Management

THEREBY demonstrating a commitment to organization growth
and personal development

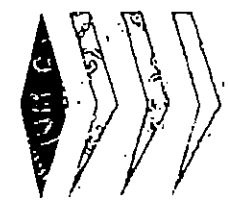

Ace Tech (Millennium) Institute
Tysons Corner, Virginia
Provider # 2730000056 Course # 2731001258

Ace Tech

Instructor

Jne 5, 2014
Class Dates

CERTIFICATE OF MERIT

COPY

4500 2014 1261

has completed the 3 Hour review of International Plumbing Code (IPC) to satisfy the continuing education course requirements for Plumbing Journeyman or Master Tradesman license by the Commonwealth of Virginia, DPOR.

THEREBY demonstrating a commitment to organization growth and personal development

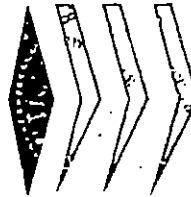

Ace Tech Institute
since 1999



Ace Tech (Millennium) Institute
Tysons Corner, Virginia

Provider # 2730000056

Course # 2731001261

Instructor _____

May 20, 2014

Class Dates

CERTIFICATE OF MERIT

COPIED

Complete Summary

has completed an 3 Hour review of International Mechanical Code (IMC) to complete a continuing educational course for holding HVAC journeyman or master tradesman license required in the Commonwealth of Virginia, DPOR Requirements.

THEREBY demonstrating a commitment to organization growth and personal development

*Ace Tech (Millennium) Institute
Tysons Corner, Virginia*

Provider # 2730000056 Course # 2731001958

**Ace Tech
Institute**
since 1999

Instructor

May 20, 2014

Class Dates

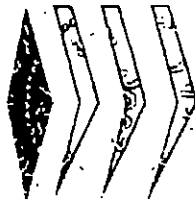

CERTIFICATE OF MERIT

COPY

has completed an 3 Hour review of National Electrical Code (NEC)
to complete a continuing educational course

for holding Electrical journeyman or master tradesman license
required in the Commonwealth of Virginia, DPOR Requirements.

THEREBY demonstrating a commitment to organization growth
and personal development

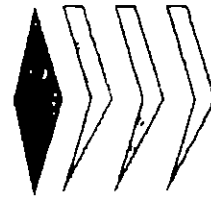

Ace Tech

Ace Tech (Millennium) Institute
Tysons Corner, Virginia

Provider # 2730000056

Course # 2731001260

Instructor _____

June 24, 2014

Class Dates



CERTIFICATE OF MERIT

COPY

Kimmy

has completed an 1 Hour review of International Gas-Fuel Code (IGFC) to complete a continuing educational course for holding Gas-Fitting journeyman or master tradesman license required in the Commonwealth of Virginia, DPOR Requirements.

THEREBY demonstrating a commitment to organization growth and personal development



Ace Tech (Millennium) Institute
Tysons Corner, Virginia

Provider # 2730000056 Course # 2731001959

Ace Tech Institute

April 21, 2014

1987-1990

6. Online Course Information

Total 5 Online Courses: A. Contractor Pre-License Education
B. Continuing Education (PLB, HVAC, ELE and Gas)

A. Security Measures

At Ace Tech Institute website, www.contractVA.com, safeguarding your online security and privacy is a high priority. We use strict controls to ensure that your online communications and transactions are as safe and reliable.

We use the following measures to insure safety

- Your access to courses are protected by Username and Passwords so you can only access your account

- We use Secure Sockets Layer/Transport Layer Security (SSL/TLS) technology to establish an encrypted connection between your browser and our Web applications. SSL/TLS websites start with "https://" instead of "http://" and signify that you are in a secure online session with us. To ensure your protection, we require 128-bit encryption (the current industry standard) and a modern version of the SSL/TLS protocol - these are supported by current versions of all modern browsers.

- Notifications and Confirmations mails are promptly sent by our servers to keep you updates with latest activity

- We store your personal details on highly secured server hence protecting it from any kind of threats.

- We keep updating and maintaining our servers and website to ensure maximum security

It is advised to keep your login credentials safe.

B. How to Login and take Courses Walkthrough

If you want to test the courses and login use the credentials given below

Username – testuser

Password - mtech182.182

Our Ace Tech Website as;

www.contractVA.com

Go to Students > My Account to Login to See your courses

The screenshot shows the website interface for Ace Tech Institute. At the top, there is a navigation bar with the following text: "Website Under Revision | Call us at: 703-298-5789 or 703-298-4356 or email us at: admin@contractva.com". To the right of this bar, it says "ContractVA Website" and "Open Hours: Monday-Friday 2:00 PM - 9:00 PM, Saturday 9:00 AM - 1:00 PM". Below the navigation bar, there are links for "Home", "About Us", "Our Courses", "Student", "Contact Us", "FAQ", and "Links". The main content area is divided into two columns. The left column is titled "My Courses" and contains a "Login" section with fields for "Username" and "Password", a "Login" button, and a "Remember me" checkbox. The right column is titled "EDUCATION" and contains a "Register" section with fields for "Username *", "Email address *", and "Password *", along with a "Register" button. A "Contact us" link is visible in the bottom right corner of the page.

Put in your username and password like showed below

Ace Tech Institute – My Courses

Login

Enter Username

Username

Password

[Lost your password?](#)

Remember me

Enter password to login

After Logging in you will see all the courses you have purchased
(Courses will not show until the payment has been made and confirmed)

My Messages

Login> This is the my course page

Active Courses Completed Courses

VA Prelicensing - 8 Hrs
by admin 3 Lessons in On-Line 1 Lessons completed

MFP Continuing Education (CE) - Plumbing (3 hr)
by admin 3 Lessons in On-Line 0 Lessons completed

You can see the active Courses here
(the courses will not show until its been paid and confirmed)

Click on the Course to view the info and lessons

This is the lessons page for selected course
It will consist of all the lessons associated with the course

Course Media

• Licensing application form to state of VA

Login>my - Courses> Selected Course

Lessons

Currently completed 0 of 3 in total



VA Pre-Licensing Lesson # 1

Author admin



List of lessons the course consist
Click to take the lesson

VA Pre-Licensing Lesson # 2

Author admin

VA Pre-Licensing Lesson # 3

Author admin

Contact us

Below every lesson there will be typically a quiz

Click here to view lessons quiz

Below every lesson there be quiz typically



 You require 70% to pass this lesson's quiz.



This is the quiz page, you need to choose the correct answer

(Require 70% to pass the quiz)

When you are done answering all the questions click the button to complete the quiz or save it for later

After you complete the quiz you will be showed with you score and result

Ace Tech Institute since 1999
 Monday-Friday: 2:00 PM - 9:00 PM
 Saturday: 9:00 AM - 1:00 PM

[Home](#) [About Us](#) [Our Courses](#) [Student](#) [Contact Us](#) [FAQ](#) [Links](#)

CE-Electrical Lesson # 2 Quiz EDUCATION

CE-Electrical Lesson # 2 Quiz

✓ Congratulations! You have passed this quiz at 100%

1. Bonding jumper(s) shall be sized in accordance with Table 350.66 (10)
 True
 False Grade 10

2. If a single rod, pipe, or plate grounding electrode has a resistance to earth, the highest ohms it can be at for a supplemental electrode not being required is 25 (10)
 True
 False Grade 10

[Contact us](#)

Once you complete all the lessons and take all the quiz, the course will be moved to the completed course tab where you can view your certificates and results

Website Under Renovation | Call us at: 703-298-5789 or 703-298-4556 or email us at: admin@contractsv.com [Contact Us via Website](#)

Ace Tech Institute since 1999
 Open Hours
 Monday-Friday: 2:00 PM - 9:00 PM
 Saturday: 9:00 AM - 1:00 PM

[Home](#) [About Us](#) [Our Courses](#) [Student](#) [Contact Us](#) [FAQ](#) [Links](#)

My Courses EDUCATION

My Messages

Active Courses Completed Courses

CE-Electrical (3 hr)
 by admin | 3/15/2015 | On-Line

Click to view certificates you have received view your results

This is the checkout page for ordering your courses

Checkout

EDUCATION



This is the checkout page

⊙ Hello,
testuser

Need Assistance? Call customer service at 703-298-5789, 703-298-4556 or
email us at

admin@contractva.com

[VIEW
CART](#)

Have A *Promotional Code*?

Coupon Code

[APPLY COUPON](#)

1. [View order](#)

2. [Shipping & Billing](#)

3. [Billing](#)

4. [Payment](#)

Please let us know if you have any problem;

Email us – contactUS@contractVA.com

Call us – (703) 298-2685/4556/5789

All topics are related on employment in construction industry, from entry to intermediate level.

TRAINING

Electrical, HVAC & Plumbing

* 240 Hours (Maximum) - The hours are recognized by state of VA.

GOAL

- To pass Journeyman exam in Electrical
- To pass Journeyman exam in HVAC
- To pass Journeyman exam in Plumbing

24-48 weeks

Class Details

- Learning required regulations & Codes.
- Field training (OJT) as needed for practices.
- Journeyman exam prep class to pass PSI exam.

*Class Costs: \$3,600 (Including all text material)

*Excluded: PSI exam fees - VA (\$100), MD (\$50) and License Application fees

Ace Tech Millennium

4 Class Locations

Class hours - afternoon (1-5 pm), evening (5:30-9:30 pm), and Sat.

Tyson

7777 Leesburg Pike Suite 205s

Falls Church, VA 22043

Silver Spring

1751 Elton Rd. Suite 201

Silver Spring, MD 20903

Woodbridge

1388 Old Bridge Rd. Suite 201

Woodbridge, VA 22192

Chantilly

Open Soon



Ace Tech
Institute
Since 1999



www.contractVA.com
(703) 298-5789 / 288-3288



Llamenos al
202-870-6640
entre las 10 am - 4pm

All topics are related on employment in construction industry, from entry to intermediate level

BUILDING CONSTRUCTION TECHNICAL TRAINING

* 100 Hours (Average)

GOAL

- Passing the contractor licensing exam to qualify in VA & MD
- Learning the basic construction industry trades and skills
- Comprehension of many safety and federal/local regulations understanding

8-12 weeks

Class Details

- | | |
|---------------------------------|----------|
| a. Building construction basic | 24 hours |
| b. Building Codes (IRC) | 16 hours |
| c. Contractor topic study | 24 hours |
| d. EPA Lead RRP certification | 8 hours |
| e. Contractor licensing courses | 28 hours |

*Class Costs: \$1,995 (Including all text material)

*Excluded: PSI exam fees - VA (\$170), MD (\$54) and License Application fees

Ace Tech Millennium

4 Class Locations

Class hours - afternoon (1-5 pm), evening (5:30-9:30 pm), and Sat.

Tyson

7777 Leesburg Pike Suite 205s

Falls Church, VA 22043

Silver Spring

1751 Elton Rd. Suite 201

Silver Spring, MD 20903

Woodbridge

1388 Old Bridge Rd. Suite 201

Woodbridge, VA 22192

Chantilly

Open Soon

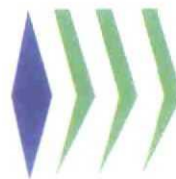

Ace Tech
Institute
Since 1999

www.contractVA.com
(703) 298-5789 / 288-3288

Llamos al
202-870-6640
entre las 10 am - 4pm

APPLICATION REVIEW SUMMARY

October 21, 2014

PROVIDER NAME:	RedVector.com LLC																		
TYPE OF COURSE:	Continuing Education																		
SUBJECT(S):	Electrical																		
METHOD OF INSTRUCTION:	Online																		
PREVIOUS BOARD APPROVAL(S):																			
STAFF RECOMMENDATION:	APPROVAL OF THE FOLLOWING COURSE(S) <table><thead><tr><th>COURSE NAME</th><th>HOURS</th></tr></thead><tbody><tr><td>2011 NEC Code Update – Ch. 3</td><td>3.0</td></tr><tr><td>2011 NEC Code Update – Ch. 4</td><td>3.0</td></tr><tr><td>2011 NEC Code Update – Ch. 5</td><td>3.0</td></tr><tr><td>2011 NEC Code Update Intro- Ch. 1 & 2</td><td>3.0</td></tr><tr><td>2014 NEC Changes Intro – Ch.1 & 2</td><td>3.0</td></tr><tr><td>2014 NEC Changes – Ch. 3 & 4</td><td>3.0</td></tr><tr><td>2014 NEC Changes – Ch. 5 & 6</td><td>3.0</td></tr><tr><td>2014 NEC Changes – Ch. 7 & 8</td><td>3.0</td></tr></tbody></table>	COURSE NAME	HOURS	2011 NEC Code Update – Ch. 3	3.0	2011 NEC Code Update – Ch. 4	3.0	2011 NEC Code Update – Ch. 5	3.0	2011 NEC Code Update Intro- Ch. 1 & 2	3.0	2014 NEC Changes Intro – Ch.1 & 2	3.0	2014 NEC Changes – Ch. 3 & 4	3.0	2014 NEC Changes – Ch. 5 & 6	3.0	2014 NEC Changes – Ch. 7 & 8	3.0
COURSE NAME	HOURS																		
2011 NEC Code Update – Ch. 3	3.0																		
2011 NEC Code Update – Ch. 4	3.0																		
2011 NEC Code Update – Ch. 5	3.0																		
2011 NEC Code Update Intro- Ch. 1 & 2	3.0																		
2014 NEC Changes Intro – Ch.1 & 2	3.0																		
2014 NEC Changes – Ch. 3 & 4	3.0																		
2014 NEC Changes – Ch. 5 & 6	3.0																		
2014 NEC Changes – Ch. 7 & 8	3.0																		

EDUCATION APPLICATION CHECKLIST

Staff Recommendation: Approve Non-approval
 ED Provisional Approval Y N Date: _____
 Committee Approval Y N Date: _____
 Board Approval Y N Date: _____

Provider Name & # **RedVector.com LLC**
 Number (last 6 Digits): _____

Review Date: **October 6, 2014**

Initial Provider Approval Amendment to Existing Course Approval

Contact Name: **Ellen Sakamoto**

Contact Number: _____

Email: _____

Type of Course and Subject:

CE	Voc.		Online	Class	Other
		Tradesman & Individual Certification			
<input type="checkbox"/>	<input type="checkbox"/>	Plumbing	<input type="checkbox"/>	<input type="checkbox"/>	<input type="checkbox"/>
<input checked="" type="checkbox"/>	<input type="checkbox"/>	Electrical	<input checked="" type="checkbox"/>	<input type="checkbox"/>	<input type="checkbox"/>
<input type="checkbox"/>	<input type="checkbox"/>	HVAC	<input type="checkbox"/>	<input type="checkbox"/>	<input type="checkbox"/>
<input type="checkbox"/>	<input type="checkbox"/>	Gas Fitter	<input type="checkbox"/>	<input type="checkbox"/>	<input type="checkbox"/>
<input type="checkbox"/>	<input type="checkbox"/>	LP Gas Fitter	<input type="checkbox"/>	<input type="checkbox"/>	<input type="checkbox"/>
<input type="checkbox"/>	<input type="checkbox"/>	NG Fitter Provider	<input type="checkbox"/>	<input type="checkbox"/>	<input type="checkbox"/>
<input type="checkbox"/>	<input type="checkbox"/>	Certified Elevator Mechanic	<input type="checkbox"/>	<input type="checkbox"/>	<input type="checkbox"/>
<input type="checkbox"/>	<input type="checkbox"/>	Certified Water Well Providers	<input type="checkbox"/>	<input type="checkbox"/>	<input type="checkbox"/>
<input type="checkbox"/>	<input type="checkbox"/>	Certified Backflow Prevention Device Worker	<input type="checkbox"/>	<input type="checkbox"/>	<input type="checkbox"/>
<input type="checkbox"/>		Contractor Pre-License	<input type="checkbox"/>	<input type="checkbox"/>	<input type="checkbox"/>
		Contractor Remedial			
<input type="checkbox"/>	<input type="checkbox"/>	Remedial Education – Basic	<input type="checkbox"/>	<input type="checkbox"/>	<input type="checkbox"/>
<input type="checkbox"/>	<input type="checkbox"/>	Remedial Education – Advanced	<input type="checkbox"/>	<input type="checkbox"/>	<input type="checkbox"/>

Course Information

Course Name	Contact Hours	Credit Hours	Trades Only	
			Subject	Course Type
2011 NEC Code Update - Ch. 3	3	3	ELE	CE
2011 NEC Code Update - Ch. 4	3	3	ELE	CE
2011 NEC Code Update - Ch. 5	3	3	ELE	CE
2011 NEC Code Update Intro- Ch.1 & 2	3	3	ELE	CE
2014 NEC Changes Intro - Ch. 1 & 2	3	3	ELE	CE
2014 NEC Changes Ch. 3 & 4	3	3	ELE	CE
2014 NEC Changes Ch. 5 & 6	3	3	ELE	CE
2014 NEC Changes Ch. 7 & 8	3	3	ELE	CE

Documentation:

<input checked="" type="checkbox"/>	Course Syllabus
<input checked="" type="checkbox"/>	Outline of Courses
<input type="checkbox"/> Yes <input checked="" type="checkbox"/> No	Time Allocations per Topic Provided?
<input checked="" type="checkbox"/>	Fees Yes
<input checked="" type="checkbox"/>	Materials Listing Yes
<input checked="" type="checkbox"/> Yes <input type="checkbox"/> No	Handbook/Slides/Information Provided? Powerpoint Presentation
<input checked="" type="checkbox"/>	Schedule of Course Dates
<input checked="" type="checkbox"/>	Schedule of Locations

CONTRACTOR PRELICENSE/REMEDIAL

Board Regulations Covered

TRADESMAN CE

Code Updates Covered

Comments:

Online Courses Only

- Demonstration/Web Access Provided
- Security Policy Covered
- Briefly explain:
- Quiz/Test

List of Instructors

	Name	VA Lic. No.	Education Experience	Resume?
	Joe Crump		<input checked="" type="checkbox"/>	<input checked="" type="checkbox"/>
	Neal Burdick		<input checked="" type="checkbox"/>	<input checked="" type="checkbox"/>
			<input type="checkbox"/>	<input type="checkbox"/>
			<input type="checkbox"/>	<input type="checkbox"/>
			<input type="checkbox"/>	<input type="checkbox"/>
			<input type="checkbox"/>	<input type="checkbox"/>

Record of Correspondence:

Letter Sent (i.e., Al ltr, mg ltr, approval ltr)

Date:



Board for Contractors
EDUCATION PROVIDER REGISTRATION/COURSE APPROVAL APPLICATION
No Fee Required

Select the action(s) you are requesting.

X	Registration Type:
<input checked="" type="checkbox"/>	Initial Provider Registration & Course Approval
<input type="checkbox"/>	Course Approval Application

1. Name of Provider RedVector.com, LLC
2. VA Contractor's Education Provider Registration Number (if applicable)

2	7								
---	---	--	--	--	--	--	--	--	--
3. Mailing Address (PO Box accepted) 4890 West Kennedy Blvd., Ste. 740
 If a mailing address is submitted, the mailing address will be printed on the license.

<u>Tampa</u>	<u>FL</u>	<u>33609</u>
City	State	Zip Code
4. Street Address (PO Box not accepted) Check here if Street Address is the same as the Mailing Address listed above.
PHYSICAL ADDRESS REQUIRED
4890 West Kennedy Blvd., Ste. 740

<u>Tampa</u>	<u>FL</u>	<u>33609</u>
City	State	Zip Code
5. Email Address Ellen.Sakamoto@RedVector.com
 (Email address are used for electronic communication from the Board. Owner/manager e-mail address are acceptable)
6. Web Address http://www.RedVector.com
7. Contact Numbers

<u>(813) 425-7372</u>	<u>(941) 827-8973</u>
Primary Telephone	Alternate Telephone
8. Type of School/Provider (select only one)
 Privately owned school/provider
 Professional/Trade association
 Other _____
9. School Owner(s): Enter the name of the proprietor partnership, association, limited liability company, or corporation.
RedVector.com, LLC
10. Name and Title of Contact Person Ellen Sakamoto, Director of Accreditations
11. Contact Person's Telephone Numbers

<u>(813) 425-7372</u>
Primary Telephone

12. Type of course to be offered (select all that apply)

- A. Contractor Pre-License Education
- B. Remedial Education
- C. Individual Vocational Training - (select all that apply)
 - Plumbing
 - Electrical
 - HVAC
 - Gas Fitter
 - Liquefied Petroleum Gas Fitter
 - Natural Gas Fitter Provider
 - Certified Elevator Mechanic
 - Certified Water Well Systems Provider
 - Certified Accessibility Mechanic
 - Certified Backflow Device Prevention Device Worker
- D. Continuing Education - (select all that apply)
 - Plumbing
 - HVAC/ Mechanical
 - Electrical
 - Gas Fitter
 - Certified Elevator Mechanic
 - Certified Water Well Systems Providers
 - Liquefied Petroleum Gas Fitter
 - Natural Gas Fitter Provider
 - Certified Accessibility Mechanic

13. Method of Instruction (select all that apply)

- Classroom
- Correspondence
- On-line
- Other distance learning, please describe

14. Course Information

Course Name	Course Hours	Subject (From items listed in #12; provide for each course listed)	OFFICE USE ONLY (COURSE NO.)	(Credit Hours)
Series B: 2011 NEC Code Changes - Chapter 3	3	Continuing Education - Electrical		
Series B: 2011 NEC Code Changes - Chapter 4	3	Continuing Education - Electrical		
Series B: 2011 NEC Code Changes - Chapter 5	3	Continuing Education - Electrical		
Series B: 2011 NEC Code Changes - Intro, Ch 1 & Ch 2	3	Continuing Education - Electrical		
2014 NEC Changes - Introduction, Ch. 1 and Ch. 2	3	Continuing Education - Electrical		
2014 NEC Changes - Chapters 3 and 4	3	Continuing Education - Electrical		
2014 NEC Changes - Chapter 5 and 6	3	Continuing Education - Electrical		
2014 NEC Changes - Chapters 7 and 8	3	Continuing Education - Electrical		

15. Instructor Information. Attach a resume for each instructor listed below.

Instructor's Name	Title	Phone Number
Joe Crump - 2011 NEC Courses		
Neal Burdick - 2014 NEC Courses		

16. I, the undersigned, certify that the foregoing statements and answers are true, and I have not suppressed any information that might affect the Board's decision to approve this application. I certify that the provider has complied with all the laws of Virginia related to the education requirements under the provisions of Title 54.1, Chapter 11 of the *Code of Virginia, the Board for Contractors Regulations, and the Board for Contractors Individual Licensing and Certification Regulations.*

Responsible Manager (RM)

Print Name Ellen Sakamoto

Date 06/11/2014

Signature



REQUIRED ATTACHMENTS FOR EACH COURSE

The following attachments must be provided for each course. Please include a spacer page to label each attachment according to the numbers listed below.

- **Attachment # 1: Course Syllabus** - The course syllabus lists the purpose of the course and the main topics covered in the course. This includes any specific code sections to be discussed in the continuing education course. Vocational training courses should include a detailed curriculum for the training program. Backflow prevention device worker vocational training programs must include instruction in a wet lab as part of the syllabus.
- **Attachment # 2: Instructor Information** - List all instructors for the course with applicable Virginia Tradesman, Individual Certification, or Contractor license numbers (if available). In addition, a one-page resume with appropriate teaching and technical experience must be included for each instructor.
- **Attachment # 3: Course Materials and Fees** - Information pertaining to any materials used or distributed during the course, including books, handouts, pamphlets, and slide presentations/overheads. If the materials are "custom" information, i.e. developed by the provider, please provide a copy. If you will be using materials developed by an outside source, please provide detailed information about the publication. A copy of the materials may be requested. Please provide the fees that will be assessed for the course and whether or not the fees include any materials for the course and, if not, the materials that students are required to furnish.
- **Attachment # 4: Schedule of Course Dates and Locations** - Provide information pertaining to the anticipated schedule and location(s) for the course. If you have not developed a schedule, please provide an anticipated start date for the program. Please note that you must provide the Board office with a final schedule and location(s) prior to holding the class.
- **Attachment # 5: Course Completion Certificate** - If students will be provided with a certificate of completion at the end of the course, please provide a copy marked "sample."
- **Attachment # 6: Online/Correspondence Course Information** - If an online or correspondence course, please provide information on the security procedures to be utilized. In addition, provide information on the test that will be given at the end of the course and security related to the test. Online providers must provide the website address, user ID, and password to be utilized by the Board during the review process in order to access your course. Correspondence course providers must provide a copy of the packet that will be distributed to students.



September 5, 2014

Commonwealth of Virginia
Department of Professional and Occupational Regulation
9960 Maryland Drive, Suite 400
Richmond, VA 23233-1485
804-367-8511

RECEIVED
SEP 9 2014
CONTRACTORS

Re: Education Provider Registration/Course Approval Application

Dear Sir or Madam:

Enclosed you will find the corresponding course lessons for the 8 courses submitted for continuing education approval in the State of Virginia.

	Title	CE Hours
1	Series B: 2011 NEC Code Changes - Chapter 3 (RV-10287)	3
2	Series B: 2011 NEC Code Changes - Chapter 4 (RV-10288)	3
3	Series B: 2011 NEC Code Changes - Chapter 5 (RV-10289)	3
4	Series B: 2011 NEC Code Changes - Introduction, Chapter 1 & Chapter 2 (RV-10286)	3
5	2014 NEC Changes – Introduction, Chapter 1 and Chapter 2 (RV-PGM101)	3
6	2014 NEC Changes - Chapter 3 and Chapter 4 (RV-PGM102)	3
7	2014 NEC Changes - Chapter 5 and Chapter 6 (RV-PGM103)	3
8	2014 NEC Changes - Chapter 7 and Chapter 8 (RV-PGM106)	3

The Board has been set up with a test account to preview courses on the RedVector.com website. To access the courses, please follow the directions below.

1. Log on to the web site at <http://www.RedVector.com>
2. On the top center of the page click the orange "Sign-In" button.
3. In the gray column labeled "Returning Users" enter your username **VAELEC** and your password **vaelec (both are case-sensitive)**. Click the "LOGIN" button.
4. You should arrive at the User Menu. Click on the second box "My Courses".
5. A list of courses will appear. Click on the title of the course you wish to begin and follow the instructions.

I apologize for not including this together with the applications. If you require any additional information, please feel free to contact me. Thank you for your time and consideration.

Sincerely,



Ellen Sakamoto
Director of Accreditation



1-813-425-7372 Direct Line

1-941-827-8973 Fax

Ellen.Sakamoto@RedVector.com

Attachment #1: Course Syllabus

Course Title:

Series B: 2011 NEC Code Changes - Chapter 3 (RV-10287)

Course Hours:

3 hours

Course Instructor:

Joe Crump

Course Description:

The NFPA® updates to the NEC Code periodically – you need to know the latest updates and the reasons for them.

This **interactive online** course provides you with everything you need to be familiar with the NEC Code – specifically the 2011 version. For all of the major Code changes covered, you'll get:

- A summary addressing each relevant Change.
- Excerpts of actual 2011 National Electrical Code® text with relevant Staff comments and illustrations.
- First-time articles, usability improvements, and revisions that boost electrical safety making the 2011 National Electrical Code® essential.

Course Objectives:

At the conclusion of this course, you will be able to:

- Identify the various significant changes in Chapter 3 of the NEC
- Recognize the reasons for changes to existing Code
- List new articles in the Code
- Describe deletions in some existing requirements

Course Outline:

Introduction

Ch. 3 Articles 300.3-300.50

- Article 300 — Wiring Methods
- 300.3 Conductors
- 300.4 Protection Against Physical Damage
- 300.5 Underground Installations
- 300.6 Protection Against Corrosion and Deterioration
- 300.7 Raceways Exposed to Different Temperatures
- 300.10 Electrical Continuity of Metal Raceways and Enclosures
- 300.11 Securing and Supporting
- 300.19 Supporting Conductors in Vertical Raceways
- 300.22 Wiring in Ducts Not Used for Air Handling, Fabricated Ducts for Environmental Air, and Other Spaces for Environmental Air (Plenums)
- 300.37 Aboveground Wiring Methods
- 300.50 Underground Installations

Ch. 3 Articles 310.2-310.104

- Article 310 — Conductors for General Wiring

- 310.2 Definitions
- 310.10 Uses Permitted
- 310.15 Ampacities for Conductors Rated 0–2000 Volts
- 310.60 Conductors Rated 2001 to 35,000 Volts
- 310.104 Conductor Constructions and Applications

Ch. 3 Articles 312.8-314.72

- 312.8 Switch and Overcurrent Device Enclosures with Splices, Taps, and Feed-Through Conductors
- 312.10 Material
- 314.21 Repairing Noncombustible Surfaces
- 314.23 Supports
- 314.24 Depth of Boxes
- 314.27 Outlet Boxes
- 314.28 Pull and Junction Boxes and Conduit Bodies
- 314.30 Handhole Enclosures
- 314.70 General
- 314.72 Construction and Installation Requirements

Ch. 3 Articles 320.2-338.10

- Article 320 — Armored Cable: Type AC
- 320.2 Definition
- 320.23 In Accessible Attics
- 320.80 Ampacity
- 322.12 Uses Not Permitted
- 328.10 Uses Permitted
- 328.14 Installation
- 330.10 Uses Permitted
- 334.15 Exposed Work
- 334.80 Ampacity
- 336.12 Uses Not Permitted
- 338.10 Uses Permitted

Ch. 3 Articles 340.12-368.10

- 340.12 Uses Not Permitted
- 342.30 Securing and Supporting
- 342.46 Bushings
- 344.30 Securing and Supporting
- 344.46 Bushings
- 348.30 Securing and Supporting
- 348.42 Couplings and Connectors
- 348.60 Grounding and Bonding
- 350.30 Securing and Supporting
- 350.42 Couplings and Connectors
- 350.60 Grounding and Bonding
- 352.10 Uses Permitted
- 352.30 Securing and Supporting
- 353.10 Uses Permitted [High Density Polyethylene Conduit (Type HDPE)]
- 353.24 Bends — How Made

- 355.10 Uses Permitted
- 355.30 Securing and Supporting
- 358.10 Uses Permitted
- 358.30 Securing and Supporting
- 362.12 Uses Not Permitted
- 366.22 Number of Conductors
- 368.10 Uses Permitted (Busways)

Ch. 3 Articles 372.12-399

- Article 372 — Cellular Concrete Floor Raceways
- 372.12 Splices and Taps
- Article 376 — Metal Wireways
- 376.10 Uses Permitted
- Article 380 — Multi Outlet Assembly
- 380.23 Insulated Conductors (Multioutlet Assembly).
- Article 390 — Underfloor Raceways
- 390.2 Definition
- Article 392 — Cable Trays
- 392.18 Cable Tray Installation
- Article 396 — Messenger-Supported Wiring
- 396.10 Uses Permitted
- Article 399 — Outdoor Overhead Conductors over 600 Volts



2011 NEC[®] Code Changes – Chapter 3

Developed by National Green Building, Inc.

Course Description

The NFPA updates to the NEC Code periodically – you need to know the latest updates and the reasons for them.

This **interactive online** course provides you with everything you need to be familiar with the NEC Code – specifically the 2011 version. For all of the major Code changes covered, you'll get:

- A summary addressing each relevant Change.
- Excerpts of actual 2011 National Electrical Code text with relevant Staff comments and illustrations.
- First-time articles, usability improvements, and revisions that boost electrical safety making the 2008 National Electrical Code essential.

Performance Objectives

At the conclusion of this course, you will be able to:

- Identify the various significant changes in Chapter 3 of the NEC
- Recognize the reasons for changes to existing Code
- List new articles in the Code
- Describe deletions in some existing requirements

References

1. NFPA. *2011 National Electric Code (NEC)*, 2010
2. NFPA. *NEC Plus*, 2010
3. International Association of Electrical Inspectors. *NEC 2011 — Analysis of Changes*, 2010.
4. Mike Holt Enterprises. *Changes to the NEC 2011*, 2010

The designations "*National Electric Code*" and "*NEC*" refer to *NFPA 70, National Electric Code*, which is a registered trademark of the *National Fire Protection Association*.

NOTE:

The National Electric Code is intended for electricians and subcontractors, electrical inspectors, electrical engineers, designers, and other qualified persons who understand electrical currents, theory, safety procedures, and electrical trade practices. The code does not serve as a teaching manual for untrained individuals.

Chapter 3 — Wiring Methods and Materials

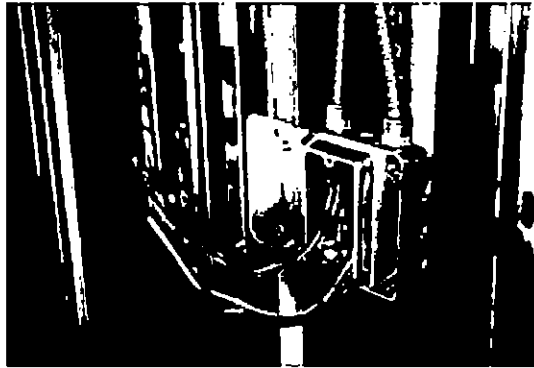

Chapter 3 covers wiring methods and materials, and provides some very specific installation requirements for conductors, cables, boxes, raceways, and fittings.

This chapter includes detailed information about installation and restrictions involved with wiring methods. The chapter begins with rules that are common to most wiring methods, it then covers conductors and enclosures. The articles that follow become more specific and deal in more depth with individual wiring methods such as specific types of cables and various raceways. The chapter winds up with article 392, a support system, and the final articles for open wiring

Article 300 — Wiring Methods

Article 300 contains the general requirements for all wiring methods included in the NEC. However the article does not apply to communications systems, which are covered in chapter 8, except when Article 300 is specifically referenced in chapter 8.

This article is primarily concerned with how to install, route, splice, protect, and secure conductors and raceways. Conformance to the requirements of article 300 will generally be show in the finished work, because many of the requirements tend to determine the appearance of the installation. Because of this, it's often easy to spot article 300 problems if you're looking for Code violations. For example, you can easily see when someone runs an equipment grounding conductor outside a raceway instead of grouping all conductors of the circuit together, which is required by 300.3(B).

I. General Requirements

300.3 Conductors

NEC Language

(A) **Single Conductors.** Single conductors specified in Table 310.104(A) shall only be installed where part of a recognized wiring method of Chapter 3.

Exception: Individual conductors shall be permitted where installed as separate overhead conductors in accordance with 225.6.

(B) **Conductors of the Same Circuit.** All conductors of the same circuit and, where used, the grounded conductor and all equipment grounding conductors and bonding conductors shall be contained within the same raceway, auxiliary gutter, cable tray, cablebus assembly, trench, cable, or cord, unless otherwise permitted in accordance with 300.3(B)(1) through (B)(4).

(1) **Paralleled Installations.** Conductors shall be permitted to be run in parallel in accordance with the provisions of 310.10(H). The requirement to run all circuit conductors within the same raceway, auxiliary gutter, cable tray, trench, cable, or cord shall apply separately to each portion of the paralleled installation, and the equipment grounding conductors shall comply with the provisions of 250.122. Parallel runs in cable tray shall comply with the provisions of 392.20(C).

Exception: Conductors installed in nonmetallic raceways run underground shall be permitted to be arranged as isolated phase installations. The raceways shall be installed in close proximity, and the conductors shall comply with the provisions of 300.20(B).

(2) **Grounding and Bonding Conductors.** Equipment grounding conductors shall be permitted to be installed outside a raceway or cable assembly where in accordance with the provisions of 250.130(C) for certain existing installations or in accordance with 250.134(B), Exception No. 2, for dc circuits. Equipment bonding conductors shall be permitted to be installed on the outside of raceways in accordance with 250.102(E).

(3) **Nonferrous Wiring Methods.** Conductors in wiring methods with a nonmetallic or other nonmagnetic sheath, where run in different raceways, auxiliary gutters, cable trays, trenches, cables, or cords, shall comply with the provisions of 300.20(B). Conductors in single-conductor Type MI cable with a nonmagnetic sheath shall comply with the provisions of 332.31. Conductors of single-conductor Type MC cable with a nonmagnetic sheath shall comply with the provisions of 330.31, 330.116, and 300.20(B).

(4) **Enclosures.** Where an auxiliary gutter runs between a column-width panelboard and a pull box, and the pull box includes neutral terminations, the neutral conductors of circuits supplied from the panelboard shall be permitted to originate in the pull box.

Changed From NEC 2008

300.3(C)(1) **Exception:** The Exception for solar photovoltaic systems was deleted, since these systems are covered in Chapter 6 which by the arrangement of the Code can amend the requirements of Chapter 3.

300.3(C)(1) **Informational Note:** To correlate with the deletion of the exception to 300.3(C)(1) an informational note was added to indicate that there are additional requirements in Article 690.

NEC Language

(C) Conductors of Different Systems.

(1) **600 Volts, Nominal, or Less.** Conductors of ac and dc circuits, rated 600 volts, nominal, or less, shall be permitted to occupy the same equipment wiring enclosure, cable, or raceway. All conductors shall have an insulation rating equal to at least the maximum circuit voltage applied to any conductor within the enclosure, cable, or raceway.

Informational Note No. 1: See 725.136(A) for Class 2 and Class 3 circuit conductors.

Informational Note No. 2: See 690.4(B) for photovoltaic source and output circuits.

300.4 Protection Against Physical Damage

Changed From NEC 2008

300.4: The terms "raceways" and "cables" were added to the opening sentence since they are covered in the rules.

NEC Language

Where subject to physical damage, conductors, raceways, and cables shall be protected.

(A) Cables and Raceways Through Wood Members.

(1) **Bored Holes.** In both exposed and concealed locations, where a cable- or raceway-type wiring method is installed through bored holes in joists, rafters, or wood members, holes shall be bored so that the edge of the hole is not less than 32 mm (1¼ in.) from the nearest edge of the wood member. Where this distance cannot be maintained, the cable or raceway shall be protected from penetration by screws or nails by a steel plate(s) or bushing(s), at least 1.6 mm (.06 in.) thick, and of appropriate length and width installed to cover the area of the wiring.

Exception No. 1: Steel plates shall not be required to protect rigid metal conduit, intermediate metal conduit, rigid nonmetallic conduit, or electrical metallic tubing.

Exception No. 2: A listed and marked steel plate less than 1.6 mm (.06 in.) thick that provides equal or better protection against nail or screw penetration shall be permitted.

(2) **Notches in Wood.** Where there is no objection because of weakening the building structure, in both exposed and concealed locations, cables or raceways shall be permitted to be laid in notches in wood studs, joists, rafters, or other wood members where the cable or raceway at those points is protected against nails or screws by a steel plate at least 1.6 mm (.06 in.) thick, and of appropriate length and width, installed to cover the area of the wiring. The steel plate shall be installed before the building finish is applied.

Exception No. 1: Steel plates shall not be required to protect rigid metal conduit, intermediate metal conduit, rigid nonmetallic conduit, or electrical metallic tubing.

Exception No. 2: A listed and marked steel plate less than 1.6 mm (.06 in.) thick that provides equal or better protection against nail or screw penetration shall be permitted.

(B) Nonmetallic-Sheathed Cables and Electrical Nonmetallic Tubing Through Metal Framing Members.

(1) **Nonmetallic-Sheathed Cable.** In both exposed and concealed locations where nonmetallic-sheathed cables pass through either factory- or field-punched, cut, or drilled slots or holes in metal members, the cable shall be protected by listed bushings or listed grommets covering all metal edges that are securely fastened in the opening prior to installation of the cable.

(2) **Nonmetallic-Sheathed Cable and Electrical Nonmetallic Tubing.** Where nails or screws are likely to penetrate nonmetallic-sheathed cable or electrical nonmetallic tubing, a steel sleeve, steel plate, or steel clip not less than 1.6 mm (in.) in thickness shall be used to protect the cable or tubing.

Exception: A listed and marked steel plate less than 1.6 mm (in.) thick that provides equal or better protection against nail or screw penetration shall be permitted.

(C) Cables Through Spaces Behind Panels Designed to Allow Access. Cables or raceway-type wiring methods, installed behind panels designed to allow access, shall be supported according to their applicable articles.

(D) Cables and Raceways Parallel to Framing Members and Furring Strips. In both exposed and concealed locations, where a cable- or raceway-type wiring method is installed parallel to framing members, such as joists, rafters, or studs, or is installed parallel to furring strips, the cable or raceway shall be installed and supported so that the nearest outside surface of the cable or raceway is not less than 32 mm (1¼ in.) from the nearest edge of the framing member or furring strips where nails or screws are likely to penetrate. Where this distance cannot be maintained, the cable or raceway shall be protected from penetration by nails or screws by a steel plate, sleeve, or equivalent at least 1.6 mm (in.) thick.

Exception No. 1: Steel plates, sleeves, or the equivalent shall not be required to protect rigid metal conduit, intermediate metal conduit, rigid nonmetallic conduit, or electrical metallic tubing.

Exception No. 2: For concealed work in finished buildings, or finished panels for prefabricated buildings where such supporting is impracticable, it shall be permissible to fish the cables between access points.

Exception No. 3: A listed and marked steel plate less than 1.6 mm (in.) thick that provides equal or better protection against nail or screw penetration shall be permitted.

Changed From NEC 2008

300.4(E) Cables, Raceways, or Boxes Installed in or Under Roof Decking: The NEC revised the title and text to include boxes and installations that are concealed in metal-corrugated roof systems. The section was also revised to clarify how the measurements from the underside of the roof deck to the top of the cable or raceway are made.

NEC Language

(E) Cables, Raceways, or Boxes Installed in or Under Roof Decking. A cable, raceway, or box, installed in exposed or concealed locations under metal-corrugated

sheet roof decking, shall be installed and supported so there is not less than 38 mm (1½ in.) measured from the lowest surface of the roof decking to the top of the cable, raceway, or box. A cable, raceway, or box shall not be installed in concealed locations in metal-corrugated, sheet decking-type roof.

Informational Note: Roof decking material is often repaired or replaced after the initial raceway or cabling and roofing installation and may be penetrated by the screws or other mechanical devices designed to provide "hold down" strength of the waterproof membrane or roof insulating material.

Exception: Rigid metal conduit and intermediate metal conduit shall not be required to comply with 300.4(E).

(F) Cables and Raceways Installed in Shallow Grooves. Cable- or raceway-type wiring methods installed in a groove, to be covered by wallboard, siding, paneling, carpeting, or similar finish, shall be protected by 1.6 mm (in.) thick steel plate, sleeve, or equivalent or by not less than 32-mm (1¼-in.) free space for the full length of the groove in which the cable or raceway is installed.

Exception No. 1: Steel plates, sleeves, or the equivalent shall not be required to protect rigid metal conduit, intermediate metal conduit, rigid nonmetallic conduit, or electrical metallic tubing.

Exception No. 2: A listed and marked steel plate less than 1.6 mm (in.) thick that provides equal or better protection against nail or screw penetration shall be permitted.

(G) Insulated Fittings. Where raceways contain 4 AWG or larger insulated circuit conductors, and these conductors enter a cabinet, a box, an enclosure, or a raceway, the conductors shall be protected by an identified fitting providing a smoothly rounded insulating surface, unless the conductors are separated from the fitting or raceway by identified insulating material that is securely fastened in place.

Exception. Where threaded hubs or bosses that are an integral part of a cabinet, box, enclosure, or raceway provide a smoothly rounded or flared entry for conductors.

Conduit bushings constructed wholly of insulating material shall not be used to secure a fitting or raceway. The insulating fitting or insulating material shall have a temperature rating not less than the insulation temperature rating of the installed conductors.

Changed From NEC 2008

<p>300.4(H) Structural Joints: Added text to clarify that a listed expansion/deflection fitting or other approved means is necessary when crossing a structural construction joint such as an expansion joint in buildings, bridges, parking garages, or other structures.</p>

NEC Language

(H) Structural Joints. A listed expansion/deflection fitting or other approved means shall be used where a raceway crosses a structural joint intended for expansion, contraction or deflection, used in buildings, bridges, parking garages, or other structures.

300.5 Underground Installations

NEC Language

(A) Minimum Cover Requirements. Direct-buried cable or conduit or other raceways shall be installed to meet the minimum cover requirements of Table 300.5.

Table 300.5 Minimum Cover Requirements, 0 to 600 Volts, Nominal, Burial in Millimeters (Inches)

Location of Wiring Method or Circuit	Type of Wiring Method or Circuit									
	Column 1 Direct Burial Cables or Conductors		Column 2 Rigid Metal Conduit or Intermediate Metal Conduit		Column 3 Nonmetallic Raceways Listed for Direct Burial Without Concrete Encasement or Other Approved Raceways		Column 4 Residential Branch Circuits Rated 120 Volts or Less with GFCI Protection and Maximum Overcurrent Protection of 20 Amperes		Column 5 Circuits for Control of Irrigation and Landscape Lighting Limited to Not More Than 30 Volts and Installed with Type UF or in Other Identified Cable or Raceway	
	mm	in.	mm	in.	mm	in.	mm	in.	mm	in.
All locations not specified below	600	24	150	6	450	18	300	12	150	6
In trench below 50-mm (2-in.) thick concrete or equivalent	450	18	150	6	300	12	150	6	150	6
Under a building	0 0 (in raceway or Type MC or Type MI cable identified for direct burial)		0 0		0 0		0 0 (in raceway or Type MC or Type MI cable identified for direct burial)		0 0 (in raceway or Type MC or Type MI cable identified for direct burial)	
Under minimum of 102-mm (4-in.) thick concrete exterior slab with no vehicular traffic and the slab extending not less than 152 mm (6 in.) beyond the underground installation	450 18		100 4		100 4		150 6 (direct burial)		150 6 (direct burial)	
							100 4 (in raceway)		100 4 (in raceway)	
Under streets, highways, roads, alleys, driveways, and parking lots	600	24	600	24	600	24	600	24	600	24
One- and two-family dwelling driveways and outdoor parking areas, and used only for dwelling-related purposes	450	18	450	18	450	18	300	12	450	18
In or under airport runways, including adjacent areas where trespassing prohibited	450	18	450	18	450	18	450	18	450	18

Notes:
 1. Cover is defined as the shortest distance in millimeters (inches) measured between a point on the top surface of any direct-buried conductor, cable, conduit, or other raceway and the top surface of finished grade, concrete, or similar cover.
 2. Raceways approved for burial only where concrete encased shall require concrete envelope not less than 50 mm (2 in.) thick.
 3. Lesser depths shall be permitted where cables and conductors rise for terminations or splices or where access is otherwise required.
 4. Where one of the wiring method types listed in Columns 1-3 is used for one of the circuit types in Columns 4 and 5, the shallowest depth of burial shall be permitted.
 5. Where solid rock prevents compliance with the cover depths specified in this table, the wiring shall be installed in metal or nonmetallic raceway permitted for direct burial. The raceways shall be covered by a minimum of 50 mm (2 in.) of concrete extending down to rock.

NEC 2011

Due to its size, it might be best to review the table using your copy of NEC 2011

(B) Wet Locations. The interior of enclosures or raceways installed underground shall be considered to be a wet location. Insulated conductors and cables installed in these enclosures or raceways in underground installations shall be listed for use in wet locations and shall comply with 310.10(C). Any connections or splices in an underground installation shall be approved for wet locations.

(C) Underground Cables Under Buildings. Underground cable installed under a building shall be in a raceway.

Changed From NEC 2008

300.5(C) Exception No. 1: This was added to permit MI cable to be installed without a raceway where suitably protected from physical damage and corrosive conditions.

NEC Language

Exception No. 1: Type MI Cable shall be permitted under a building without installation in a raceway where embedded in concrete, fill, or other masonry in accordance with 332.10(6) or in underground runs where suitably protected against physical damage and corrosive conditions in accordance with 332.10(10).

Changed From NEC 2008

300.5(C) Exception No. 2: This was added to provide conditions that would permit MC cable to be installed under a building without a raceway.

NEC Language

Exception No. 2: Type MC Cable listed for direct burial or concrete encasement shall be permitted under a building without installation in a raceway in accordance with 330.10(A)(5) and in wet locations in accordance with 330.10(11).

(D) Protection from Damage. Direct-buried conductors and cables shall be protected from damage in accordance with 300.5(D)(1) through (D)(4).

(1) Emerging from Grade. Direct-buried conductors and cables emerging from grade and specified in columns 1 and 4 of Table 300.5 shall be protected by enclosures or raceways extending from the minimum cover distance below grade required by 300.5(A) to a point at least 2.5 m (8 ft) above finished grade. In no case shall the protection be required to exceed 450 mm (18 in.) below finished grade.

(2) Conductors Entering Buildings. Conductors entering a building shall be protected to the point of entrance.

(3) Service Conductors. Underground service conductors that are not encased in concrete and that are buried 450 mm (18 in.) or more below grade shall have their location identified by a warning ribbon that is placed in the trench at least 300 mm (12 in.) above the underground installation.

(4) Enclosure or Raceway Damage. Where the enclosure or raceway is subject to physical damage, the conductors shall be installed in rigid metal conduit, intermediate metal conduit, Schedule 80 PVC conduit, or equivalent.

(E) Splices and Taps. Direct-buried conductors or cables shall be permitted to be spliced or tapped without the use of splice boxes. The splices or taps shall be made in accordance with 110.14(B).

(F) Backfill. Backfill that contains large rocks, paving materials, cinders, large or sharply angular substances, or corrosive material shall not be placed in an excavation where materials may damage raceways, cables, or other substructures or prevent adequate compaction of fill or contribute to corrosion of raceways, cables, or other substructures.

Where necessary to prevent physical damage to the raceway or cable, protection shall be provided in the form of granular or selected material, suitable running boards, suitable sleeves, or other approved means.

(G) **Raceway Seals.** Conduits or raceways through which moisture may contact live parts shall be sealed or plugged at either or both ends.

Informational Note: Presence of hazardous gases or vapors may also necessitate sealing of underground conduits or raceways entering buildings.

(H) **Bushing.** A bushing, or terminal fitting, with an integral bushed opening shall be used at the end of a conduit or other raceway that terminates underground where the conductors or cables emerge as a direct burial wiring method. A seal incorporating the physical protection characteristics of a bushing shall be permitted to be used in lieu of a bushing.

Changed From NEC 2008

300.5(I) **Exception No. 1:** This was revised by adding a new second sentence covering single conductor cable installations.

NEC Language

(I) **Conductors of the Same Circuit.** All conductors of the same circuit and, where used, the grounded conductor and all equipment grounding conductors shall be installed in the same raceway or cable or shall be installed in close proximity in the same trench.

Exception No. 1: Conductors shall be permitted to be installed in parallel in raceways, multiconductor cables, or direct-buried single conductor cables. Each raceway or multiconductor cable shall contain all conductors of the same circuit, including equipment grounding conductors. Each direct-buried single conductor cable shall be located in close proximity in the trench to the other single conductor cables in the same parallel set of conductors in the circuit, including equipment grounding conductors.

300.6 Protection Against Corrosion and Deterioration

NEC Language

Raceways, cable trays, cablebus, auxiliary gutters, cable armor, boxes, cable sheathing, cabinets, elbows, couplings, fittings, supports, and support hardware shall be of materials suitable for the environment in which they are to be installed.

Changed From NEC 2008

300.6(A) **Ferrous Metal Equipment:** This was revised to clarify that corrosion protection must be applied for threads where corrosion protection is necessary if it has not already been applied as part of the manufacturing process.

NEC Language

(A) **Ferrous Metal Equipment.** Ferrous metal raceways, cable trays, cablebus, auxiliary gutters, cable armor, boxes, cable sheathing, cabinets, metal elbows, couplings, nipples, fittings, supports, and support hardware shall be suitably protected against corrosion inside and outside (except threads at joints) by a coating of approved corrosion-resistant material. Where corrosion protection is necessary and the conduit is threaded in the field, the threads shall be coated with an approved electrically conductive, corrosion-resistant compound.

Exception: Stainless steel shall not be required to have protective coatings.

300.7 Raceways Exposed to Different Temperatures

Changed From NEC 2008

300.7(A) **Sealing:** The NEC revised the term “*cable raceways*” to “*raceways*.”

NEC Language

(A) **Sealing.** Where portions of a raceway or sleeve are known to be subjected to different temperatures, and where condensation is known to be a problem, as in cold storage areas of buildings or where passing from the interior to the exterior of a building, the raceway or sleeve shall be filled with an approved material to prevent the circulation of warm air to a colder section of the raceway or sleeve. An explosion-proof seal shall not be required for this purpose.

300.10 Electrical Continuity of Metal Raceways and Enclosures

Changed From NEC 2008

300.10: The NEC added a new second sentence to require independent support wires to be identified as specified to distinguish support wires for cables, raceways, etc. from those of the ceiling support system.

NEC Language

Metal raceways, cable armor, and other metal enclosures for conductors shall be metallically joined together into a continuous electrical conductor and shall be connected to all boxes, fittings, and cabinets so as to provide effective electrical continuity. Unless specifically permitted elsewhere in this Code, raceways and cable assemblies shall be mechanically secured to boxes, fittings, cabinets, and other enclosures.

Exception No. 1: Short sections of raceways used to provide support or protection of cable assemblies from physical damage shall not be required to be made electrically continuous.

Exception No. 2: Equipment enclosures to be isolated, as permitted by 250.96(B), shall not be required to be metallically joined to the metal raceway.

300.11 Securing and Supporting.

Changed From NEC 2008

The NEC added a new last sentence to 300.11(A)(2) requiring identification of independent wiring method support ceiling wires in non-fire-rated assemblies.

NEC Language

(A) **Secured in Place.** Raceways, cable assemblies, boxes, cabinets, and fittings shall be securely fastened in place. Support wires that do not provide secure support shall not be permitted as the sole support. Support wires and associated fittings that provide secure support and that are installed in addition to the ceiling grid support wires shall be permitted as the sole support. Where independent support wires are used, they shall be secured at both ends. Cables and raceways shall not be supported by ceiling grids.

(1) **Fire-Rated Assemblies.** Wiring located within the cavity of a fire-rated floor–ceiling or roof–ceiling assembly shall not be secured to, or supported by, the ceiling assembly, including the ceiling support wires. An independent means of secure support shall be

provided and shall be permitted to be attached to the assembly. Where independent support wires are used, they shall be distinguishable by color, tagging, or other effective means from those that are part of the fire-rated design.

Exception: The ceiling support system shall be permitted to support wiring and equipment that have been tested as part of the fire-rated assembly.

Wiring methods of any type and all luminaires are not allowed to be supported or secured to the support wires or T-bars of a fire-rated ceiling assembly unless the assembly has been tested and listed for that use. If support wires are selected as the supporting means for the electrical system within the fire-rated ceiling cavity, they must be distinguishable from the ceiling support wires and must be secured at both ends.

Generally, the rule for supporting electrical equipment is that the equipment must be "securely fastened in place." This phrase means not only that vertical support for the weight of the equipment must be provided but also that the equipment must be secured to prevent horizontal movement or sway. The intention is to prevent the loss of grounding continuity provided by the raceway that could result from horizontal movement.

Sections 300.11(A)(1) and (A)(2) are quite similar. Unless the exceptions apply, these sections clearly prohibit all types of wiring from being attached in any way to the support wires of a ceiling assembly. Unless ceiling grids are part of the building structure, they, too, are prohibited from furnishing support for cables and raceways. However, if wiring and equipment are located within the ceiling cavity and are rigidly supported independent of the ceiling, without the use of ceiling-type hanger wire, the requirements of this section are met. This section has been revised for the 2011 Code. Where independent support wires are used, they are required to be distinguishable by color, tagging, or other effective means. Often support wires for the ceiling have been indistinguishable from the wires installed for independent support of electrical equipment.

Refer to the appropriate wiring method article in Chapter 3 of the Code for cable and raceway supporting requirements. See Article 410, Part IV, for the proper support of luminaires; 314.23 for the support of outlet boxes; and 725.24, 760.24, and 770.24 for various low-voltage fire alarm and optical fiber cable supports. See Chapter 8 for communications cable supports.

Informational Note: One method of determining fire rating is testing in accordance with NFPA 251-2006, Standard Methods of Tests of Fire Resistance of Building Construction and Materials.

(2) Non-Fire-Rated Assemblies. Wiring located within the cavity of a non-fire-rated floor-ceiling or roof-ceiling assembly shall not be secured to, or supported by, the ceiling assembly, including the ceiling support wires. An independent means of secure support shall be provided and shall be permitted to be attached to the assembly. Where independent support wires are used, they shall be distinguishable by color, tagging, or other effective means.

Exception: The ceiling support system shall be permitted to support branch-circuit wiring and associated equipment where installed in accordance with the ceiling system manufacturer's instructions.

300.19 Supporting Conductors in Vertical Raceways

NEC Language

(A) **Spacing Intervals — Maximum.** Conductors in vertical raceways shall be supported if the vertical rise exceeds the values in Table 300.19(A). One cable support shall be provided at the top of the vertical raceway or as close to the top as practical. Intermediate supports shall be provided as necessary to limit supported conductor lengths to not greater than those values specified in Table 300.19(A).

Exception: Steel wire armor cable shall be supported at the top of the riser with a cable support that clamps the steel wire armor. A safety device shall be permitted at the lower end of the riser to hold the cable in the event there is slippage of the cable in the wire-armored cable support.

Additional wedge-type supports shall be permitted to relieve the strain on the equipment terminals caused by expansion of the cable under load.

Changed From NEC 2008

Table 300.19(A): The column heading was revised for consistency with the terminology used in the section.

Conductor Size	Support of Conductors in Vertical Raceways	Conductors			
		Aluminum or Copper-Clad Aluminum		Copper	
		m	ft	m	ft
18 AWG through 8 AWG	Not greater than	30	100	30	100
6 AWG through 1/0 AWG	Not greater than	60	200	30	100
2/0 AWG through 4/0 AWG	Not greater than	55	180	25	80
Over 4/0 AWG through 350 kcmil	Not greater than	41	135	18	60
Over 350 kcmil through 500 kcmil	Not greater than	36	120	15	50
Over 500 kcmil through 750 kcmil	Not greater than	28	95	12	40
Over 750 kcmil	Not greater than	26	85	11	35

NEC 2011

300.22 Wiring in Ducts Not Used for Air Handling, Fabricated Ducts for Environmental Air, and Other Spaces for Environmental Air (Plenums).

Changed From NEC 2008

300.22: This was revised to align the terminology regarding ducts, plenums, and other spaces used for environmental air with NFPA 90A. This simplifies the requirements based on the areas of installation, and a new part (C)(2) was inserted to cover cable trays in other spaces for environmental air (plenum).

NEC Language

The provisions of this section shall apply to the installation and uses of electrical wiring and equipment in ducts used for dust, loose stock, or vapor removal; ducts specifically fabricated for environmental air; and other spaces used for environmental air (plenums).

Informational Note: See Article 424, Part VI, for duct heaters.

(A) **Ducts for Dust, Loose Stock, or Vapor Removal.** No wiring systems of any type shall be installed in ducts used to transport dust, loose stock, or flammable vapors. No wiring system of any type shall be installed in any duct, or shaft containing only such ducts, used for vapor removal or for ventilation of commercial-type cooking equipment.

Changed From NEC 2008

300.22(B) **Ducts Specifically Fabricated for Environmental Air:** This was revised to clarify that the rule applies to plenums used specifically for the movement of environmental air.

NEC Language

(B) **Ducts Specifically Fabricated for Environmental Air.** Only wiring methods consisting of Type MI cable, Type MC cable employing a smooth or corrugated impervious metal sheath without an overall nonmetallic covering, electrical metallic tubing, flexible metallic tubing, intermediate metal conduit, or rigid metal conduit without an overall nonmetallic covering shall be installed in ducts specifically fabricated to transport environmental air. Flexible metal conduit shall be permitted, in lengths not to exceed 1.2 m (4 ft), to connect physically adjustable equipment and devices permitted to be in these fabricated ducts. The connectors used with flexible metal conduit shall effectively close any openings in the connection. Equipment and devices shall be permitted within such ducts only if necessary for the direct action upon, or sensing of, the contained air. Where equipment or devices are installed and illumination is necessary to facilitate maintenance and repair, enclosed gasketed-type luminaires shall be permitted.

Changed From NEC 2008

300.22(C) **Other Spaces Used for Environmental Air (Plenums):** This was revised to align the terminology regarding plenums and other spaces used for environmental air with NFPA 90A.

NEC Language

(C) **Other Spaces Used for Environmental Air (Plenums).** This section shall apply to spaces not specifically fabricated for environmental air-handling purposes but used for air-handling purposes as a plenum. This section shall not apply to habitable rooms or areas of buildings, the prime purpose of which is not air handling.

Informational Note No. 1: The space over a hung ceiling used for environmental air-handling purposes is an example of the type of other space to which this section applies.

Changed From NEC 2008

300.22(C) **Informational Note 2:** This was added to clarify that the terminology used in the section has been correlated with NFPA 90A and other relevant mechanical codes.

NEC Language

Informational Note No. 2: The phrase "Other Spaces Used for Environmental Air (Plenum)" as used in this section correlates with the use of the term "plenum" in NFPA 90A-2009, Standard for the Installation of Air-Conditioning and Ventilating Systems, and other mechanical codes where the plenum is used for return air purposes, as well as some other air-handling spaces.

Exception: This section shall not apply to the joist or stud spaces of dwelling units where the wiring passes through such spaces perpendicular to the long dimension of such spaces.

Changed From NEC 2008

300.22(C)(1) Wiring Methods: This was revised to clarify that the listing of the power cable is for use within an air-handling space.

NEC Language

(1) **Wiring Methods.** The wiring methods for such other space shall be limited to totally enclosed, nonventilated, insulated busway having no provisions for plug-in connections, Type MI cable, Type MC cable without an overall nonmetallic covering, Type AC cable, or other factory-assembled multiconductor control or power cable that is specifically listed for use within an air-handling space, or listed prefabricated cable assemblies of metallic manufactured wiring systems without nonmetallic sheath. Other types of cables, conductors, and raceways shall be permitted to be installed in electrical metallic tubing, flexible metallic tubing, intermediate metal conduit, rigid metal conduit without an overall nonmetallic covering, flexible metal conduit, or, where accessible, surface metal raceway or metal wireway with metal covers.

Changed From NEC 2008

300.22(C)(2) Cable Tray Systems: The NEC added requirements for metal cable tray systems installed in other spaces used for environmental air (plenum).

NEC Language

(2) **Cable Tray Systems.** The provisions in (a) or (b) shall apply to the use of metallic cable tray systems in other spaces used for environmental air (plenums), where accessible, as follows:

(a) **Metal Cable Tray Systems.** Metal cable tray systems shall be permitted to support the wiring methods in 300.22(C)(1).

(b) **Solid Side and Bottom Metal Cable Tray Systems.** Solid side and bottom metal cable tray systems with solid metal covers shall be permitted to enclose wiring methods and cables, not already covered in 300.22(C)(1), in accordance with 392.10(A) and (B).

(3) **Equipment.** Electrical equipment with a metal enclosure, or electrical equipment with a nonmetallic enclosure listed for use within an air-handling space and having adequate fire-resistant and low-smoke-producing characteristics, and associated wiring material suitable for the ambient temperature shall be permitted to be installed in such other space unless prohibited elsewhere in this Code.

Changed From NEC 2008

300.22(C)(3) Informational Note: This was added to provide information on an appropriate test method for determining adequate fire-resistant and low-smoke producing characteristics.

NEC Language

Informational Note: One method of defining adequate fire-resistant and low-smoke producing characteristics for electrical equipment with a nonmetallic enclosure is in ANSI/UL 2043-2008,

Fire Test for Heat and Visible Smoke Release for Discrete Products and Their Accessories Installed in Air-Handling Spaces.

Exception: Integral fan systems shall be permitted where specifically identified for use within an air-handling space.

(D) Information Technology Equipment. Electrical wiring in air-handling areas beneath raised floors for information technology equipment shall be permitted in accordance with Article 645.

II. Requirements for over 600 Volts, Nominal

300.37 Aboveground Wiring Methods

Changed From NEC 2008

300.37: This was revised by changing the reference to rigid nonmetallic conduit to RTRC and PVC.
--

NEC Language

Aboveground conductors shall be installed in rigid metal conduit, in intermediate metal conduit, in electrical metallic tubing, in **RTRC** and **PVC** conduit, in cable trays, in auxiliary gutters, as busways, as cablebus, in other identified raceways, or as exposed runs of metal-clad cable suitable for the use and purpose. In locations accessible to qualified persons only, exposed runs of Type MV cables, bare conductors, and bare busbars shall also be permitted. Busbars shall be permitted to be either copper or aluminum.

300.50 Underground Installations

(A) General. Underground conductors shall be identified for the voltage and conditions under which they are installed. Direct-burial cables shall comply with the provisions of 310.10(F). Underground cables shall be installed in accordance with 300.50(A)(1) or (A)(2), and the installation shall meet the depth requirements of **Table 300.50**.

Table 300.50 Minimum Cover^a Requirements

	General Conditions (not otherwise specified)						Special Conditions (use if applicable)					
	Column 1		Column 2		Column 3		Column 4		Column 5		Column 6	
	Direct-Buried Cables ^d		RTRC, PVC, and HDPE Conduit ^b		Rigid Metal Conduit and Intermediate Metal Conduit		Raceways Under Buildings or Exterior Concrete Slabs, 100 mm (4 in.) Minimum Thickness ^c		Cables in Airport Runways or Adjacent Areas Where Trespass Is Prohibited		Areas Subject to Vehicular Traffic, Such as Thoroughfares and Commercial Parking Areas	
Circuit Voltage	mm	in.	mm	in.	mm	in.	mm	in.	mm	in.	mm	in.
Over 600 V through 22 kV	750	30	450	18	150	6	100	4	450	18	600	24
Over 22 kV through 40 kV	900	36	600	24	150	6	100	4	450	18	600	24
Over 40 kV	1000	42	750	30	150	6	100	4	450	18	600	24

General Notes:
 1. Lesser depths shall be permitted where cables and conductors rise for terminations or splices or where access is otherwise required.
 2. Where solid rock prevents compliance with the cover depths specified in this table, the wiring shall be installed in a metal or nonmetallic raceway permitted for direct burial. The raceways shall be covered by a minimum of 50 mm (2 in.) of concrete extending down to rock.
 3. In industrial establishments, where conditions of maintenance and supervision ensure that qualified persons will service the installation, the minimum cover requirements, for other than rigid metal conduit and intermediate metal conduit, shall be permitted to be reduced 150 mm (6 in.) for each 50 mm (2 in.) of concrete or equivalent placed entirely within the trench over the underground installation.

Specific Footnotes:
^a Cover is defined as the shortest distance in millimeters (inches) measured between a point on the top surface of any direct-buried conductor, cable, conduit, or other raceway and the top surface of finished grade, concrete, or similar cover.
^b Listed by a qualified testing agency as suitable for direct burial without encasement. All other nonmetallic systems shall require 50 mm (2 in.) of concrete or equivalent above conduit in addition to the table depth.
^c The slab shall extend a minimum of 150 mm (6 in.) beyond the underground installation, and a warning ribbon or other effective means suitable for the conditions shall be placed above the underground installation.
^d Underground direct-buried cables that are not encased or protected by concrete and are buried 750 mm (30 in.) or more below grade shall have their location identified by a warning ribbon that is placed in the trench at least 300 mm (12 in.) above the cables.

NEC 2011

(1) Shielded Cables and Nonshielded Cables in Metal-Sheathed Cable Assemblies.

Underground cables, including nonshielded, Type MC and moisture-impervious metal sheath cables, shall have those sheaths grounded through an effective grounding path meeting the requirements of 250.4(A)(5) or (B)(4). They shall be direct buried or installed in raceways identified for the use.

(2) Other Nonshielded Cables. Other nonshielded cables not covered in 300.50(A)(1) shall be installed in rigid metal conduit, intermediate metal conduit, or rigid nonmetallic conduit encased in not less than 75 mm (3 in.) of concrete.

Changed From NEC 2008

300.50(B) Wet Locations: This was added to clarify that the inside of all raceways and enclosures installed underground are considered a wet location, regardless of voltage.

NEC Language

(B) Wet Locations. The interior of enclosures or raceways installed underground shall be considered to be a wet location. Insulated conductors and cables installed in these enclosures or raceways in underground installations shall be listed for use in wet locations and shall comply with 310.10(C). Any connections or splices in an underground installation shall be approved for wet locations.

Changed From NEC 2008

300.50(C) **Protection from Damage:** This was revised to recognize RTRC-XW as a method of protection.

NEC Language

(C) **Protection from Damage.** Conductors emerging from the ground shall be enclosed in listed raceways. Raceways installed on poles shall be of rigid metal conduit, intermediate metal conduit, RTRC-XW, Schedule 80 PVC conduit, or equivalent, extending from the minimum cover depth specified in Table 300.50 to a point 2.5 m (8 ft) above finished grade. Conductors entering a building shall be protected by an approved enclosure or raceway from the minimum cover depth to the point of entrance. Where direct-buried conductors, raceways, or cables are subject to movement by settlement or frost, they shall be installed to prevent damage to the enclosed conductors or to the equipment connected to the raceways. Metallic enclosures shall be grounded.

Article 310 — Conductors for General Wiring**NEC Language**

This article contains the general requirements for conductors, such as insulation markings, ampacity ratings, and conductor use. Article 310 does not apply to conductors that are part of flexible cords, fixture wires, or conductors that are an integral part of equipment.

Changed From NEC 2008

310: This Article was revised to comply with the NEC Manual of Style, to provide consistency with the formatting of other Chapter 3 articles. The reorganization is strictly editorial with no technical changes, other than technical changes that resulted from associated proposals related to Article 310.

You might want to review these changes using your copy of NEC 2011.

NEC Language

All tables located within Article 310 were renumbered in NEC 2011

Article revised into three parts with Part I, General; Part II, Installation Requirements; and Part III, Construction Requirements.

Allowable ampacity tables were renumbered to comply with the NEC Manual of Style.

Ampacity correction factors were consolidated into one section and two tables.

I. General

310.2 Definitions

Changed From NEC 2008

310.2: Definitions formerly located in 310.60 were relocated to 310.2 to apply to all conductors.

NEC Language

Electrical Ducts. Electrical conduits, or other raceways round in cross section, that are suitable for use underground or embedded in concrete.

Thermal Resistivity. As used in this Code, the heat transfer capability through a substance by conduction. It is the reciprocal of thermal conductivity and is designated Rho and expressed in the units °C-cm/W.

II. Installation

310.10 Uses Permitted

NEC Language

The conductors described in 310.104 shall be permitted for use in any of the wiring methods covered in Chapter 3 and as specified in their respective tables or as permitted elsewhere in this Code.

Informational Note: Thermoplastic insulation may stiffen at temperatures lower than -10°C (+14°F). Thermoplastic insulation may also be deformed at normal temperatures where subjected to pressure, such as at points of support. Thermoplastic insulation, where used on dc circuits in wet locations, may result in electroendosmosis between the conductor and insulation.

(A) **Dry Locations.** Insulated conductors and cables used in dry locations shall be any of the types identified in this Code.

(B) **Dry and Damp Locations.** Insulated conductors and cables used in dry and damp locations shall be Types FEP, FEPB, MTW, PFA, RHH, RHW, RHW-2, SA, THHN, THW, THW-2, THHW, THWN, THWN-2, TW, XHH, XHHW, XHHW-2, Z, or ZW.

(C) **Wet Locations.** Insulated conductors and cables used in wet locations shall comply with one of the following:

- (1) Be moisture-impervious metal-sheathed
- (2) Be types MTW, RHW, RHW-2, TW, THW, THW-2, THHW, THWN, THWN-2, XHHW, XHHW-2, ZW
- (3) Be of a type listed for use in wet locations

(D) **Locations Exposed to Direct Sunlight.** Insulated conductors or cables used where exposed to direct rays of the sun shall comply with (D)(1) or (D)(2):

- (1) Conductors and cables shall be listed, or listed and marked, as being sunlight resistant

- (2) Conductors and cables shall be covered with insulating material, such as tape or sleeving, that is listed, or listed and marked, as being sunlight resistant

Changed From NEC 2008

310.10(E) Shielding: The NEC revised the requirement to permit metallic insulation shields to be connected to equipment grounding conductors and to permit MC cable installations in industrial establishments where the phase-to-phase voltage between non-shielded conductors is not more than 5000 volts.

NEC Language

(E) **Shielding.** Non-shielded, ozone-resistant insulated conductors with a maximum phase-to-phase voltage of 5000 volts shall be permitted in Type MC cables in industrial establishments where the conditions of maintenance and supervision ensure that only qualified persons service the installation. For other establishments, solid dielectric insulated conductors operated above 2000 volts in permanent installations shall have ozone-resistant insulation and shall be shielded. All metallic insulation shields shall be connected to a grounding electrode conductor, a grounding busbar, an equipment grounding conductor, or a grounding electrode.

Changed From NEC 2008

310.10(E) Informational Note: The NEC revised the last sentence of 310.6 from 2008 edition as a new informational note to clarify the purpose of shielding.

NEC Language

Informational Note: The primary purposes of shielding are to confine the voltage stresses to the insulation, dissipate insulation leakage current, drain off the capacitive charging current, and carry ground-fault current to facilitate operation of ground-fault protective devices in the event of an electrical cable fault.

Exception No. 1: Nonshielded insulated conductors listed by a qualified testing laboratory shall be permitted for use up to 2400 volts under the following conditions:

- (a) Conductors shall have insulation resistant to electric discharge and surface tracking, or the insulated conductor(s) shall be covered with a material resistant to ozone, electric discharge, and surface tracking.
- (b) Where used in wet locations, the insulated conductor(s) shall have an overall nonmetallic jacket or a continuous metallic sheath.
- (c) Insulation and jacket thicknesses shall be in accordance with Table 310.104(D).

Changed From NEC 2008

310.10(E) Exception No. 2: This was revised to permit the use of 5000 volt non-shielded cables in certain existing industrial facilities under certain circumstances.

NEC Language

Exception No. 2: Nonshielded insulated conductors listed by a qualified testing laboratory shall be permitted for use up to 5000 volts to replace existing nonshielded conductors, on existing equipment in industrial establishments only, under the following conditions:

- (a) Where the condition of maintenance and supervision ensures that only qualified personnel install and service the installation.
- (b) Conductors shall have insulation resistant to electric discharge and surface tracking, or the insulated conductor(s) shall be covered with a material resistant to ozone, electric discharge, and surface tracking.
- (c) Where used in wet locations, the insulated conductor(s) shall have an overall nonmetallic jacket or a continuous metallic sheath.
- (d) Insulation and jacket thicknesses shall be in accordance with Table 310.13(D).

Informational Note: Relocation or replacement of equipment may not comply with the term existing as related to this exception.

Exception No. 3: Where permitted in 310.10(F), Exception No. 2.

Changed From NEC 2008

310.10(F) Direct-Burial Conductors: Deleted last sentence requiring cable rated above 2000 volts to be shielded.

NEC Language

(F) Direct-Burial Conductors. Conductors used for direct-burial applications shall be of a type identified for such use.

Exception No. 1: Nonshielded multiconductor cables rated 2001–2400 volts shall be permitted if the cable has an overall metallic sheath or armor.

The metallic shield, sheath, or armor shall be connected to a grounding electrode conductor, grounding busbar, or a grounding electrode.

Exception No. 2: Airfield lighting cable used in series circuits that are rated up to 5000 volts and are powered by regulators shall be permitted to be nonshielded.

Informational Note to Exception No. 2: Federal Aviation Administration (FAA) Advisory Circulars (ACs) provide additional practices and methods for airport lighting.

Informational Note No. 1: See 300.5 for installation requirements for conductors rated 600 volts or less.

Informational Note No. 2: See 300.50 for installation requirements for conductors rated over 600 volts.

(G) Corrosive Conditions. Conductors exposed to oils, greases, vapors, gases, fumes, liquids, or other substances having a deleterious effect on the conductor or insulation shall be of a type suitable for the application.

(H) Conductors in Parallel.

(1) General. Aluminum, copper-clad aluminum, or copper conductors, for each phase, polarity, neutral, or grounded circuit shall be permitted to be connected in parallel (electrically joined at both ends) only in sizes 1/0 AWG and larger where installed in accordance with 310.10(H)(2) through (H)(6).

Exception No. 1: Conductors in sizes smaller than 1/0 AWG shall be permitted to be run in parallel to supply control power to indicating instruments, contactors, relays, solenoids, and similar control devices, or for frequencies of 360 Hz and higher, provided all of the following apply:

- (a) They are contained within the same raceway or cable.
- (b) The ampacity of each individual conductor is sufficient to carry the entire load current shared by the parallel conductors.
- (c) The overcurrent protection is such that the ampacity of each individual conductor will not be exceeded if one or more of the parallel conductors become inadvertently disconnected.

Changed From NEC 2008

310.10(H)(1) Exception No. 2: This was revised to identify conductors smaller than 1/0 that can be installed as parallel conductors. Generally, conductors 1 AWG and smaller shall not run in parallel.

NEC Language

Exception No. 2: Under engineering supervision, 2 AWG and 1 AWG grounded neutral conductors shall be permitted to be installed in parallel for existing installations.

Informational Note to Exception No. 2: Exception No. 2 can be used to alleviate overheating of neutral conductors in existing installations due to high content of triplen harmonic currents.

(2) Conductor Characteristics. The paralleled conductors in each phase, polarity, neutral, grounded circuit conductor, equipment grounding conductor, or equipment bonding jumper shall comply with all of the following:

- (1) Be the same length
- (2) Consist of the same conductor material
- (3) Be the same size in circular mil area
- (4) Have the same insulation type
- (5) Be terminated in the same manner

(3) Separate Cables or Raceways. Where run in separate cables or raceways, the cables or raceways with conductors shall have the same number of conductors and shall have the same electrical characteristics. Conductors of one phase, polarity, neutral, grounded circuit conductor, or equipment grounding conductor shall not be required to have the same physical characteristics as those of another phase, polarity, neutral, grounded circuit conductor, or equipment grounding conductor.

(4) Ampacity Adjustment. Conductors installed in parallel shall comply with the provisions of 310.15(B)(3)(a).

(5) Equipment Grounding Conductors. Where parallel equipment grounding conductors are used, they shall be sized in accordance with 250.122. Sectioned equipment grounding conductors smaller than 1/0 AWG shall be permitted in multiconductor cables in accordance with 310.104, provided the combined circular mil area of the sectioned equipment grounding conductors in each cable complies with 250.122.

(6) Equipment Bonding Jumpers. Where parallel equipment bonding jumpers are installed in raceways, they shall be sized and installed in accordance with 250.102.

310.15 Ampacities for Conductors Rated 0–2000 Volts

NEC Language

(A) General.

(1) Tables or Engineering Supervision. Ampacities for conductors shall be permitted to be determined by tables as provided in 310.15(B) or under engineering supervision, as provided in 310.15(C).

Informational Note No. 1: Ampacities provided by this section do not take voltage drop into consideration. See 210.19(A), Informational Note No. 4, for branch circuits and 215.2(A), Informational Note No. 2, for feeders.

Informational Note No. 2. For the allowable ampacities of Type MTW wire, see Table 13.5.1 in NFPA 79-2007, Electrical Standard for Industrial Machinery.

(2) Selection of Ampacity. Where more than one ampacity applies for a given circuit length, the lowest value shall be used.

Exception: Where two different ampacities apply to adjacent portions of a circuit, the higher ampacity shall be permitted to be used beyond the point of transition, a distance equal to 3.0 m (10 ft) or 10 percent of the circuit length figured at the higher ampacity, whichever is less.

Changed From NEC 2008

310.15(A)(2) Informational Note: This was added to emphasize the need to include terminal temperature limitation considerations when calculating conductor size.

NEC Language

Informational Note: See 110.14(C) for conductor temperature limitations due to termination provisions.

Changed From NEC 2008

310.15(B) Tables: The NEC added new second paragraph to permit the ampacity adjustment and correction factors to be applied at the conductor temperature ratings as long as the resulting ampacity does not exceed the termination temperature rating.

NEC Language

(B) Tables. Ampacities for conductors rated 0 to 2000 volts shall be as specified in the Allowable Ampacity Table 310.15(B)(16) through Table 310.15(B)(19), and Ampacity Table 310.15(B)(20) and Table 310.15(B)(21) as modified by 310.15(B)(1) through (B)(7).

Highlight

A major revision was made to Article 310 which places all of the allowable ampacity tables for conductors rated 0 to 2000 volts under Section 310.15(B)(16) through 310.15(B)(19).

One of the most used tables, 310.16 is moved to 310.15(B)(16). The change also causes Tables 310.17 – 310.21 to now be labeled Table 310.15(B)(17) – Table 310.15(B)(21) respectively.

The reason for the change is to more accurately reflect the guidance of the NEC Style Manual which states "Tables and figures shall be referenced in the text and shall be designated by the number of the NEC rule in which they are referenced."

The NEC Style Manual is a tool used by the code making panel members as a guide to assist in making the NEC consistent and clear.

The Tables 310.15(B)(2)(a) and Table 310.15(B)(2)(b) for *Ambient Temperature Correction Factors* were also newly created and moved to their own table. These tables historically were at the bottom of Table 310.16 through 310.20. The intent is to consolidate temperature correction factors from seven tables down to two and place them in a section by themselves, thus providing more consistency.

Also worth noting is a change to Table 310.15(B)(6). This is the table to size dwelling services and feeders, and has now become Table 310.15(B)(7).

NEC Language

The temperature correction and adjustment factors shall be permitted to be applied to the ampacity for the temperature rating of the conductor, if the corrected and adjusted ampacity does not exceed the ampacity for the temperature rating of the termination in accordance with the provisions of 110.14(C).

(1) **General.** For explanation of type letters used in tables and for recognized sizes of conductors for the various conductor insulations, see Table 310.104(A) and Table 310.104(B). For installation requirements, see 310.1 through 310.15(A)(3) and the various articles of this Code. For flexible cords, see Table 400.4, Table 400.5(A)(1), and Table 400.5(A)(2).

Changed From NEC 2008

310.15(B)(2) Ambient Temperature Correction Factors: This was revised to require ambient temperatures other than what is specified in the applicable table to corrected in accordance with Table 310.15(B)(2)(a) or (b) or in accordance with the formula in the Code.

NEC Language

(2) **Ambient Temperature Correction Factors.** Ampacities for ambient temperatures other than those shown in the ampacity tables shall be corrected in accordance with Table 310.15(B)(2)(a) or Table 310.15(B)(2)(b), or shall be permitted to be calculated using the following equation:

$$I' = I \sqrt{\frac{T_c - T_a'}{T_c - T_a}}$$

where:

I' = ampacity corrected for ambient temperature

I = ampacity shown in the tables

T_c = temperature rating of conductor (°C)

T_a' = new ambient temperature (°C)

T_a = ambient temperature used in the table (°C)

Changed From NEC 2008

Table 310.15(B)(2)(a): The NEC added table that includes the ambient temperature correction factors formally located as part of Table 310.16 in the 2008 NEC. The table now includes some lower ambient temperatures.

Table 310.15(B)(2)(a) Ambient Temperature Correction Factors Based on 30°C (86°F)				
For ambient temperatures other than 30°C (86°F), multiply the allowable ampacities specified in the ampacity tables by the appropriate correction factor shown below.				
Ambient Temperature (°C)	Temperature Rating of Conductor			Ambient Temperature (°F)
	60°C	75°C	90°C	
10 or less	1.29	1.20	1.15	50 or less
11–15	1.22	1.15	1.12	51–59
16–20	1.15	1.11	1.08	60–68
21–25	1.08	1.05	1.04	69–77
26–30	1.00	1.00	1.00	78–86
31–35	0.91	0.94	0.96	87–95
36–40	0.82	0.88	0.91	96–104
41–45	0.71	0.82	0.87	105–113
46–50	0.58	0.75	0.82	114–122
51–55	0.41	0.67	0.76	123–131
56–60	—	0.58	0.71	132–140
61–65	—	0.47	0.65	141–149
66–70	—	0.33	0.58	150–158
71–75	—	—	0.50	159–167
76–80	—	—	0.41	168–176
81–85	—	—	0.29	177–185

Changed From NEC 2008

Table 310.15(B)(2)(b): This was added to provide the corrections factors for ambient temperatures other than 40°C.

Table 310.15(B)(2)(b) Ambient Temperature Correction Factors Based on 40°C (104°F)							
For ambient temperatures other than 40°C (104°F), multiply the allowable ampacities specified in the ampacity tables by the appropriate correction factor shown below.							
Ambient Temperature (°C)	Temperature Rating of Conductor						Ambient Temperature (°F)
	60°C	75°C	90°C	150°C	200°C	250°C	
10 or less	1.58	1.36	1.26	1.13	1.09	1.07	50 or less
11–15	1.50	1.31	1.22	1.11	1.08	1.06	51–59
16–20	1.41	1.25	1.18	1.09	1.06	1.05	60–68
21–25	1.32	1.2	1.14	1.07	1.05	1.04	69–77
26–30	1.22	1.13	1.10	1.04	1.03	1.02	78–86
31–35	1.12	1.07	1.05	1.02	1.02	1.01	87–95
36–40	1.00	1.00	1.00	1.00	1.00	1.00	96–104
41–45	0.87	0.93	0.95	0.98	0.98	0.99	105–113
46–50	0.71	0.85	0.89	0.95	0.97	0.98	114–122
51–55	0.50	0.76	0.84	0.93	0.95	0.96	123–131
56–60	—	0.65	0.77	0.90	0.94	0.95	132–140
61–65	—	0.53	0.71	0.88	0.92	0.94	141–149
66–70	—	0.38	0.63	0.85	0.90	0.93	150–158
71–75	—	—	0.55	0.83	0.88	0.91	159–167
76–80	—	—	0.45	0.80	0.87	0.90	168–176
81–90	—	—	—	0.74	0.83	0.87	177–194
91–100	—	—	—	0.67	0.79	0.85	195–212
101–110	—	—	—	0.60	0.75	0.82	213–230
111–120	—	—	—	0.52	0.71	0.79	231–248
121–130	—	—	—	0.43	0.66	0.76	249–266
131–140	—	—	—	0.30	0.61	0.72	267–284
141–160	—	—	—	—	0.50	0.65	285–320
161–180	—	—	—	—	0.35	0.58	321–356
181–200	—	—	—	—	—	0.49	357–392
201–225	—	—	—	—	—	0.35	393–437

NEC 2011

Changed From NEC 2008

Table 310.15(B)(3)(a)

Table 310.15(B)(3)(a) Adjustment Factors for More Than Three Current-Carrying Conductors in a Raceway or Cable	
Number of Conductors¹	Percent of Values in Table 310.15(B)(16) through Table 310.15(B)(19) as Adjusted for Ambient Temperature if Necessary
4–6	80
7–9	70
10–20	50
21–30	45
31–40	40
41 and above	35

¹Number of conductors is the total number of conductors in the raceway or cable adjusted in accordance with 310.15(B)(5) and (6).

NEC 2011

(b) **More Than One Conduit, Tube, or Raceway.** Spacing between conduits, tubing, or raceways shall be maintained.

Changed From NEC 2008

310.15(B)(3)(c) Circular Raceways Exposed to Sunlight on Rooftops: Title and text were revised to clarify that the rules apply to circular raceways.

NEC Language

(c) **Circular Raceways Exposed to Sunlight on Rooftops.** Where conductors or cables are installed in circular raceways exposed to direct sunlight on or above rooftops, the adjustments shown in Table 310.15(B)(3)(c) shall be added to the outdoor temperature to determine the applicable ambient temperature for application of the correction factors in Table 310.15(B)(2)(a) or Table 310.15(B)(2)(b).

Informational Note: One source for the average ambient temperatures in various locations is the ASHRAE Handbook — Fundamentals.

Changed From NEC 2008**Table 310.15(B)(3)(c)**

Table 310.15(B)(3)(c) Ambient Temperature Adjustment for Circular Raceways Exposed to Sunlight on or Above Rooftops		
Distance Above Roof to Bottom of Conduit	Temperature Adder	
	°C	°F
0–13 mm (½ in.)	33	60
Above 13 mm (½ in.)–90 mm (3½ in.)	22	40
Above 90 mm (3½ in.)–300 mm (12 in.)	17	30
Above 300 mm (12 in.)–900 mm (36 in.)	14	25

NEC 2011

Informational Note to Table 310.15(B)(3)(c): The temperature adders in Table 310.15(B)(3)(c) are based on the results of averaging the ambient temperatures.

Changed From NEC 2008

Table 310.15(B)(16)

The ampacity values were revised (Former Table 310.16)

Table 310.15(B)(16) (formerly Table 310.16) Allowable Ampacities of Insulated Conductors Rated Up to and Including 2000 Volts, 60°C Through 90°C (140°F Through 194°F), Not More Than Three Current-Carrying Conductors in Raceway, Cable, or Earth (Directly Buried), Based on Ambient Temperature of 30°C (86°F)*

Size AWG or kcmil	Temperature Rating of Conductor [See Table 310.104(A).]						Size AWG or kcmil
	60°C (140°F)	75°C (167°F)	90°C (194°F)	60°C (140°F)	75°C (167°F)	90°C (194°F)	
	Types TW, UF	Types RHW, THHW, THW, THWN, XHHW, USE, ZW	Types TBS, SA, SIS, FEP, FEPB, MI, RHH, RHW-2, THHN, THHW, THW-2, THWN-2, USE-2, XHH, XHHW, XHHW-2, ZW-2	Types TW, UF	Types RHW, THHW, THW, THWN, XHHW, USE	Types TBS, SA, SIS, THHN, THHW, THW-2, THWN-2, RHH, RHW-2, USE-2, XHH, XHHW, XHHW-2, ZW-2	
COPPER			ALUMINUM OR COPPER-CLAD ALUMINUM				
18	—	—	14	—	—	—	—
16	—	—	18	—	—	—	—
14**	15	20	25	—	—	—	—
12**	20	25	30	15	20	25	12**
10**	30	35	40	25	30	35	10**
8	40	50	55	35	40	45	8
6	55	65	75	40	50	55	6
4	70	85	95	55	65	75	4
3	85	100	115	65	75	85	3
2	95	115	130	75	90	100	2
1	110	130	145	85	100	115	1
1/0	125	150	170	100	120	135	1/0
2/0	145	175	195	115	135	150	2/0
3/0	165	200	225	130	155	175	3/0
4/0	195	230	260	150	180	205	4/0
250	215	255	290	170	205	230	250
300	240	285	320	195	230	260	300
350	260	310	350	210	250	280	350
400	280	335	380	225	270	305	400
500	320	380	430	260	310	350	500
600	350	420	475	285	340	385	600
700	385	460	520	315	375	425	700
750	400	475	535	320	385	435	750
800	410	490	555	330	395	445	800
900	435	520	585	355	425	460	900
1000	455	545	615	375	445	500	1000
1250	495	590	665	405	485	545	1250
1500	525	625	705	435	520	585	1500
1750	545	650	735	455	545	615	1750
2000	555	665	750	470	560	630	2000

*Refer to 310.15(B)(2) for the ampacity correction factors where the ambient temperature is other than 30°C (86°F).
 **Refer to 240.4(D) for conductor overcurrent protection limitations.

NEC 2011

This table may need to be viewed using your copy of NEC 2011

Table 310.15(B)(17) (formerly Table 310.17) Allowable Ampacities of Single-Insulated Conductors Rated Up to and Including 2000 Volts in Free Air, Based on Ambient Temperature of 30°C (86°F)*

Size AWG or kcmil	Temperature Rating of Conductor [Sec Table 310.104(A).]						Size AWG or kcmil
	60°C (140°F)	75°C (167°F)	90°C (194°F)	60°C (140°F)	75°C (167°F)	90°C (194°F)	
	Types TW, UF	Types RHW, THHW, THW, THWN, XHHW, ZW	Types TBS, SA, SIS, FEP, FEPB, MI, RHH, RHW-2, THHN, THHW, THW-2, THWN-2, USE-2, XHH, XHHW, XHHW-2, ZW-2	Types TW, UF	Types RHW, THHW, THW, THWN, XHHW	Types TBS, SA, SIS, THHN, THHW, THW-2, THWN-2, RHH, RHW-2, USE-2, XHH, XHHW, XHHW-2, ZW-2	
COPPER			ALUMINUM OR COPPER-CLAD ALUMINUM				
18	—	—	18	—	—	—	—
16	—	—	24	—	—	—	—
14**	25	30	35	—	—	—	—
12**	30	35	40	25	30	35	12**
10**	40	50	55	35	40	45	10**
8	60	70	80	45	55	60	8
6	80	95	105	60	75	85	6
4	105	125	140	80	100	115	4
3	120	145	165	95	115	130	3
2	140	170	190	110	135	150	2
1	165	195	220	130	155	175	1
1/0	195	230	260	150	180	205	1/0
2/0	225	265	300	175	210	235	2/0
3/0	260	310	350	200	240	270	3/0
4/0	300	360	405	235	280	315	4/0
250	340	405	455	265	315	355	250
300	375	445	500	290	350	395	300
350	420	505	570	330	395	445	350
400	455	545	615	355	425	480	400
500	515	620	700	405	485	545	500
600	575	690	780	455	545	615	600
700	630	755	850	500	595	670	700
750	655	785	885	515	620	700	750
800	680	815	920	535	645	725	800
900	730	870	980	580	700	790	900
1000	780	935	1055	625	750	845	1000
1250	890	1065	1200	710	855	965	1250
1500	980	1175	1325	795	950	1070	1500
1750	1070	1280	1445	875	1050	1185	1750
2000	1155	1385	1560	960	1150	1295	2000

*Refer to 310.15(B)(2) for the ampacity correction factors where the ambient temperature is other than 30°C (86°F).
 **Refer to 240.4(D) for conductor overcurrent protection limitations.

Table 310.15(B)(18) (formerly Table 310.18) Allowable Ampacities of Insulated Conductors Rated Up to and Including 2000 Volts, 150°C Through 250°C (302°F Through 482°F), Not More Than Three Current-Carrying Conductors in Raceway or Cable, Based on Ambient Air Temperature of 40°C (104°F)*

Size AWG or kcmil	Temperature Rating of Conductor [See Table 310.104(A)]				Size AWG or kcmil
	150°C (302°F)	200°C (392°F)	250°C (482°F)	150°C (302°F)	
	Type Z	Types FEP, FEPB, PFA, SA	Types PFAH, TFE	Type Z	
	COPPER		NICKEL OR NICKEL-COATED COPPER	ALUMINUM OR COPPER-CLAD ALUMINUM	
14	34	36	39	—	14
12	43	45	54	30	12
10	55	60	73	44	10
8	76	83	93	57	8
6	96	110	117	75	6
4	120	125	148	94	4
3	143	152	166	109	3
2	160	171	191	124	2
1	186	197	215	145	1
1/0	215	229	244	169	1/0
2/0	251	260	273	198	2/0
3/0	288	297	308	227	3/0
4/0	332	346	361	260	4/0

*Refer to 310.15(B)(2) for the ampacity correction factors where the ambient temperature is other than 40°C (104°F).

NEC 2011

Table 310.15(B)(19) (formerly Table 310.19) Allowable Ampacities of Single-Insulated Conductors, Rated Up to and Including 2000 Volts, 150°C Through 250°C (302°F Through 482°F), in Free Air, Based on Ambient Air Temperature of 40°C (104°F)*

Size AWG or kcmil	Temperature Rating of Conductor [See Table 310.104(A)]				Size AWG or kcmil
	150°C (302°F)	200°C (392°F)	250°C (482°F)	150°C (302°F)	
	Type Z	Types FEP, FEPB, PFA, SA	Types PFAH, TFE	Type Z	
	COPPER		NICKEL OR NICKEL-COATED COPPER	ALUMINUM OR COPPER-CLAD ALUMINUM	
14	46	54	59	—	14
12	60	68	78	47	12
10	80	90	107	63	10
8	106	124	142	83	8
6	155	165	205	112	6
4	190	220	278	148	4
3	214	252	327	170	3
2	255	293	381	198	2
1	293	344	440	228	1
1/0	339	399	532	263	1/0
2/0	390	467	591	305	2/0
3/0	451	546	708	351	3/0
4/0	529	629	830	411	4/0

*Refer to 310.15(B)(2) for the ampacity correction factors where the ambient temperature is other than 40°C (104°F).

NEC 2011

Table 310.15(B)(20) (formerly Table 310.20) Ampacities of Not More Than Three Single Insulated Conductors, Rated Up to and Including 2000 Volts, Supported on a Messenger, Based on Ambient Air Temperature of 40°C (104°F)*

Size AWG or kcmil	Temperature Rating of Conductor [See Table 310.104(A).]				Size AWG or kcmil
	75°C (167°F)	90°C (194°F)	75°C (167°F)	90°C (194°F)	
	Types RHW, THHW, THW, THWN, XHHW, ZW	Types MH, THHN, THHW, THW-2, THWN-2, RHH, RHW-2, USE-2, XHHW, XHHW-2, ZW-2	Types RHW, THW, THWN, THHW, XHHW	Types THHN, THHW, RHH, XHHW, RHW-2, XHHW-2, THW-2, THWN-2, USE-2, ZW-2	
	COPPER		ALUMINUM OR COPPER-CLAD ALUMINUM		
8	57	66	44	51	8
6	76	89	59	69	6
4	101	117	78	91	4
3	118	138	92	107	3
2	135	153	106	123	2
1	158	185	123	144	1
1/0	183	214	143	167	1/0
2/0	212	247	165	193	2/0
3/0	245	287	192	224	3/0
4/0	287	335	224	262	4/0
250	320	374	251	292	250
300	359	419	282	328	300
350	397	464	312	364	350
400	430	503	339	395	400
500	496	580	392	458	500
600	553	647	440	514	600
700	610	714	488	570	700
750	638	747	512	598	750
800	660	773	532	622	800
900	704	826	572	669	900
1000	748	879	612	716	1000

*Refer to 310.15(B)(2) for the ampacity correction factors where the ambient temperature is other than 40°C (104°F).

NEC 2011

Table 310.15(B)(21) (formerly Table 310.21) Ampacities of Bare or Covered Conductors in Free Air, Based on 40°C (104°F) Ambient, 80°C (176°F) Total Conductor Temperature, 610 m/sec (2 ft/sec) Wind Velocity

Copper Conductors				AAC Aluminum Conductors			
Bare		Covered		Bare		Covered	
AWG or kcmil	Amperes	AWG or kcmil	Amperes	AWG or kcmil	Amperes	AWG or kcmil	Amperes
8	98	8	103	8	76	8	80
6	124	6	130	6	96	6	101
4	155	4	163	4	121	4	127
2	209	2	219	2	163	2	171
1/0	282	1/0	297	1/0	220	1/0	231
2/0	329	2/0	344	2/0	255	2/0	268
3/0	382	3/0	401	3/0	297	3/0	312
4/0	444	4/0	466	4/0	346	4/0	364
250	494	250	519	266.8	403	266.8	423
300	556	300	584	336.4	468	336.4	492
500	773	500	812	397.5	522	397.5	548
750	1000	750	1050	477.0	588	477.0	617
1000	1193	1000	1253	556.5	650	556.5	682
—	—	—	—	636.0	709	636.0	744
—	—	—	—	795.0	819	795.0	860
—	—	—	—	954.0	920	—	—
—	—	—	—	1033.5	968	1033.5	1017
—	—	—	—	1272	1103	1272	1201
—	—	—	—	1590	1267	1590	1381
—	—	—	—	2000	1454	2000	1527

NEC 2011

310.60 Conductors Rated 2001 to 35,000 Volts

NEC Language

(A) Definitions.

Electrical Ducts. As used in Article 310, electrical ducts shall include any of the electrical conduits recognized in Chapter 3 as suitable for use underground; other raceways round in cross section, listed for underground use, and embedded in earth or concrete.

Thermal Resistivity. As used in this Code, the heat transfer capability through a substance by conduction. It is the reciprocal of thermal conductivity and is designated Rho and expressed in the units °C-cm/watt.

(B) Ampacities of Conductors Rated 2001 to 35,000 Volts. Ampacities for solid dielectric-insulated conductors shall be permitted to be determined by tables or under engineering supervision, as provided in 310.60(C) and (D).

(1) Selection of Ampacity. Where more than one calculated or tabulated ampacity could apply for a given circuit length, the lowest value shall be used.

Exception: Where two different ampacities apply to adjacent portions of a circuit, the higher ampacity shall be permitted to be used beyond the point of transition, a distance equal to 3.0 m (10 ft) or 10 percent of the circuit length calculated at the higher ampacity, whichever is less.

Informational Note: See 110.40 for conductor temperature limitations due to termination provisions.

(C) Tables. Ampacities for conductors rated 2001 to 35,000 volts shall be as specified in Table 310.60(C)(67) through Table 310.60(C)(86). Ampacities for ambient temperatures other than those specified in the ampacity tables shall be corrected in accordance with 310.60(C)(4).

Informational Note No. 1: For ampacities calculated in accordance with 310.60(B), reference IEEE 835-1994 (IPCEA Pub. No. P-46-426), Standard Power Cable Ampacity Tables, and the references therein for availability of all factors and constants.

Informational Note No. 2: Ampacities provided by this section do not take voltage drop into consideration. See 210.19(A), **Informational Note No. 4**, for branch circuits and 215.2(A), **Informational Note No. 2**, for feeders.

(1) Grounded Shields. Ampacities shown in Table 310.60(C)(69), Table 310.60(C)(70), Table 310.60(C)(81), and Table 310.60(C)(82) are for cable with shields grounded at one point only. Where shields are grounded at more than one point, ampacities shall be adjusted to take into consideration the heating due to shield currents.

(2) Burial Depth of Underground Circuits. Where the burial depth of direct burial or electrical duct bank circuits is modified from the values shown in a figure or table, ampacities shall be permitted to be modified as indicated in (C)(2)(a) and (C)(2)(b).

(a) Where burial depths are increased in part(s) of an electrical duct run, no decrease in ampacity of the conductors is needed, provided the total length of parts of the duct run increased in depth is less than 25 percent of the total run length.

(b) Where burial depths are deeper than shown in a specific underground ampacity table or figure, an ampacity derating factor of 6 percent per 300-mm (1-ft) increase in depth for all values of rho shall be permitted.

No rating change is needed where the burial depth is decreased.

(3) **Electrical Ducts in Figure 310.60.** At locations where electrical ducts enter equipment enclosures from under ground, spacing between such ducts, as shown in Figure 310.60, shall be permitted to be reduced without requiring the ampacity of conductors therein to be reduced.

Figure 310.60 Cable Installation Dimensions for Use with Table 310.60(C)(77) Through Table 310.60(C)(86).

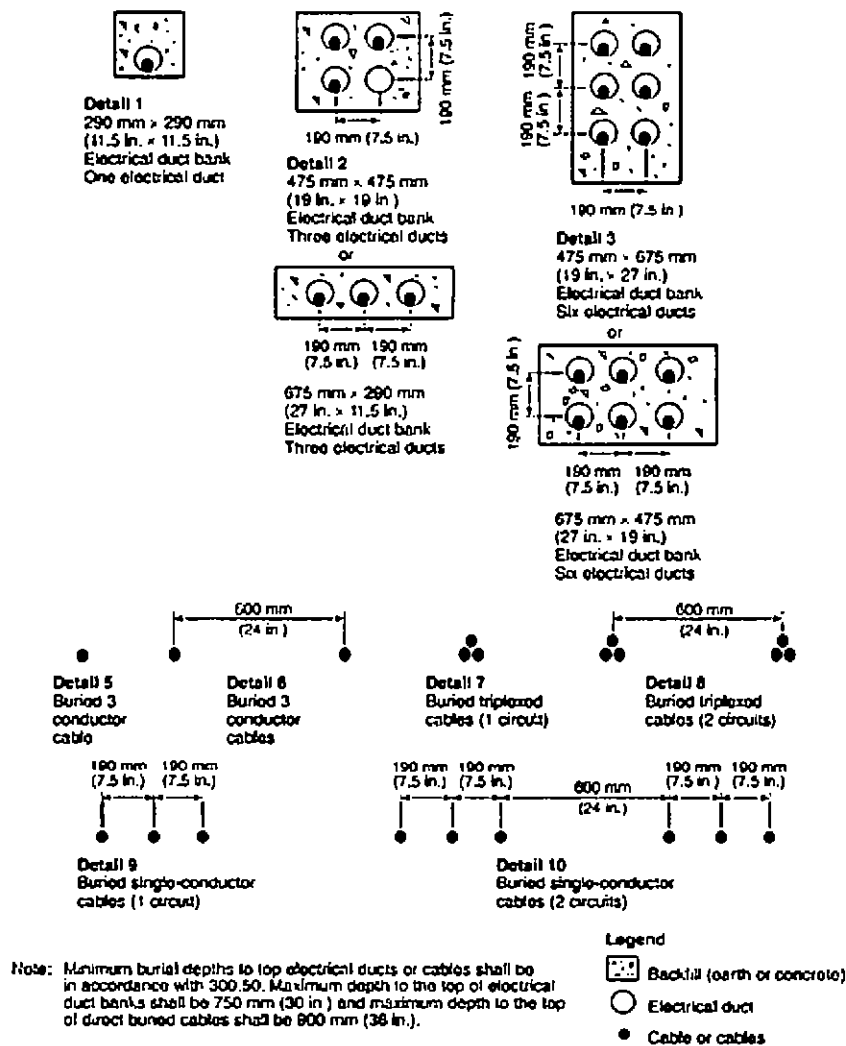

(4) **Ambient Temperature Correction.** Ampacities for ambient temperatures other than those specified in the ampacity tables shall be corrected in accordance with Table 310.60(C)(4) or shall be permitted to be calculated using the following equation:

$$I' = I \sqrt{\frac{T_c - T_a'}{T_c - T_a}}$$

where:

I' = ampacity corrected for ambient temperature

I = ampacity shown in the table for T_c and T_a

T_c = temperature rating of conductor (°C)

T_a' = new ambient temperature (°C)

T_a = ambient temperature used in the table (°C)

Table 310.60(C)(4) Ambient Temperature Correction Factors			
For ambient temperatures other than 40°C (104°F), multiply the allowable ampacities specified in the ampacity tables by the appropriate factor shown below.			
Ambient Temperature (°C)	Temperature Rating of Conductor		Ambient Temperature (°F)
	90°C	105°C	
10 or less	1.26	1.21	50 or less
11–15	1.22	1.18	51–59
16–20	1.18	1.14	60–68
21–25	1.14	1.11	69–77
26–30	1.10	1.07	78–86
31–35	1.05	1.04	87–95
36–40	1.00	1.00	96–104
41–45	0.95	0.96	105–113
46–50	0.89	0.92	114–122
51–55	0.84	0.88	123–131
56–60	0.77	0.83	132–140
61–65	0.71	0.78	141–149
66–70	0.63	0.73	150–158
71–75	0.55	0.68	159–167
76–80	0.45	0.62	168–176
81–85	0.32	0.55	177–185
86–90	—	0.48	186–194
91–95	—	0.39	195–203
96–100	—	0.28	204–212

Changed From NEC 2008

310.60(D) **Engineering Supervision:** This was revised to provide consistent terminology in the equation.

NEC Language

(D) **Engineering Supervision.** Under engineering supervision, conductor ampacities shall be permitted to be calculated by using the following general equation:

$$I = \sqrt{\frac{T_c - (T_a + \Delta T_d)}{R_{dc} (1 + Y_c) R_{ca}}} \times 10^3 \text{ amperes}$$

where:

T_c - conductor temperature (°C)

T_a - ambient temperature (°C)

T_d - dielectric loss temperature rise

R_{dc} - dc resistance of conductor at temperature T_c

Y_c - component ac resistance resulting from skin effect and proximity effect

R_{ca} - effective thermal resistance between conductor and surrounding ambient

Informational Note: The dielectric loss temperature rise (T_d) is negligible for single circuit extruded dielectric cables rated below 46 kV.

To review the following important Tables, please refer to your copy of NEC 2011.

Table 310.60(C)(67) Ampacities of Insulated Single Copper Conductor Cables Triplexed in Air Based on Conductor Temperatures of 90°C (194°F) and 105°C (221°F) and Ambient Air Temperature of 40°C (104°F)*

Table 310.60(C)(68) Ampacities of Insulated Single Aluminum Conductor Cables Triplexed in Air Based on Conductor Temperatures of 90°C (194°F) and 105°C (221°F) and Ambient Air Temperature of 40°C (104°F)*

Table 310.60(C)(69) Ampacities of Insulated Single Copper Conductor Isolated in Air Based on Conductor Temperatures of 90°C (194°F) and 105°C (221°F) and Ambient Air Temperature of 40°C (104°F)*

Table 310.60(C)(70) Ampacities of Insulated Single Aluminum Conductor Isolated in Air Based on Conductor Temperatures of 90°C (194°F) and 105°C (221°F) and Ambient Air Temperature of 40°C (104°F)*

Table 310.60(C)(71) Ampacities of an Insulated Three-Conductor Copper Cable Isolated in Air Based on Conductor Temperatures of 90°C (194°F) and 105°C (221°F) and Ambient Air Temperature of 40°C (104°F)*

Table 310.60(C)(72) Ampacities of an Insulated Three-Conductor Aluminum Cable Isolated in Air Based on Conductor Temperatures of 90°C (194°F) and 105°C (221°F) and Ambient Air Temperature of 40°C (104°F)*

Table 310.60(C)(73) Ampacities of an Insulated Triplexed or Three Single-Conductor Copper Cables in Isolated Conduit in Air Based on Conductor Temperatures of 90°C (194°F) and 105°C (221°F) and Ambient Air Temperature of 40°C (104°F)*

Table 310.60(C)(74) Ampacities of an Insulated Triplexed or Three Single-Conductor Aluminum Cables in Isolated Conduit in Air Based on Conductor Temperatures of 90°C (194°F) and 105°C (221°F) and Ambient Air Temperature of 40°C (104°F)*

Table 310.60(C)(75) Ampacities of an Insulated Three-Conductor Copper Cable in Isolated Conduit in Air Based on Conductor Temperatures of 90°C (194°F) and 105°C (221°F) and Ambient Air Temperature of 40°C (104°F)*

Table 310.60(C)(76) Ampacities of an Insulated Three-Conductor Aluminum Cable in Isolated Conduit in Air Based on Conductor Temperatures of 90°C (194°F) and 105°C (221°F) and Ambient Air Temperature of 40°C (104°F)*

Table 310.60(C)(77) Ampacities of Three Single-Insulated Copper Conductors in Underground Electrical Ducts (Three Conductors per Electrical Duct) Based on Ambient Earth Temperature of 20°C (68°F), Electrical Duct Arrangement in Accordance with Figure 310.60, 100 Percent Load Factor, Thermal Resistance (RHO) of 90, Conductor Temperatures of 90°C (194°F) and 105°C (221°F)

Table 310.60(C)(78) Ampacities of Three Single-Insulated Aluminum Conductors in Underground Electrical Ducts (Three Conductors per Electrical Duct) Based on Ambient Earth Temperature of 20°C (68°F), Electrical Duct Arrangement in Accordance with Figure 310.60, 100 Percent Load Factor, Thermal Resistance (RHO) of 90, Conductor Temperatures of 90°C (194°F) and 105°C (221°F)

Table 310.60(C)(79) Ampacities of Three Insulated Copper Conductors Cabled Within an Overall Covering (Three-Conductor Cable) in Underground Electrical Ducts (One Cable per Electrical Duct) Based on Ambient Earth Temperature of 20°C (68°F), Electrical Duct Arrangement in Accordance with Figure 310.60, 100 Percent Load Factor, Thermal Resistance (RHO) of 90, Conductor Temperatures of 90°C (194°F) and 105°C (221°C)

Table 310.60(C)(80) Ampacities of Three Insulated Aluminum Conductors Cabled Within an Overall Covering (Three-Conductor Cable) in Underground Electrical Ducts (One Cable per Electrical Duct) Based on Ambient Earth Temperature of 20°C (68°F), Electrical Duct Arrangement in Accordance with Figure 310.60, 100 Percent Load Factor, Thermal Resistance (RHO) of 90, Conductor Temperatures of 90°C (194°F) and 105°C (221°C)

Table 310.60(C)(81) Ampacities of Single Insulated Copper Conductors Directly Buried in Earth Based on Ambient Earth Temperature of 20°C (68°F), Arrangement per Figure 310.60, 100 Percent Load Factor, Thermal Resistance (RHO) of 90, Conductor Temperatures of 90°C (194°F) and 105°C (221°C)

Table 310.60(C)(82) Ampacities of Single Insulated Aluminum Conductors Directly Buried in Earth Based on Ambient Earth Temperature of 20°C (68°F), Arrangement per Figure 310.60, 100 Percent Load Factor, Thermal Resistance (RHO) of 90, Conductor Temperatures of 90°C (194°F) and 105°C (221°F)

Table 310.60(C)(83) Ampacities of Three Insulated Copper Conductors Cabled Within an Overall Covering (Three-Conductor Cable), Directly Buried in Earth Based on Ambient Earth Temperature of 20°C (68°F), Arrangement per Figure 310.60, 100 Percent Load Factor, Thermal Resistance (RHO) of 90, Conductor Temperatures of 90°C (194°F) and 105°C (221°F)

Table 310.60(C)(84) Ampacities of Three Insulated Aluminum Conductors Cabled Within an Overall Covering (Three-Conductor Cable), Directly Buried in Earth Based on Ambient Earth Temperature of 20°C (68°F), Arrangement per Figure 310.60, 100 Percent Load Factor, Thermal Resistance (RHO) of 90, Conductor Temperatures of 90°C (194°F) and 105°C (221°F)

Table 310.60(C)(85) Ampacities of Three Triplexed Single Insulated Copper Conductors Directly Buried in Earth Based on Ambient Earth Temperature of 20°C (68°F), Arrangement per Figure

310.60, 100 Percent Load Factor, Thermal Resistance (RHO) of 90, Conductor Temperatures 90°C (194°F) and 105°C (221°F)

Table 310.60(C)(86) Ampacities of Three Triplexed Single Insulated Aluminum Conductors Directly Buried in Earth Based on Ambient Earth Temperature of 20°C (68°F), Arrangement per Figure 310.60, 100 Percent Load Factor, Thermal Resistance (RHO) of 90, Conductor Temperatures 90°C (194°F) and 105°C (221°F)

III. Construction Specifications

Changed From NEC 2008

310 Part III: This was added to provide conductor construction specifications formally located in 310.13
--

310.104 Conductor Constructions and Applications

Insulated conductors shall comply with the applicable provisions of Table 310.104(A) through Table 310.104(E).

Informational Note: Thermoplastic insulation may stiffen at temperatures lower than -10°C (+14°F). Thermoplastic insulation may also be deformed at normal temperatures where subjected to pressure, such as at points of support. Thermoplastic insulation, where used on dc circuits in wet locations, may result in electroendosmosis between conductor and insulation.

Table 310.10-4(A) Conductor Applications and Insulations Rated 600 Volts

Trade Name	Type Letter	Maximum Operating Temperature	Application Provisions	Insulation	Thickness of insulation			Outer Covering ¹
					AWG or kcmil	mm	mil	
Fluorinated ethylene propylene	FEP or FEPB	90°C 194°F	Dry and damp locations	Fluorinated ethylene propylene	14-10 8-2	0.51 0.76	20 30	None
			Dry locations — special applications ²	Fluorinated ethylene propylene	14-8 6-2	0.36 0.36	14 14	Glass braid Glass or other suitable braid material
		200°C 392°F						
Mineral insulation (metal sheathed)	MI	90°C 194°F	Dry and wet locations	Magnesium oxide	18-16 ³ 16-10	0.58 0.91	23 36	Copper or alloy steel
		250°C 482°F	For special applications ²		9-4 3-500	1.27 1.40	50 55	
Moisture-, heat-, and oil-resistant thermoplastic	MTW	60°C 140°F	Machine tool wiring in wet locations	Flame-retardant, moisture-, heat-, and oil-resistant thermoplastic	22-12 10 8 6 4-2 1-40 213-500 501-1000	(A) (B)	(A) (B)	(A) None (B) Nylon jacket or equivalent
		90°C 194°F	Machine tool wiring in dry locations. Informational Note. See NFPA 79.			0.76 0.38 0.76 0.51 1.14 (0.76) 1.52 0.76 1.52 1.02 2.03 1.27 2.41 1.52 2.79 1.78	30 15 30 20 45 30 60 30 60 40 80 50 95 60 110 70	
Paper		85°C 185°F	For underground service conductors, or by special permission	Paper				Lead sheath
Perfluoro-alkoxy	PFA	90°C 194°F	Dry and damp locations	Perfluoro-alkoxy	14-10 8-2 1-40	0.51 0.76 1.14	20 30 45	None
		200°C 392°F	Dry locations — special applications ²					
Perfluoro-alkoxy	PFAH	250°C 482°F	Dry locations only. Only for leads within apparatus or within raceways connected to apparatus (nickel or nickel-coated copper only)	Perfluoro-alkoxy	14-10 8-2 1-40	0.51 0.76 1.14	20 30 45	None
Thermoset	RIB1	90°C 194°F	Dry and damp locations		14-10 8-2 1-40 213-500 501-1000 1001-2000	1.14 1.52 2.03 2.41 2.79 3.18	45 60 80 95 110 125	Moisture-resistant, flame-retardant, nonmetallic covering ¹
Moisture-resistant thermoset	RIFW	75°C 167°F	Dry and wet locations	Flame-retardant, moisture-resistant thermoset	14-10 8-2 1-40 213-500 501-1000 1001-2000	1.14 1.52 2.03 2.41 2.79 3.18	45 60 80 95 110 125	Moisture resistant, flame-retardant, nonmetallic covering
	RIFW-2	90°C 194°F						
Silicone	SA	90°C 194°F	Dry and damp locations	Silicone rubber	14-10 8-2 1-40 213-500 501-1000 1001-2000	1.14 1.52 2.03 2.41 2.79 3.18	45 60 80 95 110 125	Glass or other suitable braid material
		200°C 392°F	For special applications ²					

Please refer to your copy of NEC 2011 to review the large table above

Table 310.104(A) Continued

Trade Name	Type Letter	Maximum Operating Temperature	Application Provisions	Insulation	Thickness of Insulation			Outer Covering ¹
					AWG or kcmil	mm	mil	
Thermoset	SIS	90°C 194°F	Switchboard wiring only	Flame-retardant thermoset	14-10	0.76	30	None
					8-2	1.14	45	
					1-4/0	2.41	55	
Thermoplastic and fibrous outer braid	TIS	90°C 194°F	Switchboard wiring only	Thermoplastic	14-10	0.76	30	Flame-retardant, nonmetallic covering
					8	1.14	45	
					6-2	1.52	60	
					1-4/0	2.03	80	
Reticulated polytetrafluoroethylene	TTFE	250°C 482°F	Dry locations only. Only for leads within apparatus or within raceways connected to apparatus, or as open wiring (nickel or nickel-coated copper only)	Reticulated polytetrafluoroethylene	14-10	0.51	20	None
					8-2	0.76	30	
					1-4/0	1.14	45	
Heat-resistant thermoplastic	THHN	90°C 194°F	Dry and damp locations	Flame-retardant, heat-resistant thermoplastic	14-12	0.38	15	Nylon jacket or equivalent
					10	0.51	20	
					8-6	0.76	30	
					4-2	1.02	40	
					1-4/0	1.27	50	
					250-500 501-1000	1.52 1.78	60 70	
Moisture- and heat-resistant thermoplastic	THHW	75°C 167°F	Wet location	Flame-retardant, moisture- and heat-resistant thermoplastic	14-10	0.76	30	None
					8	1.14	45	
					6-2	1.52	60	
		90°C 194°F	Dry location		1-4/0	2.03	80	
					213-500	2.41	95	
					501-1000	2.79	110	
1001-2000	3.18	125						
Moisture- and heat-resistant thermoplastic	THW	75°C 167°F	Dry and wet locations	Flame-retardant, moisture- and heat-resistant thermoplastic	14-10	0.76	30	None
					8	1.14	45	
					6-2	1.52	60	
		90°C 194°F	Special applications within electric discharge lighting equipment. Limited to 1000 open-circuit volts or less. (size 14-3 only as permitted in 410.68)		1-4/0	2.03	80	
					213-500	2.41	95	
					501-1000	2.79	110	
1001-2000	3.18	125						
THW-2	90°C 194°F	Dry and wet locations			1-4/0	1.27	50	
					250-500	1.52	60	
501-1000	1.78	70						
Moisture- and heat-resistant thermoplastic	THWN	75°C 167°F	Dry and wet locations	Flame-retardant, moisture- and heat-resistant thermoplastic	14-12	0.38	15	Nylon jacket or equivalent
					10	0.51	20	
					8-6	0.76	30	
					4-2	1.02	40	
					1-4/0	1.27	50	
					250-500	1.52	60	
501-1000	1.78	70						
Moisture-resistant thermoplastic	TW	60°C 140°F	Dry and wet locations	Flame-retardant, moisture-resistant thermoplastic	14-10	0.76	30	None
					8	1.14	45	
					6-2	1.52	60	
					1-4/0	2.03	80	
					213-500	2.41	95	
					501-1000	2.79	110	
1001-2000	3.18	125						
Underground feeder and branch-circuit cable — single conductor (for Type UF cable employing more than one conductor, see Article 340.)	UF	60°C 140°F	See Article 340.	Moisture-resistant	14-10	1.52	60 ¹	Integral with insulation
					8-2	2.03	80 ¹	
		75°C 167°F ²		Moisture- and heat-resistant	1-4/0	2.41	95 ¹	

(Continued)

Please refer to your copy of NEC 2011 to review the large table above

Changed From NEC 2008

Table 310.104(A): This was added to provide the requirements formally found in Table 310.13(A).

Table 310.104(A) Continued								
Trade Name	Type Letter	Maximum Operating Temperature	Application Provisions	Insulation	Thickness of Insulation			Outer Covering ¹
					AWG or kcmil	mm	mils	
Underground service-entrance cable — single conductor (for Type USEH cable employing more than one conductor, see Article 338.)	USEH	75°C 167°F ²	See Article 338.	Heat- and moisture-resistant	14-10 8-2 1-4/0 213-500 501-1000 1001-2000	1.14 1.52 2.05 2.41 2.79 3.18	45 60 80 95 ³ 110 ³ 125	Moisture-resistant nonmetallic covering (See 338.2.)
	USE-2	90°C 194°F	Dry and wet locations					
Thermoset	XHHB	90°C 194°F	Dry and damp locations	Flame-retardant thermoset	14-10 8-2 1-4/0 213-500 501-1000 1001-2000	0.76 1.14 1.40 1.65 2.03 2.41	30 45 55 65 80 95	None
Moisture-resistant thermoset	XHHW	90°C 194°F 75°C 167°F	Dry and damp locations Wet locations	Flame-retardant, moisture-resistant thermoset	14-10 8-2 1-4/0 213-500 501-1000 1001-2000	0.76 1.14 1.40 1.65 2.03 2.41	30 45 55 65 80 95	None
Moisture-resistant thermoset	XHHW-2	90°C 194°F	Dry and wet locations	Flame-retardant, moisture-resistant thermoset	14-10 8-2 1-4/0 213-500 501-1000 1001-2000	0.76 1.14 1.40 1.65 2.03 2.41	30 45 55 65 80 95	None
Modified ethylene tetrafluoro-ethylene	Z	90°C 194°F 150°C 312°F	Dry and damp locations	Modified ethylene tetrafluoro-ethylene	14-12 10 8-4 3-1 10-4/0	0.38 0.51 0.64 0.89 1.14	15 20 25 35 45	None
			Dry locations — special applications ⁴					
Modified ethylene tetrafluoro-ethylene	Z/W	75°C 167°F 90°C 194°F 150°C 312°F	Wet locations	Modified ethylene tetrafluoro-ethylene	14-10 8-2	0.76 1.14	30 45	None
			Dry and damp locations					
	Z/W-2	90°C 194°F	Dry and wet locations					

¹ Some insulations do not require an outer covering.
² Where design conditions require maximum conductor operating temperatures above 90°C (194°F).
³ For signaling circuits permitting 300-volt insulation.
⁴ Includes integral jacket.
⁵ For ampacity limitation, see 340.10.
⁶ Insulation thickness shall be permitted to be 2.03 mm (80 mils) for listed Type USEH conductors that have been subjected to special investigations. The nonmetallic covering over individual rubber-covered conductors of aluminum-sheathed cable and of lead-sheathed or multiconductor cable shall not be required to be flame retardant. For Type MC cable, see 330.104. For nonmetallic-sheathed cable, see Article 334, Part III. For Type UF₂ cable, see Article 340, Part III.

NEC 2011

Please refer to your copy of NEC 2011 to review the large table above

To review the following important Tables, please refer to your copy of NEC 2011.

Table 310.104(B) Thickness of Insulation for Nonshielded Types RHH and RHW Solid Dielectric Insulated Conductors Rated 2000 Volts

Table 310.104(C) Conductor Application and Insulation Rated 2001 Volts and Higher

Table 310.104(D) Thickness of Insulation and Jacket for Nonshielded Solid Dielectric Insulated Conductors Rated 2001 to 5000 Volts

Table 310.104(E) Thickness of Insulation for Shielded Solid Dielectric Insulated Conductors
Rated 2001 to 35,000 Volts

312.8 Switch and Overcurrent Device Enclosures with Splices, Taps, and Feed-Through Conductors

Changed From NEC 2008

312.8: The title and text was reformatted for usability and clarity.

This section was revised to make it clearer when switch and overcurrent devices enclosures can contain splices, taps, and feed-through conductors.

The basic requirements for these conditions have not changed and all of these conditions must be met:

1. The total of all conductors installed at any cross section of the wiring space does not exceed 40 percent of the cross-sectional area of that space.
2. The total area of all conductors, splices, and taps installed at any cross section of the wiring space does not exceed 75 percent of the cross-sectional area of that space.

New in this section is a requirement that a warning label must also be applied to any enclosure that identifies the closest disconnecting means for any feed through conductors.

The wiring space of enclosures for switches or overcurrent devices shall be permitted for conductors feeding through, spliced, or tapping off to other enclosures, switches, or overcurrent devices where all of the following conditions are met:

- (1) The total of all conductors installed at any cross section of the wiring space does not exceed 40 percent of the cross-sectional area of that space.
- (2) The total area of all conductors, splices, and taps installed at any cross section of the wiring space does not exceed 75 percent of the cross-sectional area of that space.

Changed From NEC 2008

312.8(3): This was added to require a label on the enclosure identifying the location of the closest disconnecting means for feed-through conductors.

NEC Language

(3) A warning label must be applied to the enclosure that identifies the closest disconnecting means for any feed-through conductors.

II. Construction Specifications

312.10 Material

NEC Language

Cabinets, cutout boxes, and meter socket enclosures shall comply with 312.10(A) through (C).

(A) **Metal Cabinets and Cutout Boxes.** Metal enclosures within the scope of this article shall be protected both inside and outside against corrosion.

Informational Note: For information on protection against corrosion, see 300.6.

Changed From NEC 2008

312.10(B) A new requirement was added to Article 312 that will require all sharp edges of metal enclosures within this Article's scope that are subject to hand contact during typical installation activity to be protected or de-burred and rounded to minimize the risk of injury.

This activity shall take effect at the time of manufacturing.

While a sharp metal edge poses a cutting hazard to the installer, it is also a potential risk to conductor insulation. When the insulation of a conductor is damaged in any way, the conductor may come in contact with the exposed metal and cause a circuit short or arc flash condition. Obviously this requirement will be a subjective one to enforce but the intent is to minimize the hazards associated with sharp metal edges.

NEC Language

(B) **Strength.** The design and construction of enclosures within the scope of this article shall be such as to secure ample strength and rigidity. If constructed of sheet steel, the metal thickness shall not be less than 1.35 mm (0.053 in.) uncoated.

(C) **Nonmetallic Cabinets.** Nonmetallic cabinets shall be listed, or they shall be submitted for approval prior to installation.

Article 314 — Outlet, Device, Pull, and Junction Boxes; Conduit Bodies; Fittings; and Handhole Enclosures

This article contains installation requirements for outlet boxes, as well as conduit bodies and handhole enclosures.

II. Installation

314.21 Repairing Noncombustible Surfaces

Changed From NEC 2008

314.21: This was revised to recognize that noncombustible surfaces are not limited to plaster, plaster board, or drywall.

NEC Language

Noncombustible surfaces that are broken or incomplete around boxes employing a flush-type cover or faceplate shall be repaired so there will be no gaps or open spaces greater than 3 mm (1/8 in.) at the edge of the box.

314.23 Supports**NEC Language**

Enclosures within the scope of this article shall be supported in accordance with one or more of the provisions in 314.23(A) through (H).

(A) **Surface Mounting.** An enclosure mounted on a building or other surface shall be rigidly and securely fastened in place. If the surface does not provide rigid and secure support, additional support in accordance with other provisions of this section shall be provided.

(B) **Structural Mounting.** An enclosure supported from a structural member of a building or from grade shall be rigidly supported either directly or by using a metal, polymeric, or wood brace.

(1) **Nails and Screws.** Nails and screws, where used as a fastening means, shall be attached by using brackets on the outside of the enclosure, or they shall pass through the interior within 6 mm (1/4 in.) of the back or ends of the enclosure. Screws shall not be permitted to pass through the box unless exposed threads in the box are protected using approved means to avoid abrasion of conductor insulation.

(2) **Braces.** Metal braces shall be protected against corrosion and formed from metal that is not less than 0.51 mm (0.020 in.) thick uncoated. Wood braces shall have a cross section not less than nominal 25 mm × 50 mm (1 in. × 2 in.). Wood braces in wet locations shall be treated for the conditions. Polymeric braces shall be identified as being suitable for the use.

(C) **Mounting in Finished Surfaces.** An enclosure mounted in a finished surface shall be rigidly secured thereto by clamps, anchors, or fittings identified for the application.

(D) **Suspended Ceilings.** An enclosure mounted to structural or supporting elements of a suspended ceiling shall be not more than 1650 cm³ (100 in.³) in size and shall be securely fastened in place in accordance with either (D)(1) or (D)(2).

(1) **Framing Members.** An enclosure shall be fastened to the framing members by mechanical means such as bolts, screws, or rivets, or by the use of clips or other securing means identified for use with the type of ceiling framing member(s) and enclosure(s) employed. The framing members shall be adequately supported and securely fastened to each other and to the building structure.

(2) **Support Wires.** The installation shall comply with the provisions of 300.11(A). The enclosure shall be secured, using methods identified for the purpose, to ceiling support wire(s), including any additional support wire(s) installed for that purpose. Support wire(s) used for enclosure support shall be fastened at each end so as to be taut within the ceiling cavity.

(E) Raceway Supported Enclosure, Without Devices, Luminaires, or Lampholders. An enclosure that does not contain a device(s) other than splicing devices or support a luminaire(s), lampholder, or other equipment and is supported by entering raceways shall not exceed 1650 cm³ (100 in.³) in size. It shall have threaded entries or have hubs identified for the purpose. It shall be supported by two or more conduits threaded wrenchtight into the enclosure or hubs. Each conduit shall be secured within 900 mm (3 ft) of the enclosure, or within 450 mm (18 in.) of the enclosure if all conduit entries are on the same side.

Changed From NEC 2008

314.23(E) Exception: This was revised by changing to a list format for usability.

NEC Language

Exception: The following wiring methods shall be permitted to support a conduit body of any size, including a conduit body constructed with only one conduit entry, if the trade size of the conduit body is not larger than the largest trade size of the conduit or tubing:

- (1) Intermediate metal conduit, Type IMC
- (2) Rigid metal conduit, Type RMC
- (3) Rigid polyvinyl chloride conduit, Type PVC
- (4) Reinforced thermosetting resin conduit, Type RTRC
- (5) Electrical metallic tubing, Type EMT

314.24 Depth of Boxes

Changed From NEC 2008

314.24(A) Outlet Boxes Without Enclosed Devices or Utilization Equipment: The text was revised to apply to boxes that do not contain devices or utilization equipment.

NEC Language

(A) Outlet Boxes Without Enclosed Devices or Utilization Equipment. Outlet boxes that do not enclose devices or utilization equipment shall have a minimum internal depth of 12.7 mm (½ in.).

Changed From NEC 2008

314.24(C): This was revised to combine the requirements of 314.24(C) with the requirements of 314.24(B).

Outlet and device boxes shall have sufficient depth to allow equipment installed within them to be mounted properly and without likelihood of damage to conductors within the box.

Changed From NEC 2008

314.24(B) Outlet and Device Boxes with Enclosed Devices or Utilization Equipment: This was revised by combining the requirements for boxes enclosing devices or utilization equipment. The possibility of damaging a wire at the back of a box applies in both applications.

NEC Language

(B) **Outlet and Device Boxes with Enclosed Devices or Utilization Equipment.** Outlet and device boxes that enclose devices or utilization equipment shall have a minimum internal depth that accommodates the rearward projection of the equipment and the size of the conductors that supply the equipment. The internal depth shall include, where used, that of any extension boxes, plaster rings, or raised covers. The internal depth shall comply with all applicable provisions of (B)(1) through (B)(5).

(1) **Large Equipment.** Boxes that enclose devices or utilization equipment that projects more than 48 mm (1 in.) rearward from the mounting plane of the box shall have a depth that is not less than the depth of the equipment plus 6 mm (¼ in.).

(2) **Conductors Larger Than 4 AWG.** Boxes that enclose devices or utilization equipment supplied by conductors larger than 4 AWG shall be identified for their specific function.

Changed From NEC 2008

314.24(B)(2) **Exception:** This was added to permit devices or utilization equipment to be mounted on or in junction and pull boxes larger than 100 in³ with terminal spacing meeting the requirements of 312.6.

NEC Language

Exception to (2): Devices or utilization equipment supplied by conductors larger than 4 AWG shall be permitted to be mounted on or in junction and pull boxes larger than 1650 cm³ (100 in.³) if the spacing at the terminals meets the requirements of 312.6.

314.27 Outlet Boxes**Changed From NEC 2008**

314.27: This was revised to align the requirements in the text with the specific application indicated in the titles, and by simplifying the text.

NEC Language

(A) **Boxes at Luminaire or Lampholder Outlets.** Outlet boxes or fittings designed for the support of luminaires and lampholders, and installed as required by 314.23, shall be permitted to support a luminaire or lampholder.

Changed From NEC 2008

314.27(A)(1) **Wall Outlets:** This was revised by adding the requirement for the required weight marking to be on the inside of the box.

NEC Language

(1) **Wall Outlets.** Boxes used at luminaire or lampholder outlets in a wall shall be marked on the interior of the box to indicate the maximum weight of the luminaire that is permitted to be supported by the box in the wall, if other than 23 kg (50 lb).

Exception: A wall-mounted luminaire or lampholder weighing not more than 3 kg (6 lb) shall be permitted to be supported on other boxes or plaster rings that are secured to other boxes.

provided the luminaire or its supporting yoke, or the lampholder, is secured to the box with no fewer than two No. 6 or larger screws.

(2) **Ceiling Outlets.** At every outlet used exclusively for lighting, the box shall be designed or installed so that a luminaire or lampholder may be attached. Boxes shall be required to support a luminaire weighing a minimum of 23 kg (50 lb). A luminaire that weighs more than 23 kg (50 lb) shall be supported independently of the outlet box, unless the outlet box is listed and marked for the maximum weight to be supported.

(B) **Floor Boxes.** Boxes listed specifically for this application shall be used for receptacles located in the floor.

Exception: Where the authority having jurisdiction judges them free from likely exposure to physical damage, moisture, and dirt, boxes located in elevated floors of show windows and similar locations shall be permitted to be other than those listed for floor applications. Receptacles and covers shall be listed as an assembly for this type of location.

(C) **Boxes at Ceiling-Suspended (Paddle) Fan Outlets.** Outlet boxes or outlet box systems used as the sole support of a ceiling-suspended (paddle) fan shall be listed, shall be marked by their manufacturer as suitable for this purpose, and shall not support ceiling-suspended (paddle) fans that weigh more than 32 kg (70 lb). For outlet boxes or outlet box systems designed to support ceiling-suspended (paddle) fans that weigh more than 16 kg (35 lb), the required marking shall include the maximum weight to be supported.

Where spare, separately switched, ungrounded conductors are provided to a ceiling mounted outlet box, in a location acceptable for a ceiling-suspended (paddle) fan in single or multi-family dwellings, the outlet box or outlet box system shall be listed for sole support of a ceiling-suspended (paddle) fan.

Changed From NEC 2008

<p>314.27(D) Utilization Equipment: This was added to require an outlet box or outlet box system listed for the sole support of a ceiling-suspended (paddle) fan where spare switched ungrounded conductors are left at outlets in locations acceptable for mounting a ceiling-suspended fan in single or multi-family dwellings.</p>
--

NEC Language

(D) **Utilization Equipment.** Boxes used for the support of utilization equipment other than ceiling-suspended (paddle) fans shall meet the requirements of 314.27(A) for the support of a luminaire that is the same size and weight.

Exception: Utilization equipment weighing not more than 3 kg (6 lb) shall be permitted to be supported on other boxes or plaster rings that are secured to other boxes, provided the equipment or its supporting yoke is secured to the box with no fewer than two No. 6 or larger screws.

314.28 Pull and Junction Boxes and Conduit Bodies

NEC Language

Boxes and conduit bodies used as pull or junction boxes shall comply with 314.28(A) through (E).

Exception: Terminal housings supplied with motors shall comply with the provisions of 430.12.

(A) **Minimum Size.** For raceways containing conductors of 4 AWG or larger that are required to be insulated, and for cables containing conductors of 4 AWG or larger, the minimum dimensions of pull or junction boxes installed in a raceway or cable run shall comply with (A)(1) through (A)(3). Where an enclosure dimension is to be calculated based on the diameter of entering raceways, the diameter shall be the metric designator (trade size) expressed in the units of measurement employed.

Changed From NEC 2008

314.28(A)(1) & (2): This was revised to include conduit bodies in the requirement.

NEC Language

(1) **Straight Pulls.** In straight pulls, the length of the box or conduit body shall not be less than eight times the metric designator (trade size) of the largest raceway.

(2) **Angle or U Pulls, or Splices.** Where splices or where angle or U pulls are made, the distance between each raceway entry inside the box or conduit body and the opposite wall of the box or conduit body shall not be less than six times the metric designator (trade size) of the largest raceway in a row. This distance shall be increased for additional entries by the amount of the sum of the diameters of all other raceway entries in the same row on the same wall of the box. Each row shall be calculated individually, and the single row that provides the maximum distance shall be used.

Exception: Where a raceway or cable entry is in the wall of a box or conduit body opposite a removable cover, the distance from that wall to the cover shall be permitted to comply with the distance required for one wire per terminal in Table 312.6(A).

The distance between raceway entries enclosing the same conductor shall not be less than six times the metric designator (trade size) of the larger raceway.

When transposing cable size into raceway size in 314.28(A)(1) and (A)(2), the minimum metric designator (trade size) raceway required for the number and size of conductors in the cable shall be used.

(3) **Smaller Dimensions.** Boxes or conduit bodies of dimensions less than those required in 314.28(A)(1) and (A)(2) shall be permitted for installations of combinations of conductors that are less than the maximum conduit or tubing fill (of conduits or tubing being used) permitted by Table 1 of Chapter 9, provided the box or conduit body has been listed for, and is permanently marked with, the maximum number and maximum size of conductors permitted.

(B) **Conductors in Pull or Junction Boxes.** In pull boxes or junction boxes having any dimension over 1.8 m (6 ft), all conductors shall be cabled or racked up in an approved manner.

(C) **Covers.** All pull boxes, junction boxes, and conduit bodies shall be provided with covers compatible with the box or conduit body construction and suitable for the conditions of use. Where used, metal covers shall comply with the grounding requirements of 250.110.

(D) **Permanent Barriers.** Where permanent barriers are installed in a box, each section shall be considered as a separate box.

Changed From NEC 2008

314.28(E) Power Distribution Blocks: This was added to provide the requirements for distribution blocks mounted in junction or pull boxes over 100 in.3.

NEC Language

(E) Power Distribution Blocks. Power distribution blocks shall be permitted in pull and junction boxes over 1650 cm³ (100 in.3) for connections of conductors where installed in boxes and where the installation complies with (1) through (5).

Exception: Equipment grounding terminal bars shall be permitted in smaller enclosures.

(1) Installation. Power distribution blocks installed in boxes shall be listed.

(2) Size. In addition to the overall size requirement in the first sentence of 314.28(A)(2), the power distribution block shall be installed in a box with dimensions not smaller than specified in the installation instructions of the power distribution block.

(3) Wire Bending Space. Wire bending space at the terminals of power distribution blocks shall comply with 312.6.

(4) Live Parts. Power distribution blocks shall not have uninsulated live parts exposed within a box, whether or not the box cover is installed.

(5) Through Conductors. Where the pull or junction boxes are used for conductors that do not terminate on the power distribution block(s), the through conductors shall be arranged so the power distribution block terminals are unobstructed following installation.

314.30 Handhole Enclosures**NEC Language**

Handhole enclosures shall be designed and installed to withstand all loads likely to be imposed on them. They shall be identified for use in underground systems.

Informational Note: See ANSI/SCTE 77-2002, Specification for Underground Enclosure Integrity, for additional information on deliberate and nondeliberate traffic loading that can be expected to bear on underground enclosures.

(A) Size. Handhole enclosures shall be sized in accordance with 314.28(A) for conductors operating at 600 volts or below, and in accordance with 314.71 for conductors operating at over 600 volts. For handhole enclosures without bottoms where the provisions of 314.28(A)(2), Exception, or 314.71(B)(1), Exception No. 1, apply, the measurement to the removable cover shall be taken from the end of the conduit or cable assembly.

(B) Wiring Entries. Underground raceways and cable assemblies entering a handhole enclosure shall extend into the enclosure, but they shall not be required to be mechanically connected to the enclosure.

(C) Enclosed Wiring. All enclosed conductors and any splices or terminations, if present, shall be listed as suitable for wet locations.

Changed From NEC 2008

314.30(D) **Covers:** This was revised by changing the specific reference from 250.92(A) to 250.92 to make the entire section applicable.

NEC Language

(D) **Covers.** Handhole enclosure covers shall have an identifying mark or logo that prominently identifies the function of the enclosure, such as "electric." Handhole enclosure covers shall require the use of tools to open, or they shall weigh over 45 kg (100 lb). Metal covers and other exposed conductive surfaces shall be bonded in accordance with 250.92 if the conductors in the handhole are service conductors, or in accordance with 250.96(A) if the conductors in the handhole are feeder or branch-circuit conductors.

IV. Pull and Junction Boxes, Conduit Bodies, and Handhole Enclosures for Use on Systems over 600 Volts, Nominal**Changed From NEC 2008**

314 Part IV: The Title was revised to include conduit bodies and handhole enclosures.

314.70 General**Changed From NEC 2008**

314.70: The NEC added requirements for conduit bodies and handhole enclosures to the requirement for pull and junction boxes.

(A) **Pull and Junction Boxes.** Where pull and junction boxes are used on systems over 600 volts, the installation shall comply with the provisions of Part IV and with the following general provisions of this article:

- (1) Part I, 314.2; 314.3; and 314.4
- (2) Part II, 314.15; 314.17; 314.20; 314.23(A), (B), or (G); 314.28(B); and 314.29
- (3) Part III, 314.40(A) and (C); and 314.41

(B) **Conduit Bodies.** Where conduit bodies are used on systems over 600 volts, the installation shall comply with the provisions of Part IV and with the following general provisions of this article:

- (1) Part I, 314.4
- (2) Part II, 314.15; 314.17; 314.23(A), (E), or (G); and 314.29
- (3) Part III, 314.40(A); and 314.41

(C) **Handhole Enclosures.** Where handhole enclosures are used on systems over 600 volts, the installation shall comply with the provisions of Part IV and with the following general provisions of this article:

- (1) Part I, 314.3; and 314.4
- (2) Part II, 314.15; 314.17; 314.23(G); 314.28(B); 314.29; and 314.30

314.72 Construction and Installation Requirements

NEC Language

(A) **Corrosion Protection.** Boxes shall be made of material inherently resistant to corrosion or shall be suitably protected, both internally and externally, by enameling, galvanizing, plating, or other means.

(B) **Passing Through Partitions.** Suitable bushings, shields, or fittings having smooth, rounded edges shall be provided where conductors or cables pass through partitions and at other locations where necessary.

(C) **Complete Enclosure.** Boxes shall provide a complete enclosure for the contained conductors or cables.

Changed From NEC 2008

314.72(D) **Wiring Is Accessible:** This was revised to include conduit bodies and to clarify the conductors must be accessible without damaging any fixed part of the building or structure.

NEC Language

(D) **Wiring Is Accessible.** Boxes and conduit bodies shall be installed so that the conductors are accessible without removing any fixed part of the building or structure. Working space shall be provided in accordance with 110.34.

(E) **Suitable Covers.** Boxes shall be closed by suitable covers securely fastened in place. Underground box covers that weigh over 45 kg (100 lb) shall be considered meeting this requirement. Covers for boxes shall be permanently marked:

DANGER — HIGH VOLTAGE — KEEP OUT

The marking shall be on the outside of the box cover and shall be readily visible. Letters shall be block type and at least 13 mm (½ in.) in height.

(F) **Suitable for Expected Handling.** Boxes and their covers shall be capable of withstanding the handling to which they are likely to be subjected.

Article 320 — Armored Cable: Type AC

Articles 320 through 340 address specific types of cables. This helps to:

- Understand what's available for doing the work.
- Recognize cable types that have special NEC requirements.
- Avoid buying cable that can't be installed due to Code requirements that can't be met with that particular wiring method.

I. General

320.2 Definition

Changed From NEC 2008

320.2: This was editorially revised to more accurately describe the cable.

NEC Language

Armored Cable, Type AC. A fabricated assembly of insulated conductors in a flexible interlocked metallic armor. See 320.100.

II. Installation

320.23 In Accessible Attics

NEC Language

Type AC cables in accessible attics or roof spaces shall be installed as specified in 320.23(A) and (B).

Changed From NEC 2008

320.23(A) **Cables Run Across the Top of Floor Joists:** the Title was revised for consistency with 320.23(B).

NEC Language

(A) **Cables Run Across the Top of Floor Joists.** Where run across the top of floor joists, or within 2.1 m (7 ft) of the floor or floor joists across the face of rafters or studding, the cable shall be protected by substantial guard strips that are at least as high as the cable. Where this space is not accessible by permanent stairs or ladders, protection shall only be required within 1.8 m (6 ft) of the nearest edge of the scuttle hole or attic entrance.

(B) **Cable Installed Parallel to Framing Members.** Where the cable is installed parallel to the sides of rafters, studs, or ceiling or floor joists, neither guard strips nor running boards shall be required, and the installation shall also comply with 300.4(D).

320.80 Ampacity

NEC Language

The ampacity shall be determined in accordance with 310.15.

Changed From NEC 2008

320.80(A) Thermal Insulation: This was revised to clarify ampacity adjustment and correction.

NEC Language

(A) **Thermal Insulation.** Armored cable installed in thermal insulation shall have conductors rated at 90°C (194°F). The ampacity of cable installed in these applications shall not exceed that of a 60°C (140°F) rated conductor. The 90°C (194°F) rating shall be permitted to be used for ampacity adjustment and correction calculations; however, the ampacity shall not exceed that of a 60°C (140°F) rated conductor.

(B) **Cable Tray.** The ampacity of Type AC cable installed in cable tray shall be determined in accordance with 392.80(A).

322.12 Uses Not Permitted

NEC Language

Flat cable assemblies shall not be used as follows:

- (1) Where exposed to corrosive conditions, unless suitable for the application
- (2) In hoistways or on elevators or escalators

Changed From NEC 2008

322.12(3): This was revised to indicate that there may be other articles that permit the use of the wiring method in a hazardous (classified) location.

NEC Language

(3) In any hazardous (classified) location, except as specifically permitted by other articles in this Code

(4) Outdoors or in wet or damp locations unless identified for the use

328.10 Uses Permitted

NEC Language

Type MV cable shall be permitted for use on power systems rated up to and including 35,000 volts, nominal, as follows:

- (1) In wet or dry locations.
- (2) In raceways.

Changed From NEC 2008

328.10(3) and (6): This was revised by incorporating the exceptions into positive text.

NEC Language

(3) In cable trays, where identified for the use, in accordance with 392.10, 392.20(B), (C), and (D), 392.22(C), 392.30(B)(1), 392.46, 392.56, and 392.60. Type MV cable that has an overall metallic sheath or armor, complies with the requirements for Type MC cable, and is identified as "MV or MC" shall be permitted to be installed in cable trays in accordance with 392.10(B)(2).

(4) Direct buried in accordance with 300.50.

(5) In messenger-supported wiring in accordance with Part II of Article 396.

(6) As exposed runs in accordance with 300.37. Type MV cable that has an overall metallic sheath or armor, complies with the requirements for Type MC cable, and is identified as "MV or MC" shall be permitted to be installed as exposed runs of metal-clad cable in accordance with 300.37.

Informational Note: The "Uses Permitted" is not an all-inclusive list.

328.14 Installation**Changed From NEC 2008**

328.14: This was added to require qualified persons for installation, terminating, and testing.

NEC Language

Type MV cable shall be installed, terminated, and tested by qualified persons.

Changed From NEC 2008

328.14 Informational Note: Added Informational Note to refer to a standard for installing, terminating, and testing MV cable.

NEC Language

Informational Note: IEEE 576-2000, Recommended Practice for Installation, Termination, and Testing of Insulated Power Cables as Used in Industrial and Commercial Applications, includes installation information and testing criteria for MV cable.

330.10 Uses Permitted**NEC Language**

(A) **General Uses.** Type MC cable shall be permitted as follows:

- (1) For services, feeders, and branch circuits.
- (2) For power, lighting, control, and signal circuits.
- (3) Indoors or outdoors.
- (4) Exposed or concealed.

- (5) To be direct buried where identified for such use.
- (6) In cable tray where identified for such use.
- (7) In any raceway.
- (8) As aerial cable on a messenger.

Changed From NEC 2008

330.10(A)(9): This was revised to indicate there may be other articles that permit the use of the wiring method in a hazardous (classified) location.

NEC Language

- (9) In hazardous (classified) locations where specifically permitted by other articles in this Code.

332.10 Uses Permitted

NEC Language

Type MI cable shall be permitted as follows:

- (1) For services, feeders, and branch circuits
- (2) For power, lighting, control, and signal circuits
- (3) In dry, wet, or continuously moist locations
- (4) Indoors or outdoors
- (5) Where exposed or concealed
- (6) Where embedded in plaster, concrete, fill, or other masonry, whether above or below grade

Changed From NEC 2008

332.10(7): This was revised to indicate there may be other articles that permit the use of the wiring method in a hazardous (classified) location.

NEC Language

- (7) In hazardous (classified) locations where specifically permitted by other articles in this Code
- (8) Where exposed to oil and gasoline
- (9) Where exposed to corrosive conditions not deteriorating to its sheath
- (10) In underground runs where suitably protected against physical damage and corrosive conditions
- (11) In or attached to cable tray

Informational Note: The "Uses Permitted" is not an all-inclusive list.

- (10) In dry locations and embedded in plaster finish on brick or other masonry except in damp or wet locations.

(11) In wet locations where any of the following conditions are met:

- a. The metallic covering is impervious to moisture.
- b. A moisture-impervious jacket is provided under the metal covering.
- c. The insulated conductors under the metallic covering are listed for use in wet locations, and a corrosion-resistant jacket is provided over the metallic sheath.

334.10 Uses Permitted

Type NM, Type NMC, and Type NMS cables shall be permitted to be used in the following:

Changed From NEC 2008

334.10(1): This was revised to include attached and detached garages and their storage buildings.

New in this Code version are additional allowable uses of NM, or non-metallic sheathed cable.

Currently type NM cable can be used in one and two family dwellings for both exposed and concealed work in normally dry locations.

Conditions have been added to its uses that will now include “accessory structures” of one and two family dwellings. Presumably this will include detached garages, storage sheds, etc.

The Code is not clear on the full scope of accessory structures and will likely need to be clarified by the local inspector as to what this scope will be.

Type NM cable is also still rated for use inside air voids of masonry block or tile walls.

NEC Language

(1) One- and two-family dwellings and their attached or detached garages, and their storage buildings.

(2) Multifamily dwellings permitted to be of Types III, IV, and V construction except as prohibited in 334.12.

(3) Other structures permitted to be of Types III, IV, and V construction except as prohibited in 334.12. Cables shall be concealed within walls, floors, or ceilings that provide a thermal barrier of material that has at least a 15-minute finish rating as identified in listings of fire-rated assemblies.

Informational Note No. 1: Types of building construction and occupancy classifications are defined in NFPA 220-2009, Standard on Types of Building Construction, or the applicable building code, or both.

Informational Note No. 2: See Informative Annex E for determination of building types [NFPA 220, Table 3-1].

(4) Cable trays in structures permitted to be Types III, IV, or V where the cables are identified for the use.

Informational Note: See 310.15(A)(3) for temperature limitation of conductors.

Changed From NEC 2008

334.10(5): This was added to include the text formerly in the exception to 334.12(A).

NEC Language

(5) Types I and II construction where installed within raceways permitted to be installed in Types I and II construction.

(A) Type NM. Type NM cable shall be permitted as follows:

(1) For both exposed and concealed work in normally dry locations except as prohibited in 334.10(3)

(2) To be installed or fished in air voids in masonry block or tile walls

(B) Type NMC. Type NMC cable shall be permitted as follows:

(1) For both exposed and concealed work in dry, moist, damp, or corrosive locations, except as prohibited by 334.10(3)

(2) In outside and inside walls of masonry block or tile

(3) In a shallow chase in masonry, concrete, or adobe protected against nails or screws by a steel plate at least 1.59 mm (in.) thick and covered with plaster, adobe, or similar finish

(C) Type NMS. Type NMS cable shall be permitted as follows:

(1) For both exposed and concealed work in normally dry locations except as prohibited by 334.10(3)

(2) To be installed or fished in air voids in masonry block or tile walls

334.15 Exposed Work**NEC Language**

In exposed work, except as provided in 300.11(A), cable shall be installed as specified in 334.15(A) through (C).

(A) **To Follow Surface.** Cable shall closely follow the surface of the building finish or of running boards.

Changed From NEC 2008

334.15(B) **Protection from Physical Damage:** This was added a reference to RTRC-XW conduit to provide protection from physical damage.

NEC Language

(B) **Protection from Physical Damage.** Cable shall be protected from physical damage where necessary by rigid metal conduit, intermediate metal conduit, electrical metallic tubing, Schedule 80 PVC conduit, Type RTRC marked with the suffix -XW, or other approved means. Where passing through a floor, the cable shall be enclosed in rigid metal conduit, intermediate metal conduit, electrical metallic tubing, Schedule 80 PVC

conduit, Type RTRC marked with the suffix -XW, or other approved means extending at least 150 mm (6 in.) above the floor.

Type NMC cable installed in shallow chases or grooves in masonry, concrete, or adobe shall be protected in accordance with the requirements in 300.4(F) and covered with plaster, adobe, or similar finish.

334.80 Ampacity

Changed From NEC 2008

334.80: This was revised to clarify the use of ampacity adjustment and correction calculations.

NEC Language

The ampacity of Types NM, NMC, and NMS cable shall be determined in accordance with 310.15. The allowable ampacity shall not exceed that of a 60°C (140°F) rated conductor. The 90°C (194°F) rating shall be permitted to be used for ampacity adjustment and correction calculations, provided the final derated ampacity does not exceed that of a 60°C (140°F) rated conductor. The ampacity of Types NM, NMC, and NMS cable installed in cable tray shall be determined in accordance with 392.80(A).

Where more than two NM cables containing two or more current-carrying conductors are installed, without maintaining spacing between the cables, through the same opening in wood framing that is to be sealed with thermal insulation, caulk, or sealing foam, the allowable ampacity of each conductor shall be adjusted in accordance with Table 310.15(B)(3)(a) and the provisions of 310.15(A)(2), Exception, shall not apply.

Where more than two NM cables containing two or more current-carrying conductors are installed in contact with thermal insulation without maintaining spacing between cables, the allowable ampacity of each conductor shall be adjusted in accordance with Table 310.15(B)(3)(a).

336.12 Uses Not Permitted

NEC Language

Type TC tray cable shall not be installed or used as follows:

- (1) Installed where it will be exposed to physical damage

Changed From NEC 2008

336.12(2): This was revised to include a reference to 336.10(4) which permits Type TC cable to be supported outdoors on a messenger wire.

NEC Language

- (2) Installed outside a raceway or cable tray system, except as permitted in 336.10(4) and 336.10(7)
- (3) Used where exposed to direct rays of the sun, unless identified as sunlight resistant
- (4) Direct buried, unless identified for such use

338.10 Uses Permitted

(A) **Service-Entrance Conductors.** Service-entrance cable shall be permitted to be used as service-entrance conductors and shall be installed in accordance with 230.6, 230.7, and Parts II, III, and IV of Article 230.

(B) **Branch Circuits or Feeders.**

(1) **Grounded Conductor Insulated.** Type SE service-entrance cables shall be permitted in wiring systems where all of the circuit conductors of the cable are of the thermoset or thermoplastic type.

Changed From NEC 2008

338.10(B)(2) **Use of Uninsulated Conductor:** Editorial revision for clarity.

NEC Language

(2) **Use of Uninsulated Conductor.** Type SE service-entrance cable shall be permitted for use where the insulated conductors are used for circuit wiring and the uninsulated conductor is used only for equipment grounding purposes.

Changed From NEC 2008

338.10(B)(2) **Exception:** This was revised to limit the applicability to existing installations.

NEC Language

Exception: In existing installations, uninsulated conductors shall be permitted as a grounded conductor in accordance with 250.32 and 250.140, where the uninsulated grounded conductor of the cable originates in service equipment, and with 225.30 through 225.40.

(3) **Temperature Limitations.** Type SE service-entrance cable used to supply appliances shall not be subject to conductor temperatures in excess of the temperature specified for the type of insulation involved.

Changed From NEC 2008

338.10(B)(4): This was revised to exclude the requirements 334.80 and to specify the ampacity of SE cable installed in thermal insulation cannot exceed the 60°C temperature rating.

NEC Language

(4) **Installation Methods for Branch Circuits and Feeders.**

(a) **Interior Installations.** In addition to the provisions of this article, Type SE service-entrance cable used for interior wiring shall comply with the installation requirements of Part II of Article 334, excluding 334.80.

Where installed in thermal insulation, the ampacity shall be in accordance with the 60°C (140°F) conductor temperature rating. The maximum conductor temperature rating shall be permitted to be used for ampacity adjustment and correction purposes, if the final derated ampacity does not exceed that for a 60°C (140°F) rated conductor.

Informational Note No. 1: See 310.15(A)(3) for temperature limitation of conductors.

Changed From NEC 2008

338.10(B)(4)(a) **Informational Note 2:** This was added to refer to additional requirements for installation of main power feeders in dwelling units.

NEC Language

Informational Note No. 2: For the installation of main power feeder conductors in dwelling units refer to 310.15(B)(7).

(b) **Exterior Installations.** In addition to the provisions of this article, service-entrance cable used for feeders or branch circuits, where installed as exterior wiring, shall be installed in accordance with Part I of Article 225. The cable shall be supported in accordance with 334.30. Type USE cable installed as underground feeder and branch circuit cable shall comply with Part II of Article 340.

340.12 Uses Not Permitted**NEC Language**

Type UF cable shall not be used as follows:

- (1) As service-entrance cable
- (2) In commercial garages
- (3) In theaters and similar locations
- (4) In motion picture studios
- (5) In storage battery rooms
- (6) In hoistways or on elevators or escalators

Changed From NEC 2008

340.12(7): This was revised to indicate that there may be other articles that permit the use of the wiring method in a hazardous (classified) location.

NEC Language

- (7) In hazardous (classified) locations, except as specifically permitted by other articles in this Code
- (8) Embedded in poured cement, concrete, or aggregate, except where embedded in plaster as nonheating leads where permitted in 424.43
- (9) Where exposed to direct rays of the sun, unless identified as sunlight resistant
- (10) Where subject to physical damage
- (11) As overhead cable, except where installed as messenger-supported wiring in accordance with Part II of Article 396

342.30 Securing and Supporting**Changed From NEC 2008**

342.30(C): Deleted rules describing the conditions where raceways can be installed unsupported.

NEC Language

IMC shall be installed as a complete system in accordance with 300.18 and shall be securely fastened in place and supported in accordance with 342.30(A) and (B) or permitted to be unsupported in accordance with 342.30(C).

Changed From NEC 2008

342.30(A) **Use of Uninsulated Conductor:** This was revised into a list format for usability.

NEC Language

(A) **Securely Fastened.** IMC shall be secured in accordance with one of the following:

- (1) IMC shall be securely fastened within 900 mm (3 ft) of each outlet box, junction box, device box, cabinet, conduit body, or other conduit termination.
- (2) Where structural members do not readily permit fastening within 900 mm (3 ft), fastening shall be permitted to be increased to a distance of 1.5 m (5 ft).
- (3) Where approved, conduit shall not be required to be securely fastened within 900 mm (3 ft) of the service head for above-the-roof termination of a mast.

Intermediate metal conduit (IMC) is required by 342.30(A) to be securely fastened at least every 10 ft, as illustrated in Exhibit 342.1. Fastening is also required within 3 ft of outlet boxes, junction boxes, cabinets, and conduit bodies. However, where structural support members do not permit fastening within 3 ft, the support may be located up to 5 ft away. This section was reformatted for the 2011 Code. However, there are no technical changes to the requirements.

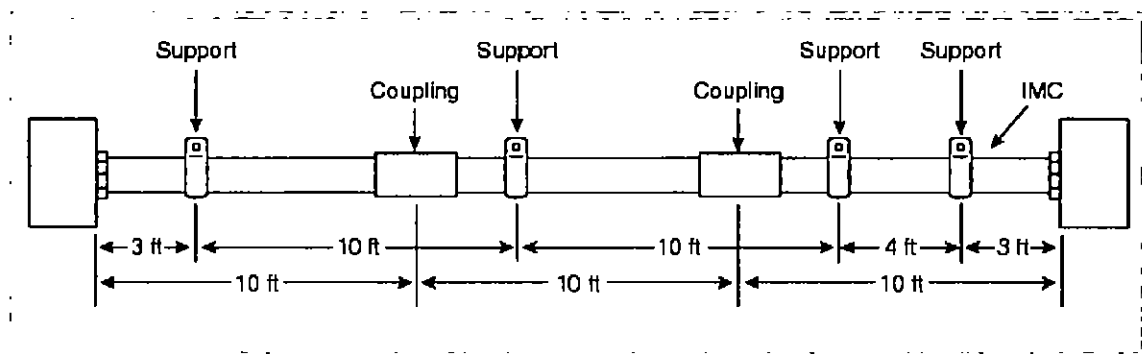

Exhibit 342.1 Minimum fastening requirements for intermediate metal conduit according to 342.30(A).

(B) **Supports.** IMC shall be supported in accordance with one of the following:

- (1) Conduit shall be supported at intervals not exceeding 3 m (10 ft).
- (2) The distance between supports for straight runs of conduit shall be permitted in accordance with Table 344.30(B)(2), provided the conduit is made up with threaded couplings and such supports prevent transmission of stresses to termination where conduit is deflected between supports.

(3) Exposed vertical risers from industrial machinery or fixed equipment shall be permitted to be supported at intervals not exceeding 6 m (20 ft) if the conduit is made up with threaded couplings, the conduit is supported and securely fastened at the top and bottom of the riser, and no other means of intermediate support is readily available.

(4) Horizontal runs of IMC supported by openings through framing members at intervals not exceeding 3 m (10 ft) and securely fastened within 900 mm (3 ft) of termination points shall be permitted.

Section 342.30(B)(4) permits lengths of IMC to be supported (but not necessarily secured) by framing members at 10-ft intervals, provided the IMC is secured and supported at least 3 ft from the box or enclosure. Exhibit 342.2 illustrates an installation where the IMC is installed through the bar joists.

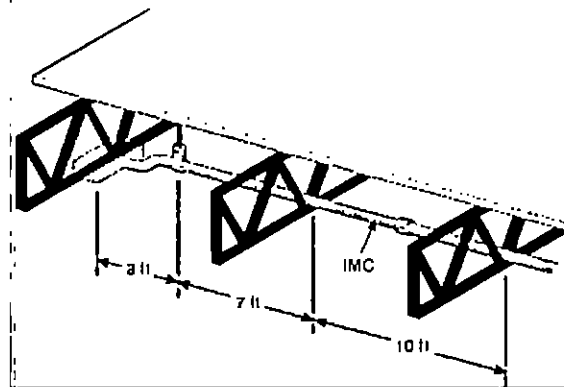

NEC 2011

Exhibit 342.2 An example of intermediate metal conduit supported by framing members and securely fastened at the 3-ft distance from the box, as required by 342.30(B)(4).

342.46 Bushings

Changed From NEC 2008

342.46: This was editorially revised to clarify that the box, fitting, or enclosure must be designed to provide the necessary protection.

NEC Language

Where a conduit enters a box, fitting, or other enclosure, a bushing shall be provided to protect the wires from abrasion unless the box, fitting, or enclosure is designed to provide such protection.

Informational Note: See 300.4(G) for the protection of conductors 4 AWG and larger at bushings.

344.30 Securing and Supporting

Changed From NEC 2008

344.30(C): Deleted rules describing the conditions where raceways can be installed unsupported.

NEC Language

RMC shall be installed as a complete system in accordance with 300.18 and shall be securely fastened in place and supported in accordance with 344.30(A) and (B).

(A) **Securely Fastened.** RMC shall be securely fastened within 900 mm (3 ft) of each outlet box, junction box, device box, cabinet, conduit body, or other conduit termination. Fastening shall be permitted to be increased to a distance of 1.5 m (5 ft) where structural members do not readily permit fastening within 900 mm (3 ft). Where approved, conduit shall not be required to be securely fastened within 900 mm (3 ft) of the service head for above-the-roof termination of a mast.

(B) **Supports.** RMC shall be supported in accordance with one of the following:

(1) Conduit shall be supported at intervals not exceeding 3 m (10 ft).

(2) The distance between supports for straight runs of conduit shall be permitted in accordance with Table 344.30(B)(2), provided the conduit is made up with threaded couplings and such supports prevent transmission of stresses to termination where conduit is deflected between supports.

(3) Exposed vertical risers from industrial machinery or fixed equipment shall be permitted to be supported at intervals not exceeding 6 m (20 ft) if the conduit is made up with threaded couplings, the conduit is supported and securely fastened at the top and bottom of the riser, and no other means of intermediate support is readily available.

(4) Horizontal runs of RMC supported by openings through framing members at intervals not exceeding 3 m (10 ft) and securely fastened within 900 mm (3 ft) of termination points shall be permitted.

Table 344.30(B)(2) Supports for Rigid Metal Conduit

Conduit Size		Maximum Distance Between Rigid Metal Conduit Supports	
		m	ft
Metric Designator	Trade Size		
16-21	½-¾	3.0	10
27	1	3.7	12
35-41	1¼-1½	4.3	14
53-63	2-2½	4.9	16
78 and larger	3 and larger	6.1	20

NEC 2011

344.46 Bushings

Changed From NEC 2008

344.46: This was editorially revised to clarify the box, fitting, or enclosure must be designed to provide the necessary protection.

NEC Language

Where a conduit enters a box, fitting, or other enclosure, a bushing shall be provided to protect the wires from abrasion unless the box, fitting, or enclosure is designed to provide such protection.

Informational Note: See 300.4(G) for the protection of conductors sizes 4 AWG and larger at bushings.

348.30 Securing and Supporting

FMC shall be securely fastened in place and supported in accordance with 348.30(A) and (B).

(A) **Securely Fastened.** FMC shall be securely fastened in place by an approved means within 300 mm (12 in.) of each box, cabinet, conduit body, or other conduit termination and shall be supported and secured at intervals not to exceed 1.4 m (4½ ft).

Exception No. 1: Where FMC is fished between access points through concealed spaces in finished buildings or structures and supporting is impracticable.

Changed From NEC 2008

348.30(A) Exception 2: This was revised to describe where the measurements are made.

NEC Language

Exception No. 2: Where flexibility is necessary after installation, lengths from the last point where the raceway is securely fastened shall not exceed the following:

- (1) 900 mm (3 ft) for metric designators 16 through 35 (trade sizes ½ through 1¼)
- (2) 1200 mm (4 ft) for metric designators 41 through 53 (trade sizes 1½ through 2)
- (3) 1500 mm (5 ft) for metric designators 63 (trade size 2½) and larger

Exception No. 3: Lengths not exceeding 1.8 m (6 ft) from a luminaire terminal connection for tap connections to luminaires as permitted in 410.117(C).

Exception No. 4: Lengths not exceeding 1.8 m (6 ft) from the last point where the raceway is securely fastened for connections within an accessible ceiling to luminaire(s) or other equipment.

(B) **Supports.** Horizontal runs of FMC supported by openings through framing members at intervals not greater than 1.4 m (4½ ft) and securely fastened within 300 mm (12 in.) of termination points shall be permitted.

348.42 Couplings and Connectors

Changed From NEC 2008

Angle connectors for flexible metal conduit cannot be installed where the angle connector itself will be concealed.

NEC Language

Text deleted from 2008 NEC: Angle connectors shall not be used for concealed raceway installations.

Text in 2011 NEC: Angle connectors shall not be concealed.

348.60 Grounding and Bonding

Changed From NEC 2008

348.60: This was revised to more specifically describe the conditions where flexibility is necessary.

NEC Language

If used to connect equipment where flexibility is necessary to minimize the transmission of vibration from equipment or to provide flexibility for equipment that requires movement after installation, an equipment grounding conductor shall be installed.

Where flexibility is not required after installation, FMC shall be permitted to be used as an equipment grounding conductor when installed in accordance with 250.118(5).

Where required or installed, equipment grounding conductors shall be installed in accordance with 250.134(B).

Where required or installed, equipment bonding jumpers shall be installed in accordance with 250.102.

350.30 Securing and Supporting

NEC Language

LFMC shall be securely fastened in place and supported in accordance with 350.30(A) and (B).

(A) **Securely Fastened.** LFMC shall be securely fastened in place by an approved means within 300 mm (12 in.) of each box, cabinet, conduit body, or other conduit termination and shall be supported and secured at intervals not to exceed 1.4 m (4½ ft).

Exception No. 1: Where LFMC is fished between access points through concealed spaces in finished buildings or structures and supporting is impractical.

Changed From NEC 2008

350.30(A) **Exception No. 2:** This was revised to describe where the measurements are made.

NEC Language

Exception No. 2: Where flexibility is necessary after installation, lengths from the last point where the raceway is securely fastened shall not exceed the following:

- (1) 900 mm (3 ft) for metric designators 16 through 35 (trade sizes ½ through 1¼)
- (2) 1200 mm (4 ft) for metric designators 41 through 53 (trade sizes 1½ through 2)
- (3) 1500 mm (5 ft) for metric designators 63 (trade size 2½) and larger

Exception No. 3: Lengths not exceeding 1.8 m (6 ft) from a luminaire terminal connection for tap conductors to luminaires, as permitted in 410.117(C).

Exception No. 4: Lengths not exceeding 1.8 m (6 ft) from the last point where the raceway is securely fastened for connections within an accessible ceiling to luminaire(s) or other equipment.

(B) Supports. Horizontal runs of LFMC supported by openings through framing members at intervals not greater than 1.4 m (4½ ft) and securely fastened within 300 mm (12 in.) of termination points shall be permitted.

350.42 Couplings and Connectors**Changed From NEC 2008**

350.42: This was revised to clarify that an angle connector can be used with a concealed raceway system where the angle connector is not concealed.

NEC Language

Angle connectors shall not be concealed.

350.60 Grounding and Bonding**Changed From NEC 2008**

350.60: This was revised to describe the conditions where flexibility is necessary.

NEC Language

If used to connect equipment where flexibility is necessary to minimize the transmission of vibration from equipment or to provide flexibility for equipment that requires movement after installation, an equipment grounding conductor shall be installed.

Where flexibility is not required after installation, LFMC shall be permitted to be used as an equipment grounding conductor when installed in accordance with 250.118(6).

Where required or installed, equipment grounding conductors shall be installed in accordance with 250.134(B).

Where required or installed, equipment bonding jumpers shall be installed in accordance with 250.102.

Informational Note: See 501.30(B), 502.30(B), 503.30(B), 505.25(B), and 506.25(B) for types of equipment grounding conductors.

352.10 Uses Permitted**NEC Language**

The use of PVC conduit shall be permitted in accordance with 352.10(A) through (H).

Informational Note: Extreme cold may cause some nonmetallic conduits to become brittle and, therefore, more susceptible to damage from physical contact.

- (A) **Concealed.** PVC conduit shall be permitted in walls, floors, and ceilings.
- (B) **Corrosive Influences.** PVC conduit shall be permitted in locations subject to severe corrosive influences as covered in 300.6 and where subject to chemicals for which the materials are specifically approved.
- (C) **Cinders.** PVC conduit shall be permitted in cinder fill.
- (D) **Wet Locations.** PVC conduit shall be permitted in portions of dairies, laundries, canneries, or other wet locations, and in locations where walls are frequently washed, the entire conduit system, including boxes and fittings used therewith, shall be installed and equipped so as to prevent water from entering the conduit. All supports, bolts, straps, screws, and so forth, shall be of corrosion-resistant materials or be protected against corrosion by approved corrosion-resistant materials.
- (E) **Dry and Damp Locations.** PVC conduit shall be permitted for use in dry and damp locations not prohibited by 352.12.
- (F) **Exposed.** PVC conduit shall be permitted for exposed work. PVC conduit used exposed in areas of physical damage shall be identified for the use.

Informational Note: PVC Conduit, Type Schedule 80, is identified for areas of physical damage.

Changed From NEC 2008

352.10(G) **Underground Installations:** This was revised by removing the terms "nonhomogenous and homogenous."

NEC Language

- (G) **Underground Installations.** For underground installations, PVC shall be permitted for direct burial and underground encased in concrete. See 300.5 and 300.50.
- (H) **Support of Conduit Bodies.** PVC conduit shall be permitted to support nonmetallic conduit bodies not larger than the largest trade size of an entering raceway. These conduit bodies shall not support luminaires or other equipment and shall not contain devices other than splicing devices as permitted by 110.14(B) and 314.16(C)(2).

Changed From NEC 2008

352.10(I) **Insulation Temperature Limitations:** This was added to incorporate text formerly in the 352.12(E) and the exception.

NEC Language

- (I) **Insulation Temperature Limitations.** Conductors or cables rated at a temperature higher than the listed temperature rating of PVC conduit shall be permitted to be installed in PVC conduit, provided the conductors or cables are not operated at a temperature higher than the listed temperature rating of the PVC conduit.

352.30 Securing and Supporting

Changed From NEC 2008

352.30(C): Deleted the rules describing the conditions where raceways can be installed unsupported.

NEC Language

PVC conduit shall be installed as a complete system as provided in 300.18 and shall be fastened so that movement from thermal expansion or contraction is permitted. PVC conduit shall be securely fastened and supported in accordance with 352.30(A) and (B).

(A) **Securely Fastened.** PVC conduit shall be securely fastened within 900 mm (3 ft) of each outlet box, junction box, device box, conduit body, or other conduit termination. Conduit listed for securing at other than 900 mm (3 ft) shall be permitted to be installed in accordance with the listing.

(B) **Supports.** PVC conduit shall be supported as required in Table 352.30. Conduit listed for support at spacings other than as shown in Table 352.30 shall be permitted to be installed in accordance with the listing. Horizontal runs of PVC conduit supported by openings through framing members at intervals not exceeding those in Table 352.30 and securely fastened within 900 mm (3 ft) of termination points shall be permitted.

Conduit Size		Maximum Spacing Between Supports	
		mm or m	ft
Metric Designator	Trade Size		
16–27	½–1	900 mm	3
35–53	1¼–2	1.5 m	5
63–78	2½–3	1.8 m	6
91–129	3½–5	2.1 m	7
155	6	2.5 m	8

NEC 2011

353.10 Uses Permitted [High Density Polyethylene Conduit (Type HDPE)]

NEC Language

The use of HDPE conduit shall be permitted under the following conditions:

- (1) In discrete lengths or in continuous lengths from a reel
- (2) In locations subject to severe corrosive influences as covered in 300.6 and where subject to chemicals for which the conduit is listed
- (3) In cinder fill
- (4) In direct burial installations in earth or concrete

Informational Note to (4): Refer to 300.5 and 300.50 for underground installations.

(5) Above ground, except as prohibited in 353.12, where encased in not less than 50 mm (2 in.) of concrete.

Changed From NEC 2008

353.10(6): This was added to incorporate text formerly in the 353.12(A)(5) and the exception.

NEC Language

(6) Conductors or cables rated at a temperature higher than the listed temperature rating of HDPE conduit shall be permitted to be installed in HDPE conduit, provided the conductors or cables are not operated at a temperature higher than the listed temperature rating of the HDPE conduit.

353.24 Bends — How Made

Changed From NEC 2008

353.24: This was revised by adding a new second sentence to specify that the bending radius of trade size 5 and 6 conduits must comply with the manufacturer's instructions.

NEC Language

Bends shall be so made that the conduit will not be damaged and the internal diameter of the conduit will not be effectively reduced. Bends shall be permitted to be made manually without auxiliary equipment, and the radius of the curve to the centerline of such bends shall not be less than shown in Table 354.24. For conduits of metric designators 129 and 155 (trade sizes 5 and 6) the allowable radii of bends shall be in accordance with specifications provided by the manufacturer.

355.10 Uses Permitted

NEC Language

The use of RTRC shall be permitted in accordance with 355.10(A) through (I).

(A) **Concealed.** RTRC shall be permitted in walls, floors, and ceilings.

(B) **Corrosive Influences.** RTRC shall be permitted in locations subject to severe corrosive influences as covered in 300.6 and where subject to chemicals for which the materials are specifically approved.

(C) **Cinders.** RTRC shall be permitted in cinder fill.

(D) **Wet Locations.** RTRC shall be permitted in portions of dairies, laundries, canneries, or other wet locations, and in locations where walls are frequently washed, the entire conduit system, including boxes and fittings used therewith, shall be installed and equipped so as to prevent water from entering the conduit. All supports, bolts, straps, screws, and so forth, shall be of corrosion-resistant materials or be protected against corrosion by approved corrosion-resistant materials.

(E) **Dry and Damp Locations.** RTRC shall be permitted for use in dry and damp locations not prohibited by 355.12.

(F) **Exposed.** RTRC shall be permitted for exposed work if identified for such use.

Changed From NEC 2008

355.10(F) **Informational Note:** This was added to indicate that RTRC marked with “XW” is identified for areas of physical damage.

NEC Language

Informational Note: RTRC, Type XW, is identified for areas of physical damage.

(G) **Underground Installations.** For underground installations, see 300.5 and 300.50.

(H) **Support of Conduit Bodies.** RTRC shall be permitted to support nonmetallic conduit bodies not larger than the largest trade size of an entering raceway. These conduit bodies shall not support luminaires or other equipment and shall not contain devices other than splicing devices as permitted by 110.14(B) and 314.16(C)(2).

Changed From NEC 2008

355.10(I) **Insulation Temperature Limitations:** This was added to incorporate text formerly provided in the 355.12(E) and the exception.

NEC Language

(I) **Insulation Temperature Limitations.** Conductors or cables rated at a temperature higher than the listed temperature rating of RTRC conduit shall be permitted to be installed in RTRC conduit, if the conductors or cables are not operated at a temperature higher than the listed temperature rating of the RTRC conduit.

355.30 Securing and Supporting

Changed From NEC 2008

355.30(C): Here, the NEC deleted the rules describing the conditions where raceways can be installed unsupported.

NEC Language

RTRC shall be installed as a complete system in accordance with 300.18 and shall be securely fastened in place and supported in accordance with 355.30(A) and (B).

(A) **Securely Fastened.** RTRC shall be securely fastened within 900 mm (3 ft) of each outlet box, junction box, device box, conduit body, or other conduit termination. Conduit listed for securing at other than 900 mm (3 ft) shall be permitted to be installed in accordance with the listing.

(B) **Supports.** RTRC shall be supported as required in Table 355.30. Conduit listed for support at spacing other than as shown in Table 355.30 shall be permitted to be installed in accordance with the listing. Horizontal runs of RTRC supported by openings through framing members at intervals not exceeding those in Table 355.30 and securely fastened within 900 mm (3 ft) of termination points shall be permitted.

Conduit Size		Maximum Spacing Between Supports	
Metric Designator	Trade Size	mm or m	ft
16-27	½-1	900 mm	3
35-53	1¼-2	1.5 m	5
63-78	2½-3	1.8 m	6
91-129	3½-5	2.1 m	7
155	6	2.5 m	8

NEC 2011

358.10 Uses Permitted**NEC Language**

(A) **Exposed and Concealed.** The use of EMT shall be permitted for both exposed and concealed work.

Changed From NEC 2008

358.10(B) **Corrosion Protection:** This was revised to clarify that suitability must be determined by the authority having jurisdiction.

NEC Language

(B) **Corrosion Protection.** Ferrous or nonferrous EMT, elbows, couplings, and fittings shall be permitted to be installed in concrete, in direct contact with the earth, or in areas subject to severe corrosive influences where protected by corrosion protection and approved as suitable for the condition.

(C) **Wet Locations.** All supports, bolts, straps, screws, and so forth shall be of corrosion-resistant materials or protected against corrosion by corrosion-resistant materials.

Informational Note: See 300.6 for protection against corrosion.

358.30 Securing and Supporting**Changed From NEC 2008**

358.30(C): The NEC deleted the rules describing the conditions where raceways can be installed unsupported.

NEC Language

EMT shall be installed as a complete system in accordance with 300.18 and shall be securely fastened in place and supported in accordance with 358.30(A) and (B).

(A) **Securely Fastened.** EMT shall be securely fastened in place at least every 3 m (10 ft). In addition, each EMT run between termination points shall be securely fastened

within 900 mm (3 ft) of each outlet box, junction box, device box, cabinet, conduit body, or other tubing termination.

Exception No. 1: Fastening of unbroken lengths shall be permitted to be increased to a distance of 1.5 m (5 ft) where structural members do not readily permit fastening within 900 mm (3 ft).

Exception No. 2: For concealed work in finished buildings or prefinished wall panels where such securing is impracticable, unbroken lengths (without coupling) of EMT shall be permitted to be fished.

(B) **Supports.** Horizontal runs of EMT supported by openings through framing members at intervals not greater than 3 m (10 ft) and securely fastened within 900 mm (3 ft) of termination points shall be permitted.

362.10 Uses Permitted

NEC Language

For the purpose of this article, the first floor of a building shall be that floor that has 50 percent or more of the exterior wall surface area level with or above finished grade. One additional level that is the first level and not designed for human habitation and used only for vehicle parking, storage, or similar use shall be permitted. The use of ENT and fittings shall be permitted in the following:

(1) In any building not exceeding three floors above grade as follows:

- a. For exposed work, where not prohibited by 362.12
- b. Concealed within walls, floors, and ceilings

(2) In any building exceeding three floors above grade, ENT shall be concealed within walls, floors, and ceilings where the walls, floors, and ceilings provide a thermal barrier of material that has at least a 15-minute finish rating as identified in listings of fire-rated assemblies. The 15-minute-finish-rated thermal barrier shall be permitted to be used for combustible or noncombustible walls, floors, and ceilings.

Exception to (2): Where a fire sprinkler system(s) is installed in accordance with NFPA 13-2010, Standard for the Installation of Sprinkler Systems, on all floors, ENT shall be permitted to be used within walls, floors, and ceilings, exposed or concealed, in buildings exceeding three floors abovegrade.

Informational Note: A finish rating is established for assemblies containing combustible (wood) supports. The finish rating is defined as the time at which the wood stud or wood joist reaches an average temperature rise of 121°C (250°F) or an individual temperature of 163°C (325°F) as measured on the plane of the wood nearest the fire. A finish rating is not intended to represent a rating for a membrane ceiling.

(3) In locations subject to severe corrosive influences as covered in 300.6 and where subject to chemicals for which the materials are specifically approved.

(4) In concealed, dry, and damp locations not prohibited by 362.12.

(5) Above suspended ceilings where the suspended ceilings provide a thermal barrier of material that has at least a 15-minute finish rating as identified in listings of fire-rated assemblies, except as permitted in 362.10(1)(a).

Exception to (5): ENT shall be permitted to be used above suspended ceilings in buildings exceeding three floors above grade where the building is protected throughout by a fire sprinkler

system installed in accordance with NFPA 13-2010, Standard for the Installation of Sprinkler Systems.

- (6) Encased in poured concrete, or embedded in a concrete slab on grade where ENT is placed on sand or approved screenings, provided fittings identified for this purpose are used for connections.
- (7) For wet locations indoors as permitted in this section or in a concrete slab on or belowgrade, with fittings listed for the purpose.
- (8) Metric designator 16 through 27 (trade size ½ through 1) as listed manufactured prewired assembly.

Informational Note: Extreme cold may cause some types of nonmetallic conduits to become brittle and therefore more susceptible to damage from physical contact.

Changed From NEC 2008

362.10(9): This was added to incorporate text formerly provided in the 362.12(4) and the exception.

NEC Language

- (9) Conductors or cables rated at a temperature higher than the listed temperature rating of ENT shall be permitted to be installed in ENT, if the conductors or cables are not operated at a temperature higher than the listed temperature rating of the ENT.

362.12 Uses Not Permitted

ENT shall not be used in the following:

- (1) In any hazardous (classified) location, except as permitted by other articles in this Code
- (2) For the support of luminaires and other equipment
- (3) Where subject to ambient temperatures in excess of 50°C (122°F) unless listed otherwise

Changed From NEC 2008

362.12(4) and Exception: Deleted: For conductors or cables operating at a temperature higher than the ENT listed temperature rating.

NEC Language

- (4) For direct earth burial

Exception to (4): Conductors or cables rated at a temperature higher than the ENT listed temperature rating shall be permitted to be installed in ENT, provided they are not operated at a temperature higher than the ENT listed temperature rating.

- (5) Where the voltage is over 600 volts
- (6) In exposed locations, except as permitted by 362.10(1), 362.10(5), and 362.10(7)
- (7) In theaters and similar locations, except as provided in 518.4 and 520.5
- (8) Where exposed to the direct rays of the sun, unless identified as sunlight resistant

(9) Where subject to physical damage

366.22 Number of Conductors

Changed From NEC 2008

366.22(A) Sheet Metal Auxiliary Gutters: This was revised to specify adjustment factors must be applied when the number of current-carrying conductors exceeds 30.

NEC Language

(A) **Sheet Metal Auxiliary Gutters.** The sum of the cross-sectional areas of all contained conductors at any cross section of a sheet metal auxiliary gutter shall not exceed 20 percent of the interior cross-sectional area of the sheet metal auxiliary gutter. The adjustment factors in 310.15(B)(3)(a) shall be applied only where the number of current-carrying conductors, including neutral conductors classified as current-carrying under the provisions of 310.15(B)(5), exceeds 30. Conductors for signaling circuits or controller conductors between a motor and its starter and used only for starting duty shall not be considered as current-carrying conductors.

(B) **Nonmetallic Auxiliary Gutters.** The sum of cross-sectional areas of all contained conductors at any cross section of the nonmetallic auxiliary gutter shall not exceed 20 percent of the interior cross-sectional area of the nonmetallic auxiliary gutter.

368.10 Uses Permitted (Busways)

NEC Language

Busways shall be permitted to be installed where they are located in accordance with 368.10(A) through (C).

(A) **Exposed.** Busways shall be permitted to be located in the open where visible, except as permitted in 368.10(C).

Changed From NEC 2008

368.10(B) Behind Access Panels: This title was revised to indicate that it applies to installations behind access panels.

NEC Language

(B) **Behind Access Panels.** Busways shall be permitted to be installed behind access panels, provided the busways are totally enclosed, of nonventilating-type construction, and installed so that the joints between sections and at fittings are accessible for maintenance purposes. Where installed behind access panels, means of access shall be provided, and either of the following conditions shall be met:

(1) The space behind the access panels shall not be used for air-handling purposes.

(2) Where the space behind the access panels is used for environmental air, other than ducts and plenums, there shall be no provisions for plug-in connections, and the conductors shall be insulated.

(C) **Through Walls and Floors.** Busways shall be permitted to be installed through walls or floors in accordance with (C)(1) and (C)(2).

- (1) **Walls.** Unbroken lengths of busway shall be permitted to be extended through dry walls.
- (2) **Floors.** Floor penetrations shall comply with (a) and (b):

(a) Busways shall be permitted to be extended vertically through dry floors if totally enclosed (unventilated) where passing through and for a minimum distance of 1.8 m (6 ft) above the floor to provide adequate protection from physical damage.

(b) In other than industrial establishments, where a vertical riser penetrates two or more dry floors, a minimum 100-mm (4-in.) high curb shall be installed around all floor openings for riser busways to prevent liquids from entering the opening. The curb shall be installed within 300 mm (12 in.) of the floor opening. Electrical equipment shall be located so that it will not be damaged by liquids that are retained by the curb.

Informational Note: See 300.21 for information concerning the spread of fire or products of combustion.

Article 372 — Cellular Concrete Floor Raceways

This article covers cellular concrete floor raceways, the hollow spaces in floors constructed of precast cellular concrete slabs, together with suitable metal fittings designed to provide access to the floor cells.

372.12 Splices and Taps

Changed From NEC 2008

372.12: This was revised to incorporate the *Informational Note* into the requirements.

NEC Language

Splices and taps shall be made only in header access units or junction boxes. A continuous unbroken conductor connecting the individual outlets is not a splice or tap.

Article 376 — Metal Wireways

This article covers the use, installation, and construction specifications for metal wireways and associated fittings.

Wireways are sheet-metal enclosures equipped with hinged or removable covers and are manufactured in 1-ft to 10-ft lengths and various widths and depths. Couplings, elbows, end plates, and accessories such as T and X fittings are available. Unlike auxiliary gutters, which are not permitted to extend more than 30 ft from the equipment they supplement, wireways may be run throughout an entire area.

II. Installation

376.10 Uses Permitted

Changed From NEC 2008

376.10: Editorial revision for usability.

NEC Language

The use of metal wireways shall be permitted as follows:

- (1) For exposed work.
- (2) In any hazardous (classified) location, as permitted by other articles in this Code.
- (3) In wet locations where wireways are listed for the purpose.
- (4) In concealed spaces as an extension that passes transversely through walls, if the length passing through the wall is unbroken. Access to the conductors shall be maintained on both sides of the wall.

Article 380 — Multi Outlet Assembly

This article covers the use and installation requirements for multi outlet assemblies.

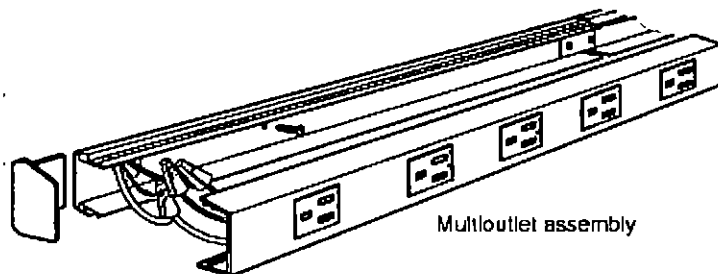

Multioutlet assembly

NEC 2011

Multi outlet assemblies are metal or nonmetallic raceways that are usually surface mounted and designed to contain branch-circuit conductors and receptacles. Receptacles may be spaced at desired intervals and may be assembled at the factory or in the field.

Changed From NEC 2008

380: This Article was renumbered for consistency with the other Chapter 3 articles.

II. Installation

380.23 Insulated Conductors (Multioutlet Assembly).

Changed From NEC 2008

The NEC added a new section to address *field-assembled multioutlet assemblies* and the installation of insulated conductors or cables.

NEC Language

For field assembled multioutlet assemblies, insulated conductors shall comply with 380.23(A) and (B).

(A) Deflected Insulated Conductors. Where insulated conductors are deflected within a multioutlet assembly, either at the ends or where conduits, fittings, or other raceways or cables enter or leave the multioutlet assembly, or where the direction of the multioutlet assembly is deflected greater than 30 degrees, dimensions corresponding to one wire per terminal in Table 312.6(A) shall apply.

(B) Multioutlet Assemblies Used as Pull Boxes. Where insulated conductors 4 AWG or larger are pulled through a multioutlet assembly, the distance between raceway and cable entries enclosing the same conductor shall not be less than that required by 314.28(A)(1) for straight pulls and 314.28(A)(2) for angle pulls. When transposing cable size into raceway size, the minimum metric designator (trade size) raceway required for the number and size of conductors in the cable shall be used.

This section was added for the 2011 Code. It provides safeguards to prevent overfill with a limitation of the number of conductors that can be installed in multioutlet assemblies. For deflected insulated conductors, dimensions corresponding to the minimum width of wiring gutters must be maintained.

Where a multioutlet assembly is used as a pull box for insulated conductors of 4 AWG or larger, the distance between the raceway and the cable entries enclosing the conductor must not be less than eight times the trade size or metric designator of the raceway for straight pulls. For angle pulls, the distance must be six times the trade size or metric designator of the raceway.

Article 390 — Underfloor Raceways

This article covers the use and installation requirements for under floor raceways.

An under floor raceway is a practical means of bringing light, power, and signal and communications systems to desks, work benches, or tables that are not located adjacent to wall space. This wiring method offers flexibility in layout where used with movable partitions and is commonly used in large retail stores and office buildings to supply power at any desired location.

Under floor raceways are permitted beneath the surface of concrete, wood, or other flooring material. The wiring method between cabinets, raceway junction boxes, and outlet boxes may be rigid metal conduit, intermediate metal conduit, rigid PVC conduit, liquidtight flexible nonmetallic conduit, electrical nonmetallic tubing, or electrical metallic tubing. Flexible metal conduit may be used where not installed in concrete.

390.2 Definition***Changed From NEC 2008***

390.2: Added a new definition for **Underfloor Raceway**.

NEC Language

Underfloor Raceway. A raceway and associated components designed and intended for installation beneath or flush with the surface of a floor for the installation of cables and electrical conductors.

Article 392 — Cable Trays

This article covers cable tray systems, including ladder, ventilated trough, ventilated channel, solid bottom, and other similar structures.

Cable trays are **mechanical support systems**. Cable trays are not **raceways**. See the definition of raceway in Article 100.

Cable tray installations are typically an industrial-type wiring method. However, they are sometimes installed in commercial facilities as a wire-and-cable management system for telecommunications/data installations and for feeder and branch-circuit wiring. The illustration below is one example of a UL-classified wire mesh-type cable tray used in an accessible underfloor application for MC cable distribution.

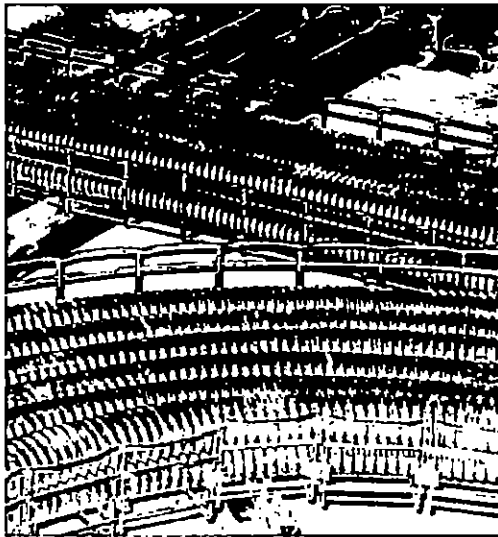

CABLOFIL® Legrand

MC cable distribution in a data center installed underfloor application

392: This Article was reorganized to include changes in headings and numbering scheme to comply with the NEC Manual of Style and for consistency with other Chapter 3 articles.

Please see your copy of NEC 2011 for the complete text.

II. Installation

392.18 Cable Tray Installation.

NEC Language

(A) **Complete System.** Cable trays shall be installed as a complete system. Field bends or modifications shall be so made that the electrical continuity of the cable tray system and support for the cables is maintained. Cable tray systems shall be permitted to have

mechanically discontinuous segments between cable tray runs or between cable tray runs and equipment.

Runs of cable tray are not required by 392.18(A) to be totally mechanically continuous from the equipment source to the equipment termination. Breaks in the mechanical continuity of cable tray systems are permitted and often occur at tees, crossovers, elevation changes, or firestops, or for thermal contraction and expansion. Also, cable tray systems are not required to be mechanically connected to the equipment they serve.

(B) Completed Before Installation. Each run of cable tray shall be completed before the installation of cables.

(C) Covers. In portions of runs where additional protection is required, covers or enclosures providing the required protection shall be of a material that is compatible with the cable tray.

(D) Through Partitions and Walls. Cable trays shall be permitted to extend transversely through partitions and walls or vertically through platforms and floors in wet or dry locations where the installations, complete with installed cables, are made in accordance with the requirements of 300.21.

(E) Exposed and Accessible. Cable trays shall be exposed and accessible, except as permitted by 392.10(D).

(F) Adequate Access. Sufficient space shall be provided and maintained about cable trays to permit adequate access for installing and maintaining the cables.

(G) Raceways, Cables, Boxes, and Conduit Bodies Supported from Cable Tray Systems. In industrial facilities where conditions of maintenance and supervision ensure that only qualified persons service the installation and where the cable tray systems are designed and installed to support the load, such systems shall be permitted to support raceways and cables, and boxes and conduit bodies covered in 314.1. For raceways terminating at the tray, a listed cable tray clamp or adapter shall be used to securely fasten the raceway to the cable tray system. Additional supporting and securing of the raceway shall be in accordance with the requirements of the appropriate raceway article. For raceways or cables running parallel to and attached to the bottom or side of a cable tray system, fastening and supporting shall be in accordance with the requirements of the appropriate raceway or cable article.

For boxes and conduit bodies attached to the bottom or side of a cable tray system, fastening and supporting shall be in accordance with the requirements of 314.23.

Section 392.18(G) permits conduit and cable termination supports as well as outlet boxes supported solely by the cable tray in qualifying industrial facilities only. These items are not permitted to be supported solely by the cable tray in commercial installations.

For commercial installations (and nonqualifying industrial facilities), conduits must be supported within 3 ft of the cable tray or within 5 ft if structural members do not permit fastening within 3 ft of the cable tray. Cables connecting to equipment outside the cable tray system must be supported according to their respective article. For example, Type MC cable in the larger sizes is required to be supported outside a cable tray system at intervals not exceeding 6 ft, according to 330.30.

Changed From NEC 2008

A new warning label is now required for cable trays that contain conductors rated over 600 volts.

NEC Language

(H) **Marking.** Cable trays containing conductors rated over 600 volts shall have a permanent, legible warning notice carrying the wording “DANGER — HIGH VOLTAGE — KEEP AWAY” placed in a readily visible position on all cable trays, with the spacing of warning notices not to exceed 3 m (10 ft).

This section was added to the 2011 Code. Warning requirements currently exist throughout the NEC where qualified and unqualified persons may encounter over 600-volt circuits and equipment. Cable tray is permitted to be installed in locations accessible to both qualified and unqualified persons. This requirement is intended to protect persons in those locations.

The requirement is an installation requirement because it is a field marking requirement, rather than a manufacturing specification, because manufacturers may not know how the tray will be used.

Article 396 — Messenger-Supported Wiring

This article covers the use, installation, and construction specifications for messenger-supported wiring.

Messenger-supported wiring systems have been manufactured and successfully used in industrial installations for many years. They have also been used for many years as service drops by utilities for commercial and residential installations. There are also references to messenger-supported wiring in 225.6(A)(1) and (B).

II. Installation**396.10 Uses Permitted****NEC Language**

(A) **Cable Types.** The cable types in Table 396.10(A) shall be permitted to be installed in messenger-supported wiring under the conditions described in the article or section referenced for each.

Cable Type	Section	Article
Medium-voltage cable		328
Metal-clad cable		330
Mineral-insulated, metal-sheathed cable		332
Multiconductor service-entrance cable		338
Multiconductor underground feeder and branch-circuit cable		340
Other factory-assembled, multiconductor control, signal, or power cables that are identified for the use		
Power and control tray cable		336
Power-limited tray cable	725.154(C) and 725.179(E)	

NEC 2011

(B) In Industrial Establishments. In industrial establishments only, where conditions of maintenance and supervision ensure that only qualified persons service the installed messenger-supported wiring, the following shall be permitted:

- (1) Any of the conductor types shown in Table 310.104(A) or Table 310.104(B)
- (2) MV cable

Where exposed to weather, conductors shall be listed for use in wet locations. Where exposed to direct rays of the sun, conductors or cables shall be sunlight resistant.

Changed From NEC 2008

396.10(C) Hazardous (Classified) Locations: This was revised for clarity and to indicate there may be other articles that permit the use of the wiring method in a hazardous (classified) location.

NEC Language

(C) Hazardous (Classified) Locations. Messenger-supported wiring shall be permitted to be used in hazardous (classified) locations where the contained cables and messenger-supported wiring are specifically permitted by other articles in this Code.

Article 399 — Outdoor Overhead Conductors over 600 Volts

This article covers the use and installation for outdoor overhead conductors over 600 volts, nominal.

This article is new in the 2011 Code. Premises wiring installations, utilizing over 600-volt systems, currently exist in numerous locations and have become more common as electrical usage has increased. Many of those installations utilize overhead bare conductors on insulators as feeders and branch circuits to safely distribute power to multiple buildings, structures, and equipment locations. This article recognizes this wiring method and provides requirements for these installations.

Changed From NEC 2008

399: This was added to provide the requirements for outdoor overhead conductors operating at over 600 volts nominal.

This Article covers the requirements associated with outdoor overhead conductors over 600 volts. These types of systems have become more common in recent years and are typically found within overhead distribution systems for large electrical system users such as schools, businesses, and other types of campuses. These structures are typically customer owned and fall outside of the control of utility companies.

Many of these installations utilize overhead bare conductors on insulators as feeders and branch circuits to safely distribute power to multiple building, structure and equipment locations.

The wiring methods found in Chapter 3 do not recognize this installation method.

This new Article allows the designers of these systems to utilize existing industry standards for the specific details of these designs and provides enforcement a basis for approval of these types of installations.

Single, overhead conductors over 600 volts insulated or bare may only be used outdoors for services, feeders, or branch circuits.

Please review this Article using your copy of the NEC 2011.

Final Exam

1. **Article 300** also covers communications systems.

- a. True
- b. False

2. **300.3 Conductors (C) Conductors of Different Systems (1) 600 Volts, Nominal, or Less.** Conductors of ac and dc circuits, rated 600 volts, nominal, or less, shall be permitted to occupy the same:

- a. Equipment wiring enclosure
- b. Cable
- c. Raceway
- d. All of the above

3. **300.4(E) Cables, Raceways, or Boxes Installed in or Under Roof Decking.** A cable, raceway, or box, installed in exposed or concealed locations under metal-corrugated sheet roof decking, shall be installed and supported so there is not less than _____ measured from the lowest surface of the roof decking to the top of the cable, raceway, or box.

- a. 1 inch
- b. 1½ inch
- c. 2 inches
- d. 3 inches

4. **300.4(H) Structural Joints:** A listed expansion/deflection fitting or other approved means shall be used where a raceway crosses a structural joint intended for expansion, contraction or deflection, used in buildings, bridges, parking garages, or other structures.

- a. Buildings
- b. Bridges
- c. Parking Garages
- d. All of the above

5. True or False: **300.5 (C) Underground Installations - Exception No. 2:** Type MC Cable listed for direct burial or concrete encasement shall be permitted under a building without installation in a raceway in accordance with 330.10(A)(5) and in wet locations in accordance with 330.10(11).

- a. True
- b. False

6. **300.5(H) Bushing (I) Conductors of the Same Circuit. Exception No. 1:** permits conductors to be installed:

- a. In parallel in raceways
- b. Multiconductor cables
- c. Direct-buried single conductor cables
- d. All of the above

7. True or False: **300.6 Protection Against Corrosion and Deterioration (A) Ferrous Metal Equipment:** This was revised to clarify that corrosion protection must be applied for threads where corrosion protection is necessary if it has not already been applied as part of the manufacturing process.

- a. True
- b. False

8. True or False: **300.7 Raceways Exposed to Different Temperatures (A) Sealing.** Where portions of a raceway or sleeve are known to be subjected to different temperatures, and where condensation is known to be a problem, as in cold storage areas of buildings or where passing from the interior to the exterior of a building, the raceway or sleeve shall be filled with an approved material to prevent the circulation of warm air to a colder section of the raceway or sleeve. An explosion-proof seal is required for this purpose.

- a. True
- b. False

9. True or False: **300.10:** The NEC now requires independent support wires to be identified as specified to distinguish support wires for cables, raceways, etc. from those of the ceiling support system.

- a. True
- b. False

10. **300.11 Securing and Supporting. (A) Secured in Place.** The NEC requires raceways, cable assemblies, boxes, cabinets, and fittings to be securely fastened in place. Which of the statements below is the most accurate?

- a. Support wires that do not provide secure support shall not be permitted as the sole support
- b. Support wires and associated fittings that provide secure support and that are installed in addition to the ceiling grid support wires shall be permitted as the sole support
- c. Where independent support wires are used, they shall be secured at both ends
- d. All of the above

11. True or False: **300.22 (A) Ducts for Dust, Loose Stock, or Vapor Removal.** Wiring systems of any type can be installed in ducts used to transport dust, loose stock, or flammable vapors if properly protected.

- a. True
- b. False

12. **300.22(B) Ducts Specifically Fabricated for Environmental Air** was revised to clarify that the rule applies to plenums used specifically for the movement of environmental air. One of the provisions states that flexible metal conduit shall be permitted, in lengths not to exceed, to connect physically adjustable equipment and devices permitted to be in these fabricated ducts.

- a. 2 ft
- b. 3 ft
- c. 4 ft
- d. 6 ft

13. True or False: **300.22(C)(2) Cable Tray Systems (3) Equipment** states that electrical equipment with a metal enclosure, or electrical equipment with a nonmetallic enclosure listed for use within an air-handling space and having adequate fire-resistant and low-smoke-producing characteristics, and associated wiring material suitable for the ambient temperature shall be permitted to be installed in such other space unless prohibited elsewhere in this Code.

- a. True
- b. False

14. **300.37 Aboveground Wiring Methods** states that aboveground conductors shall be installed in several ways. Which of the statements below is most accurate?

- a. In rigid metal conduit

- b. In electrical metallic tubing
- c. In RTRC and PVC conduit
- d. All of the above

15. True or False: **300.50(B) Wet Locations**: This was added to clarify that the inside of all raceways and enclosures installed underground are considered a wet location, regardless of voltage.

- a. True
- b. False

16. **310.10(E) Informational Note**. The primary purposes of shielding are to _____, and carry ground-fault current to facilitate operation of ground-fault protective devices in the event of an electrical cable fault.

- a. Confine the voltage stresses to the insulation
- b. Dissipate insulation leakage current
- c. Drain off the capacitive charging current
- d. All of the above

17. **310.10(E) Exception No. 2**. This was revised to permit the use of 5000 volt non-shielded cables in certain existing industrial facilities under certain circumstances. Which of the following conditions is not true?

- a. Where the condition of maintenance and supervision ensures that only qualified personnel install and service the installation.
- b. Conductors shall have insulation resistant to electric discharge and surface tracking, or the insulated conductor(s) shall be covered with a material resistant to ozone, electric discharge, and surface tracking.
- c. Where used in dry locations, the insulated conductor(s) shall have an overall nonmetallic jacket or a continuous metallic sheath.
- d. Insulation and jacket thicknesses shall be in accordance with Table 310.13(D).

18. **310.10(H)(1) Exception No. 2**: Under engineering supervision, 2 AWG and 1 AWG grounded neutral conductors shall be permitted to be installed in parallel for existing installations.

- a. 2 AWG and 1 AWG
- b. 3AWG
- c. 4AWG
- d. All of the above

19. True or False: **312.8(3)** requires a label on the enclosure identifying the location of the closest disconnecting means for feed-through conductors.

- a. True
- b. False

20. **314.23(E) Exception**: The following wiring method(s) shall be permitted to support a conduit body of any size, including a conduit body constructed with only one conduit entry, if the trade size of the conduit body is not larger than the largest trade size of the conduit or tubing:

- a. Light metal conduit
- b. Rigid metal conduit, Type RMC
- c. Flexible polyvinyl chloride conduit, Type PVC
- d. All of the above

21. **314.24(A) Outlet Boxes Without Enclosed Devices or Utilization Equipment.** Outlet boxes that do not enclose devices or utilization equipment shall have a minimum internal depth of _____.

- a. 0.25 in
- b. 0.5 in
- c. 0.75 in
- d. 1.0 in

22. **314.27(A)(1) Wall Outlets:** Boxes used at luminaire or lampholder outlets in a wall shall be marked on the interior of the box to indicate the maximum weight of the luminaire that is permitted to be supported by the box in the wall, if other than _____.

- a. 25 lbs
- b. 40 lbs
- c. 50 lbs
- d. 55 lbs

23. **314.28(A)(1): Straight Pulls.** In straight pulls, the length of the box or conduit body shall not be less than _____ the metric designator (trade size) of the largest raceway.

- a. Eight times
- b. Six times
- c. Four times
- d. Three times

24. **314.28(A) (2) Angle or U Pulls, or Splices.** Where splices or where angle or U pulls are made, the distance between each raceway entry inside the box or conduit body and the opposite wall of the box or conduit body shall not be less than _____ the metric designator (trade size) of the largest raceway in a row.

- a. Two times
- b. Three times
- c. Four times
- d. Six times

25. According to **314.30(D) Covers**, handhole enclosure covers shall require the use of tools to open, or they shall weigh over _____.

- a. 60 lbs
- b. 80 lbs
- c. 100 lbs
- d. 70 lbs

26. True or False: **314.72(D) Wiring Is Accessible:** This was revised to include conduit bodies and to clarify the conductors must be accessible without damaging any fixed part of the building or structure.

- a. True
- b. False

27. **320.23(A) Cables Run Across the Top of Floor Joists.** Where run across the top of floor joists, or within 2.1 m (____) of the floor or floor joists across the face of rafters or studding, the cable shall be protected by substantial guard strips that are at least as high as the cable. Where this space is not accessible by permanent stairs or ladders, protection shall only be required within 1.8 m (____) of the nearest edge of the scuttle hole or attic entrance.

- a. 5 ft — 6 ft

- b. 7 ft — 6 ft
- c. 4 ft — 6 f.
- d. 6 ft — 6 ft

28. **320.80(A) Thermal Insulation:** Armored cable installed in thermal insulation shall have conductors rated at _____.

- a. 180°F
- b. 190°F
- c. 194°F
- d. 200°F

29. **320.80(A) Thermal Insulation:** The ampacity of armored cable installed in thermal insulation shall not exceed that of a _____ rated conductor.

- a. 120°F
- b. 130°F
- c. 140°F
- d. 150°F

30. True or False: **328.14 Installation** was added to require qualified persons for installation, terminating, and testing of Type MV cable.

- a. True
- b. False

31. True or False: **Under 334.10 Uses Permitted (1)** Type NM, Type NMC, and Type NMS cables are not permitted to be used in attached and detached garages and their storage buildings.

- a. True
- b. False

32. **334.15(B) Protection from Physical Damage** states that Cable shall be protected from physical damage where necessary by several means, including:

- a. Intermediate metal conduit
- b. Schedule 80 PVC conduit
- c. Type RTRC marked with the suffix -XW
- d. All of the above

33. **334.15(B)** also requires that, where passing through a floor, the cable shall be enclosed in approved conduit or tubing extending at least _____ above the floor.

- a. 4 in
- b. 6 in
- c. 8 in
- d. 10 in

34. True or False: **338.10(B)(2) Use of Uninsulated Conductor** states that Type SE service-entrance cable is not permitted for use where the insulated conductors are used for circuit wiring and the uninsulated conductor is used only for equipment grounding purposes.

- a. True
- b. False

35. **338.10(B)(4) Installation Methods for Branch Circuits and Feeders (a) Interior Installations:** The ampacity of SE cable installed in thermal insulation cannot exceed the 60°C temperature rating.

- a. 90°C
- b. 80°C
- c. 70°C
- d. 60°C

36. **342.30(A) Use of Uninsulated Conductor: Securely Fastened.** IMC shall be secured in accordance with one of the following:

- a. IMC shall be securely fastened within 3 ft of each outlet box, junction box, device box, cabinet, conduit body, or other conduit termination.
- b. Where structural members do not readily permit fastening within 3.5 ft, fastening shall be permitted to be increased to a distance of 1.5 m (5 ft).
- c. Where approved, conduit shall not be required to be securely fastened within 900 mm (6 ft) of the service head for above-the-roof termination of a mast.
- d. All of the above

37. True or False: **342.46** states that where a conduit enters a box, fitting, or other enclosure, a bushing shall be provided to protect the wires from abrasion unless the box, fitting, or enclosure is designed to provide such protection.

- a. True
- b. False

38. **348.30(A) Exception 2** was revised to describe where the measurements are made. Where applicable, where flexibility is necessary after installation, lengths from the last point where the raceway is securely fastened shall not exceed which of the following:

- a. 900 mm (3 ft) for metric designators 16 through 35 (trade sizes ½ through 1¼)
- b. 1200 mm (4 ft) for metric designators 41 through 53 (trade sizes 1½ through 2)
- c. 1500 mm (5 ft) for metric designators 63 (trade size 2½) and larger
- d. Any of the previous where applicable

39. True or False: **348.42 Couplings and Connectors** states that angle connectors for flexible metal conduit cannot be installed where the angle connector itself will be concealed.

- a. True
- b. False

40. True or False: **352.10 Uses Permitted**, does not allow the use of PVC conduit in extreme cold, because it may cause some nonmetallic conduits to become brittle and, therefore, more susceptible to damage from physical contact.

- a. True
- b. False

41. **353.10 Uses Permitted [High Density Polyethylene Conduit (Type HDPE)].** The use of HDPE conduit shall be permitted under the following conditions:

- a. In locations not subject to severe corrosive influences as covered in 300.6 and where subject to chemicals for which the conduit is listed
- b. In cinder fill
- c. Not in direct burial installations in earth or concrete
- d. All of the above.

42. **353.10(6):** Conductors or cables rated at a temperature higher than the listed temperature rating of HDPE conduit shall be permitted to be installed in HDPE conduit, provided the

conductors or cables are not operated at a temperature _____ than the listed temperature rating of the HDPE conduit.

- a. Below
- b. Higher
- c. Equivalent
- d. None of the above

43. **358.10(B)** states that ferrous or nonferrous EMT, elbows, couplings, and fittings shall be permitted to be installed:

- a. In concrete
- b. In direct contact with the earth
- c. In areas subject to severe corrosive influences where protected by corrosion protection and approved as suitable for the condition.
- d. All of the above

44. True or False: **362.10(9)** states that conductors or cables rated at a temperature higher than the listed temperature rating of ENT shall be permitted to be installed in ENT, if the conductors or cables are not operated at a temperature higher than the listed temperature rating of the ENT.

- a. True
- b. False

45. **366.22(A) Sheet Metal Auxiliary Gutters:** The sum of the cross-sectional areas of all contained conductors at any cross section of a sheet metal auxiliary gutter shall not exceed _____ of the interior cross-sectional area of the sheet metal auxiliary gutter.

- a. 10%
- b. 15%
- c. 20%
- d. 25%

46. **368.10 (B) Uses Permitted (Busways) - Behind Access Panels:** Busways shall be permitted to be installed behind access panels, provided:

- a. The busways are totally enclosed
- b. They are of nonventilating-type construction
- c. They are installed so that the joints between sections and at fittings are accessible for maintenance purposes
- d. All of the above

47. **368.10 (B) Uses Permitted (Busways) - Behind Access Panels:** Where busways are installed behind access panels, means of access shall be provided, and either of the following conditions shall be met:

- a. The space behind the access panels shall not be used for air-handling purposes.
- b. Where the space behind the access panels is used for environmental air, other than ducts and plenums, there shall be provisions for plug-in connections, and the conductors shall be insulated.
- c. Unbroken lengths of busway shall not be permitted to be extended through dry walls.
- d. Busways shall be permitted to be extended vertically through dry floors if totally enclosed (unventilated) where passing through and for a minimum distance of 3 ft above the floor to provide adequate protection from physical damage.

48. **368.10 (C)(2) b. Uses Permitted (Busways) - Behind Access Panels:** In other than industrial establishments, where a vertical riser penetrates two or more dry floors, a minimum

_____ high curb shall be installed around all floor openings for riser busways to prevent liquids from entering the opening.

- a. 3 in
- b. 4 in
- c. 5 in
- d. 6 in

49. According to ARTICLE 392, Cable Trays are:

- a. Raceways
- b. Trays
- c. Mechanical Support Systems
- d. All of the above

50. Under **392.18 (H) Marking**, Cable trays containing conductors rated over 600 volts shall have a permanent, legible warning notice carrying the wording "DANGER — HIGH VOLTAGE — KEEP AWAY" placed in a readily visible position on all cable trays, with the spacing of warning notices not to exceed _____.

- a. 6 ft
- b. 7 ft
- c. 8 ft
- d. 10 ft

Attachment #2: Instructor Information

Course Instructor:

Joe Crump

Florida Certified Electrical Contractor AC# 2712320

Mr. Crump's resume is attached for review.

Joe H. Crump

1900 Winchester Road North, Saint Petersburg FL 33710
Home (727) 343-0713 Work (727) 224-8200

Experience

L. Crump Electric, Saint Petersburg, Fl.

Owner, 1973-Present

Schedule and control up to 75 full time employees. Residential, commercial, and industrial appraiser.

U.S. Army Corp of Engineering, United States Army

Electrical Engineer, 1969-1972

Designed and implemented wiring for military bases. Supervised quality control.

Certification

1966 Journeyman Electrical Certified

1969 Master Electrician — City of Saint Petersburg, FL

1969 United States Civil Service — Skilled Electrician

1970 Department of the Army — Construction Foreman Course

1990 Master Electrician — State of Florida

1991 Southern Building Code Congress — Residential Electrical Inspector

1992 Southern Building Code Congress — Commercial Electrical Inspector

1992 Building Officials and Code Administrators International, Inc. — Certified as a Electrical Inspector

1992 Southern Building Code Congress — Certified as Electrical inspector

1992 Grounding and Bonding Certified

1992 National Certification Program — 1 & 2 Family Housing

1993 National Certification Program — Electrical General

1993 National Certification Program — Commercial

1993 Business Industry Training Institute, Northwest Iowa Community College — 1993 Florida Boards of Building Codes and Standards Certified

1996 NFPA Board Certified into the Electrical Section

1996 Teacher with Pinellas County Vocation Tech School

1996 National Certified as A Board Electrical Contractor

2008 — Florida Certified Electrical Contractor AC# 2712320

2008 — PCCLB License #I-EC 13002856

Education

Attended Florida Beacon College

Bachelor Degree from Rhodes College

MBA from Florida Metropolitan University

Attachment #3: Course Materials and Fees

Course Material:

The course is reviewed online and is available to anyone who purchases it 24/7 as long as there is computer and internet access.

All material necessary to complete the course is included by viewing online. Students are not directed to additional material as a requirement for course completion, only as added information for personal interest.

Course Fee:

The fee for this course is \$44.85

Attachment #4: Schedule of Course Dates and Locations

This course is presented in an online format. The course is available at www.RedVector.com 24 hours a day, 7 days a week to anyone with computer and internet access.

SAMPLE

Certificate of Completion

John Doe

VA License #: 123456

has successfully completed the following course

Series B: 2011 NEC Code Changes - Chapter 3 (RV-10287)

This online course is approved for 3 continuing education hours

XXXXXXXXXX

date of course completion

Course Completion Date

Course Approval

Matthew Casey, PhD, VP of Content

RedVector.com

AIA Registered Provider #J315

FL DBPR Approved Provider #0001771

FBPE Approved Provider #33



Two Urban Centre • 4890 West Kennedy Boulevard Suite 740 • Tampa, FL 33609

Attachment #6: Online/Correspondence Course Information

Security Procedures Utilized:

All students must register with the web site to gain access to their online course(s). The registration process creates a unique user profile and records their personal information including name, address, phone, email, username, password, licenses held, and license number(s). This information is automatically recorded and saved electronically.

We monitor required student participation in the course by logging and tracking the date and time a student enters a course, tracking activity during the course, and recording the date and time they complete the exam with a required passing score. If our learning management system detects 13-minutes of inactivity, a pop-up appears alerting the student that they must verify their presence or the session times out and the course closes.

In addition, at the completion of an exam, before it is graded, students are asked to confirm an affidavit indicating they personally completed the entire course. They must also confirm their identity before their exam is graded. This confirmation is stored in our database for audit purposes.

Once a student completes and passes the course with a grade of 70% or higher, they are given a certificate of completion and the course completion is recorded in their user profile, along with date and time completed.

End of Course Test:

A copy is attached for review.

Online Course Access:

The Board has been set up with a test account to preview courses on the RedVector.com website. To access the courses, please follow the directions below.

1. Log on to the web site at <http://www.RedVector.com>
2. On the top center of the page click the orange "Sign-In" button.
3. In the gray column labeled "Returning Users" enter your username **VAELEC** and your password **vaelec (both are case-sensitive)**. Click the "LOGIN" button.
4. You should arrive at the User Menu. Click on the second box "My Courses".
5. A list of courses will appear. Click on the title of the course you wish to begin and follow the instructions.

[Print](#)**Exam: 2011 NEC Code Changes - Chapter 3 (4 hour)**

1. Article 300 also covers communications systems.
 - A. TRUE
 - B. FALSE

2. 300.3 Conductors (C) Conductors of Different Systems (1) 600 Volts, Nominal, or Less. Conductors of ac and dc circuits, rated 600 volts, nominal, or less, shall be permitted to occupy the same:
 - A. Equipment wiring enclosure
 - B. Cable
 - C. Raceway
 - D. All of the above

3. 300.4(E) Cables, Raceways, or Boxes Installed in or Under Roof Decking. A cable, raceway, or box, installed in exposed or concealed locations under metal-corrugated sheet roof decking, shall be installed and supported so there is not less than _____ measured from the lowest surface of the roof decking to the top of the cable, raceway, or box.
 - A. 1 inch
 - B. 1½ inch
 - C. 2 inches
 - D. 3 inches

4. 300.4(H) Structural Joints: A listed expansion/deflection fitting or other approved means shall be used where a raceway crosses a structural joint intended for expansion, contraction or deflection, used in buildings, bridges, parking garages, or other structures.
 - A. Buildings
 - B. Bridges
 - C. Parking Garages
 - D. All of the above

5. True or False: 300.5 (C) Underground Installations - Exception No. 2: Type MC Cable listed for direct burial or concrete encasement shall be permitted under a building without installation in a raceway in accordance with 330.10(A)(5) and in wet locations in accordance with 330.10(11).
 - A. TRUE
 - B. FALSE

6. 300.5(H) Bushing (I) Conductors of the Same Circuit. Exception No. 1: permits conductors to be installed:
 - A. In parallel in raceways
 - B. Multiconductor cables

- C. Direct-buried single conductor cables
 - D. All of the above
7. True or False: 300.6 Protection Against Corrosion and Deterioration (A) Ferrous Metal Equipment: This was revised to clarify that corrosion protection must be applied for threads where corrosion protection is necessary if it has not already been applied as part of the manufacturing process.
- A. TRUE
 - B. FALSE
8. True or False: 300.7 Raceways Exposed to Different Temperatures (A) Sealing. Where portions of a raceway or sleeve are known to be subjected to different temperatures, and where condensation is known to be a problem, as in cold storage areas of buildings or where passing from the interior to the exterior of a building, the raceway or sleeve shall be filled with an approved material to prevent the circulation of warm air to a colder section of the raceway or sleeve. An explosion-proof seal is required for this purpose.
- A. TRUE
 - B. FALSE
9. True or False: 300.10: The NEC now requires independent support wires to be identified as specified to distinguish support wires for cables, raceways, etc. from those of the ceiling support system.
- A. TRUE
 - B. FALSE
10. 300.11 Securing and Supporting. (A) Secured in Place. The NEC requires raceways, cable assemblies, boxes, cabinets, and fittings to be securely fastened in place. Which of the statements below is the most accurate?
- A. Support wires that do not provide secure support shall not be permitted as the sole support
 - B. Support wires and associated fittings that provide secure support and that are installed in addition to the ceiling grid support wires shall be permitted as the sole support
 - C. Where independent support wires are used, they shall be secured at both ends
 - D. All of the above
11. True or False: 300.22 (A) Ducts for Dust, Loose Stock, or Vapor Removal. Wiring systems of any type can be installed in ducts used to transport dust, loose stock, or flammable vapors if properly protected.
- A. TRUE
 - B. FALSE
12. 300.22(B) Ducts Specifically Fabricated for Environmental Air was revised to clarify that the rule applies to plenums used specifically for the movement of environmental air. One of the provisions states that flexible metal conduit shall be permitted, in lengths not to exceed, to connect physically adjustable equipment and devices permitted to be in these fabricated ducts.
- A. 2 feet

- B. 3 feet
 - C. 4 feet
 - D. 6 feet
13. True or False: 300.22(C)(2) Cable Tray Systems (3) Equipment states that electrical equipment with a metal enclosure, or electrical equipment with a nonmetallic enclosure listed for use within an air-handling space and having adequate fire-resistant and low-smoke-producing characteristics, and associated wiring material suitable for the ambient temperature shall be permitted to be installed in such other space unless prohibited elsewhere in this Code.
- A. TRUE
 - B. FALSE
14. 300.37 Aboveground Wiring Methods states that aboveground conductors shall be installed in several ways. Which of the statements below is most accurate?
- A. In rigid metal conduit
 - B. In electrical metallic tubing
 - C. In RTRC and PVC conduit
 - D. All of the above
15. True or False: 300.50(B) Wet Locations: This was added to clarify that the inside of all raceways and enclosures installed underground are considered a wet location, regardless of voltage.
- A. TRUE
 - B. FALSE
16. 310.10(E) Informational Note. The primary purposes of shielding are to _____, and carry ground-fault current to facilitate operation of ground-fault protective devices in the event of an electrical cable fault.
- A. Confine the voltage stresses to the insulation
 - B. Dissipate insulation leakage current
 - C. Drain off the capacitive charging current
 - D. All of the above
17. 310.10(E) Exception No. 2. This was revised to permit the use of 5000 volt non-shielded cables in certain existing industrial facilities under certain circumstances. Which of the following conditions is not true?
- A. Where the condition of maintenance and supervision ensures that only qualified personnel install and service the installation.
 - B. Conductors shall have insulation resistant to electric discharge and surface tracking, or the insulated conductor(s) shall be covered with a material resistant to ozone, electric discharge, and surface tracking.
 - C. Where used in dry locations, the insulated conductor(s) shall have an overall nonmetallic jacket or a continuous metallic sheath.
 - D. Insulation and jacket thicknesses shall be in accordance with Table 310.13(D).
18. 310.10(H)(1) Exception No. 2: Under engineering supervision. 2 AWG and 1 AWG grounded

neutral conductors shall be permitted to be installed in parallel for existing installations.

- A. 2 AWG and 1 AWG
- B. 3AWG
- C. 4AWG
- D. All of the above

19. True or False: 312.8(3) requires a label on the enclosure identifying the location of the closest disconnecting means for feed-through conductors.
- A. TRUE
 - B. FALSE
20. 314.23(E) Exception: The following wiring method(s) shall be permitted to support a conduit body of any size, including a conduit body constructed with only one conduit entry, if the trade size of the conduit body is not larger than the largest trade size of the conduit or tubing:
- A. Light metal conduit
 - B. Rigid metal conduit, Type RMC
 - C. Flexible polyvinyl chloride conduit, Type PVC
 - D. All of the above
21. 314.24(A) Outlet Boxes Without Enclosed Devices or Utilization Equipment. Outlet boxes that do not enclose devices or utilization equipment shall have a minimum internal depth of _____.
- A. ¼ in.
 - B. ½ in.
 - C. .75 in.
 - D. 1.0 in.
22. 314.27(A)(1) Wall Outlets: Boxes used at luminaire or lampholder outlets in a wall shall be marked on the interior of the box to indicate the maximum weight of the luminaire that is permitted to be supported by the box in the wall, if other than ____.
- A. 25 lb.
 - B. 40 lb.
 - C. 50 lb.
 - D. 55 lb.
23. 314.28(A)(1): Straight Pulls. In straight pulls, the length of the box or conduit body shall not be less than ____ the metric designator (trade size) of the largest raceway.
- A. Eight times
 - B. Six times
 - C. Four times
 - D. Three times
24. 314.28(A) (2) Angle or U Pulls, or Splices. Where splices or where angle or U pulls are made, the distance between each raceway entry inside the box or conduit body and the opposite wall of the box or conduit body shall not be less than _____ the metric designator (trade size) of the largest raceway in a row.

- A. Two times
 - B. Three times
 - C. Four times
 - D. Six times
25. According to 314.30(D) Covers, handhole enclosure covers shall require the use of tools to open, or they shall weigh over _____.
- A. 60 lbs
 - B. 80 lbs
 - C. 100 lbs
 - D. 70 lbs
26. True or False: 314.72(D) Wiring Is Accessible: This was revised to include conduit bodies and to clarify the conductors must be accessible without damaging any fixed part of the building or structure.
- A. TRUE
 - B. FALSE
27. 320.23(A) Cables Run Across the Top of Floor Joists. Where run across the top of floor joists, or within 2.1 m (____) of the floor or floor joists across the face of rafters or studding, the cable shall be protected by substantial guard strips that are at least as high as the cable. Where this space is not accessible by permanent stairs or ladders, protection shall only be required within 1.8 m (____) of the nearest edge of the scuttle hole or attic entrance.
- A. 5 ft — 6 ft
 - B. 7 ft — 6 ft
 - C. 4 ft — 6 ft
 - D. 6 ft — 6 ft
28. 320.80(A) Thermal Insulation: Armored cable installed in thermal insulation shall have conductors rated at ____.
- A. 180°F
 - B. 190°F
 - C. 194°F
 - D. 200°F
29. 320.80(A) Thermal Insulation: The ampacity of armored cable installed in thermal insulation shall not exceed that of a ____ rated conductor.
- A. 120°F
 - B. 130°F
 - C. 140°F
 - D. 150°F
30. True or False: 328.14 Installation was added to require qualified persons for installation, terminating, and testing of Type MV cable.
- A. TRUE

B. FALSE

31. True or False: Under 334.10 Uses Permitted (1) Type NM, Type NMC, and Type NMS cables are not permitted to be used in attached and detached garages and their storage buildings.
- A. TRUE
 - B. FALSE
32. 334.15(B) Protection from Physical Damage states that Cable shall be protected from physical damage where necessary by several means, including:
- A. Intermediate metal conduit
 - B. Schedule 80 PVC conduit
 - C. Type RTRC marked with the suffix -XW
 - D. All of the above
33. 334.15(B) also requires that, where passing through a floor, the cable shall be enclosed in approved conduit or tubing extending at least _____ above the floor.
- A. 4 in.
 - B. 6 in.
 - C. 8 in.
 - D. 10 in.
34. True or False: 338.10(B)(2) Use of Uninsulated Conductor states that Type SE service-entrance cable is not permitted for use where the insulated conductors are used for circuit wiring and the uninsulated conductor is used only for equipment grounding purposes
- A. TRUE
 - B. FALSE
35. 338.10(B)(4) Installation Methods for Branch Circuits and Feeders (a) Interior Installations: The ampacity of SE cable installed in thermal insulation cannot exceed the 60°C temperature rating.
- A. 90°C
 - B. 80°C
 - C. 70°C
 - D. 60°C
36. 342.30(A) Use of Uninsulated Conductor: Securely Fastened. IMC shall be secured in accordance with one of the following:
- A. IMC shall be securely fastened within 3 ft of each outlet box, junction box, device box, cabinet, conduit body, or other conduit termination.
 - B. Where structural members do not readily permit fastening within 3.5 ft, fastening shall be permitted to be increased to a distance of 1.5 m (5 ft).
 - C. Where approved, conduit shall not be required to be securely fastened within 900 mm (6 ft) of the service head for above-the-roof termination of a mast.
 - D. All of the above

37. True or False: 342.46 states that where a conduit enters a box, fitting, or other enclosure, a bushing shall be provided to protect the wires from abrasion unless the box, fitting, or enclosure is designed to provide such protection.
- A. TRUE
 - B. FALSE
38. 348.30(A) Exception 2 was revised to describe where the measurements are made. Where applicable, where flexibility is necessary after installation, lengths from the last point where the raceway is securely fastened shall not exceed which of the following:
- A. 900 mm (3 ft) for metric designators 16 through 35 (trade sizes ½ through 1¼)
 - B. 1200 mm (4 ft) for metric designators 41 through 53 (trade sizes 1½ through 2)
 - C. 1500 mm (5 ft) for metric designators 63 (trade size 2½) and larger
 - D. Any of the previous where applicable
39. True or False: 348.42 Couplings and Connectors states that angle connectors for flexible metal conduit cannot be installed where the angle connector itself will be concealed.
- A. TRUE
 - B. FALSE
40. True or False: 352.10 Uses Permitted, does not allow the use of PVC conduit in extreme cold. because it may cause some nonmetallic conduits to become brittle and, therefore, more susceptible to damage from physical contact.
- A. TRUE
 - B. FALSE
41. 353.10 Uses Permitted [High Density Polyethylene Conduit (Type HDPE)]. The use of HDPE conduit shall be permitted under the following conditions:
- A. In locations not subject to severe corrosive influences as covered in 300.6 and where subject to chemicals for which the conduit is listed
 - B. In cinder fill
 - C. Not in direct burial installations in earth or concrete
 - D. All of the above.
42. 353.10(6): Conductors or cables rated at a temperature higher than the listed temperature rating of HDPE conduit shall be permitted to be installed in HDPE conduit, provided the conductors or cables are not operated at a temperature ___ than the listed temperature rating of the HDPE conduit.
- A. Below
 - B. Higher
 - C. Equivalent
 - D. None of the above
43. 358.10(B) states that ferrous or nonferrous EMT, elbows, couplings, and fittings shall be permitted to be installed:
- A. In concrete

- B. In direct contact with the earth
 - C. In areas subject to severe corrosive influences where protected by corrosion protection and approved as suitable for the condition.
 - D. All of the above
44. True or False: 362.10(9) states that conductors or cables rated at a temperature higher than the listed temperature rating of ENT shall be permitted to be installed in ENT, if the conductors or cables are not operated at a temperature higher than the listed temperature rating of the ENT.
- A. TRUE
 - B. FALSE
45. 366.22(A) Sheet Metal Auxiliary Gutters: The sum of the cross-sectional areas of all contained conductors at any cross section of a sheet metal auxiliary gutter shall not exceed ___ of the interior cross-sectional area of the sheet metal auxiliary gutter.
- A. 10%
 - B. 15%
 - C. 20%
 - D. 25%
46. 368.10 (B) Uses Permitted (Busways) - Behind Access Panels: Busways shall be permitted to be installed behind access panels, provided:
- A. The busways are totally enclosed
 - B. They are of nonventilating-type construction
 - C. They are installed so that the joints between sections and at fittings are accessible for maintenance purposes
 - D. All of the above
47. 368.10 (B) Uses Permitted (Busways) - Behind Access Panels: Where busways are installed behind access panels, means of access shall be provided, and either of the following conditions shall be met:
- A. The space behind the access panels shall not be used for air-handling purposes.
 - B. Where the space behind the access panels is used for environmental air, other than ducts and plenums, there shall be provisions for plug-in connections, and the conductors shall be insulated.
 - C. Unbroken lengths of busway shall not be permitted to be extended through dry walls.
 - D. Busways shall be permitted to be extended vertically through dry floors if totally enclosed (unventilated) where passing through and for a minimum distance of 3 ft above the floor to provide adequate protection from physical damage.
48. 368.10 (C)(2) b. Uses Permitted (Busways) - Behind Access Panels: In other than industrial establishments, where a vertical riser penetrates two or more dry floors, a minimum ___ inch high curb shall be installed around all floor openings for riser busways to prevent liquids from entering the opening.
- A. 3
 - B. 4
 - C. 5

D. 6

49. According to ARTICLE 392, Cable Trays are:
- A. Raceways
 - B. Trays
 - C. Mechanical Support Systems
 - D. All of the above
50. Under 392.18 (H) Marking, Cable trays containing conductors rated over 600 volts shall have a permanent, legible warning notice carrying the wording "DANGER — HIGH VOLTAGE — KEEP AWAY" placed in a readily visible position on all cable trays, with the spacing of warning notices not to exceed _____.
- A. 6 ft
 - B. 7 ft
 - C. 8 ft
 - D. 10 ft

Attachment #1: Course Syllabus

Course Title:

Series B: 2011 NEC Code Changes - Chapter 4 (RV-10288)

Course Hours:

3 hours

Course Instructor:

Joe Crump

Course Description:

The NFPA® updates to the NEC Code periodically – you need to know the latest updates and the reasons for them.

This **interactive online** course provides you with everything you need to be familiar with the NEC Code – specifically the 2011 version. For all of the major Code changes covered, you'll get:

- A summary addressing each relevant Change.
- Excerpts of actual 2011 National Electrical Code® text with relevant Staff comments and illustrations.
- First-time articles, usability improvements, and revisions that boost electrical safety making the 2011 National Electrical Code® essential.

Course Objectives:

At the conclusion of this course, you will be able to:

- Identify the various significant changes in Chapter 4 of the NEC
- Recognize the reasons for changes to existing Code
- List new articles in the Code
- Describe deletions in some existing requirements

Course Outline:

Introduction

Ch. 4 Articles 400.4-409.110

- Article 400 — Flexible Cords and Cables
- 400.4 Types
- 400.5 Ampacities for Flexible Cords and Cables
- 400.7 Uses Permitted
- 400.21 Construction
- 400.31 Construction
- Article 404 — Switches
- 404.1 Scope
- 404.2 Switch Connections
- 404.4 Damp or Wet Locations
- 404.8 Accessibility and Grouping
- 404.9 Provisions for General-Use Snap Switches
- 404.14 Rating and Use of Snap Switches
- Article 406 — Receptacles, Cord Connectors, and Attachment Plugs (Caps)
- 406.2 Definition

- 406.4 General Installation Requirements
- 406.6 Receptacle Faceplates (Cover Plates)
- 406.9 Receptacles in Damp or Wet Locations
- 406.12 Tamper-Resistant Receptacles in Dwelling Unit
- 406.13 Tamper-Resistant Receptacles in Guest Rooms and Guest Suites
- 406.14 Tamper-Resistant Receptacles in Child Care Facilities
- Article 408 — Switchboards and Panelboards
- 408.1 Scope
- 408.3 Support and Arrangement of Busbars and Conductors
- 408.4 Field Identification Required
- 408.30 General
- Article 409 — Industrial Control Panels
- 409.22 Short-Circuit Current Rating
- 409.102 Busbars and Conductors
- 409.104 Wiring Space
- 409.110 Marking

Ch. 4 Articles 410.76-426.28

- Article 410 — Luminaires, Lampholders, and Lamps
- 410.16 Luminaires in Clothes Closets
- 410.20 Space for Conductors
- 410.24 Connection of Electric-Discharge and LED Luminaires
- 410.42 Luminaire(s) with Exposed Conductive Parts
- 410.62 Cord-Connected Lampholders and Luminaires
- 410.64 Luminaires as Raceways
- 410.68 Feeder and Branch-Circuit Conductors and Ballasts
- 410.74 Luminaire Rating
- 410.96 Lampholders in Wet or Damp Locations
- 410.97 Lampholders Near Combustible Material
- 410.110 General
- 410.122 Lampholders
- 410.130 General
- 410.136 Luminaire Mounting
- 410.137 Equipment Not Integral with Luminaire
- Article 422 — Appliances
- 422.2 Definition
- 422.15 Central Vacuum Outlet Assemblies
- 422.30 General
- 422.31 Disconnection of Permanently Connected Appliances
- Article 424 — Fixed Electric Space-Heating Equipment
- 424.3 Branch Circuits
- 424.19 Disconnecting Means
- 424.28 Nameplate
- 424.39 Clearance from Other Objects and Openings
- 424.44 Installation of Cables in Concrete or Poured Masonry Floors
- Article 426 — Fixed Outdoor Electric De-icing and Snow-Melting Equipment
- 426.2 Definitions

- 426.20 Embedded Deicing and Snow-Melting Equipment
- 426.28 Ground-Fault Protection of Equipment

Ch. 4 Articles 430.6-430.245

- Article 430 — Motors, Motor Circuits, and Controllers
- 430.6 Ampacity and Motor Rating Determination
- 430.12 Motor Terminal Housings
- 430.22 Single Motor
- 430.24 Several Motors or a Motor(s) and Other Load(s)
- 430.42 Motors on General-Purpose Branch Circuits
- 430.52 Rating or Setting for Individual Motor Circuit
- 430.53 Several Motors or Loads on One Branch Circuit
- 430.63 Rating or Setting — Motor Load and Other Load(s)
- 430.74 Electrical Arrangement of Control Circuits
- 430.81 General
- 430.94 Overcurrent Protection
- 430.109 Type
- 430.122 Conductors — Minimum Size and Ampacity
- 430.225 Motor-Circuit Overcurrent Protection
- 430.245 Method of Grounding

Ch. 4 Articles 440.55-490.74

- Article 440 — Air-Conditioning and Refrigerating Equipment
- 440.55 Cord-and-Attachment-Plug-Connected Motor-Compressors and Equipment on 15- or 20-Ampere Branch Circuits
- 440.63 Disconnecting Means
- Article — 445 Generators
- 445.1 Scope
- 445.12 Overcurrent Protection
- 445.19 Generators Supplying Multiple Loads
- Article 450 — Transformers and Transformer Vaults (Including Secondary Ties)
- 450.14 Disconnecting Means
- Article 480 — Storage Batteries
- 480.2 Definitions
- 480.5 Disconnecting Means
- Article 490 — Equipment, Over 600 Volts, Nominal
- 490.21 Circuit-Interrupting Devices
- 490.22 Isolating Means
- 490.33 Guarding of Energized Parts Operating at 600 Volts, Nominal, or Less Within Compartments
- 490.35 Accessibility of Energized Parts
- 490.40 Visual Inspection Windows
- 490.41 Location of Industrial Control Equipment
- 490.74 Bonding



2011 NEC[®] Code Changes – Chapter 4

Developed by National Green Building, Inc.

Course Description

The NFPA updates to the NEC Code periodically – you need to know the latest updates and the reasons for them.

This **interactive online** course provides you with everything you need to be familiar with the NEC Code – specifically the 2011 version. For all of the major Code changes covered, you'll get:

- A summary addressing each relevant Change.
- Excerpts of actual 2011 National Electrical Code text with relevant Staff comments and illustrations.
- First-time articles, usability improvements, and revisions that boost electrical safety making the 2008 National Electrical Code essential.

Performance Objectives

At the conclusion of this course, you will be able to:

- Identify the various significant changes in Chapter 4 of the NEC
- Recognize the reasons for changes to existing Code
- List new articles in the Code
- Describe deletions in some existing requirements

References

1. NFPA. *2011 National Electric Code (NEC)*, 2010
2. NFPA. *NEC Plus*, 2010
3. International Association of Electrical Inspectors. *NEC 2011 — Analysis of Changes*, 2010.
4. Mike Holt Enterprises. *Changes to the NEC 2011*, 2010

The designations "*National Electric Code*" and "*NEC*" refer to *NFPA 70, National Electric Code*, which is a registered trademark of the *National Fire Protection Association*.

NOTE:

The National Electric Code is intended for electricians and subcontractors, electrical inspectors, electrical engineers, designers, and other qualified persons who understand electrical currents, theory, safety procedures, and electrical trade practices. The code does not serve as a teaching manual for untrained individuals.

Chapter 4 — Equipment for General Use

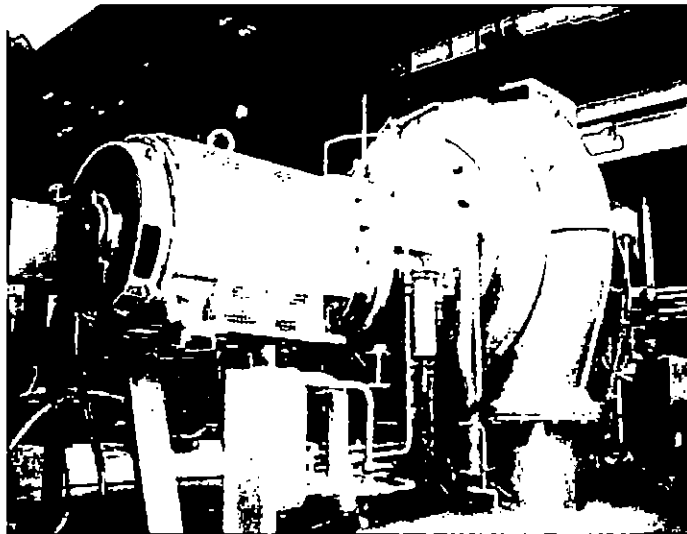

IAEI Magazine

Chapter 4 helps to apply the first three chapters to installations involving general equipment. The first four chapters follow a natural sequence. Each of the next four NEC chapters – 5, 6, 7, and 8 – build upon the first four, but in no particular order. It's important to understand all of the first four chapters to properly apply any of the next.

Article 400 — Flexible Cords and Cables

Article 400 covers general requirements, applications, and construction specifications for flexible cords and flexible cables. The NEC does not consider flexible cords to be wiring methods like those described in Chapter 3. Always use a cord and fittings identified for the application. To help with this, Table 440.4 is available.

I. General

400.4 Types

This section and the accompanying Table address the question of sunlight resistance for cords.

NEC Language

Flexible cords and flexible cables shall conform to the description in Table 400.4. Types of flexible cords and flexible cables other than those listed in the table shall be the subject of special investigation.

Changed From NEC 2008

Table 400.4 Note 15: This was revised to indicate that outer covering of a cord marked with “W” suffix is sunlight resistant.

Trade Name	Type Letter	Voltage	AWG or kcmil	Number of Conductors	Insulation	AWG or kcmil	Nominal Insulation Thickness ¹		Braid on Each Conductor	Outer Covering	Use		
							mm	mils			Pendant or portable	Dry locations	Not hard usage
Lamp cord	C	300 600	18-16 14-10	2 or more	Thermoset or thermoplastic	18-16 14-10	0.76 1.14	30 45	Cotton	None	Pendant or portable	Dry locations	Not hard usage
Elevator cable	E See Note 7. See Note 11. See Note 12.	300 or 600	20-2	2 or more	Thermoset	20-16 14-12 12-10 8-2	0.51 0.76 1.14 1.52	20 30 45 60	Cotton	Three cotton. Outer one flame-retardant & moisture-resistant. See Note 5.	Elevator lighting and control	Unclassified locations	
						20-16 14-12 12-10 8-2	0.51 0.76 1.14 1.52	20 30 45 60	Flexible nylon jacket				
Elevator cable	EO See Note 7. See Note 12.	300 or 600	20-2	2 or more	Thermoset	20-16 14-12 12-10 8-2	0.51 0.76 1.14 1.52	20 30 45 60	Cotton	Outer one Three cotton, flame-retardant & moisture-resistant. See Note 5.	Elevator lighting and control	Unclassified locations	
										One cotton and a neoprene jacket. See Note 5.		Hazardous (classified) locations	
Elevator cable	ETP See Note 7. See Note 12.	300 or 600							Rayon	Thermoplastic	Hazardous (classified) locations		
	ETT See Note 7. See Note 12.								None	One cotton or equivalent and a thermoplastic jacket			

(Continues)

NEC 2011

You may need to review this table with your copy of the NEC 2011

400.5 Ampacities for Flexible Cords and Cables

This makes an editorial change to the ampacity correction requirements.

(A) Ampacity Tables.

Changed From NEC 2008

Tables 400.5(A)(1) & (A)(2): This was revised to clarify that ampacities apply to copper conductors.

Flexible cords and cables used in ambient temperatures below 30° C (86° F) now require ambient temperature adjustment correction factors.

NEC Language

Table 400.5(A)(1) provides the allowable ampacities, and Table 400.5(A)(2) provides the ampacities for flexible cords and cables with not more than three current-carrying conductors. These tables shall be used in conjunction with applicable end-use product standards to ensure selection of the proper size and type. Where cords are used in ambient temperatures other than 30°C (86°F), the temperature correction factors from Table 310.15(B)(2)(a) that correspond to the temperature rating of the cord shall be applied to the ampacity in Table 400.5(A)(2). Where the number of current-carrying conductors exceeds three, the allowable ampacity or the ampacity of each conductor shall be reduced from the 3-conductor rating as shown in Table 400.5(A)(3).

Table 400.5(A)(1) Allowable Ampacity for Flexible Cords and Cables [Based on Ambient Temperature of 30°C (86°F). See 400.13 and Table 400.4.]

Copper Conductor Size (AWG)	Thermoplastic Types TPT, TST	Thermoset Types C, E, EO, PD, S, SJ, SJO, SJOW, SJOO, SJOOW, SO, SOW, SOO, SOOW, SP-1, SP-2, SP-3, SRD, SV, SVO, SVOO		Types HPD, HPN, HSJ, HSJO, HSJOO
		Column A*	Column B*	
27*	0.5	—	—	—
20	—	5**	***	—
18	—	7	10	10
17	—	9	12	13
16	—	10	13	15
15	—	12	16	17
14	—	15	18	20
12	—	20	25	30
10	—	25	30	35
8	—	35	40	—
6	—	45	55	—
4	—	60	70	—
2	—	80	95	—

*Tinsel cord.
 **Elevator cables only.
 ***7 amperes for elevator cables only; 2 amperes for other types.
 +The allowable currents under Column A apply to 3-conductor cords and other multiconductor cords connected to utilization equipment so that only 3 conductors are current-carrying. The allowable currents under Column B apply to 2-conductor cords and other multiconductor cords connected to utilization equipment so that only 2 conductors are current-carrying.

Table 400.5(A)(2) Ampacity of Cable Types SC, SCE, SCT, PPE, G, G-GC, and W. (Based on Ambient Temperature of 30°C (86°F). See Table 400.4.)

Copper Conductor Size (AWG or kcmil)	Temperature Rating of Cable								
	60°C (140°F)			75°C (167°F)			90°C (194°F)		
	D ¹	E ²	F ³	D ¹	E ²	F ³	D ¹	E ²	F ³
12	—	31	26	—	37	31	—	42	35
10	—	44	37	—	52	43	—	59	49
8	60	55	48	70	65	57	80	74	65
6	80	72	63	95	88	77	105	99	87
4	105	96	84	125	115	101	140	130	114
3	120	113	99	145	135	118	165	152	133
2	140	128	112	170	152	133	190	174	152
1	165	150	131	195	178	156	220	202	177
<hr/>									
1/0	195	171	151	230	207	181	260	234	205
2/0	225	199	174	265	238	208	300	271	237
3/0	260	230	201	310	275	241	350	313	274
4/0	300	265	232	360	317	277	405	361	316
<hr/>									
250	340	296	259	405	354	310	455	402	352
300	375	330	289	445	395	346	505	449	393
350	420	363	318	505	435	381	570	495	433
400	455	392	343	545	469	410	615	535	468
500	515	448	392	620	537	470	700	613	536
600	575	—	—	690	—	—	780	—	—
700	630	—	—	755	—	—	855	—	—
750	655	—	—	785	—	—	885	—	—
800	680	—	—	815	—	—	920	—	—
900	730	—	—	870	—	—	985	—	—
1000	780	—	—	935	—	—	1055	—	—

¹The ampacities under subheading D shall be permitted for single-conductor Types SC, SCE, SCT, PPE, and W cable only where the individual conductors are not installed in raceways and are not in physical contact with each other except in lengths not to exceed 600 mm (24 in.) where passing through the wall of an enclosure.

²The ampacities under subheading E apply to two-conductor cables and other multiconductor cables connected to utilization equipment so that only two conductors are current-carrying.

³The ampacities under subheading F apply to three-conductor cables and other multiconductor cables connected to utilization equipment so that only three conductors are current-carrying.

NEC 2011

Table 400.5(A)(3) Adjustment Factors for More Than Three Current-Carrying Conductors in a Flexible Cord or Cable

Number of Conductors	Percent of Value in Tables 400.5(A) and 400.5(B)
4–6	80
7–9	70
10–20	50
21–30	45
31–40	40
41 and above	35

NEC 2011

Informational Note: See Informative Annex B, Table B.310.15(B)(2)(11), for adjustment factors for more than three current-carrying conductors in a raceway or cable with load diversity.

A neutral conductor that carries only the unbalanced current from other conductors of the same circuit shall not be required to meet the requirements of a current-carrying conductor.

In a 3-wire circuit consisting of two phase conductors and the neutral conductor of a 4-wire, 3-phase, wye-connected system, a common conductor carries approximately the same current as the line-to-neutral currents of the other conductors and shall be considered to be a current-carrying conductor.

On a 4-wire, 3-phase, wye circuit where more than 50 percent of the load consists of nonlinear loads, there are harmonic currents present in the neutral conductor and the neutral conductor shall be considered to be a current-carrying conductor.

An equipment grounding conductor shall not be considered a current-carrying conductor.

Where a single conductor is used for both equipment grounding and to carry unbalanced current from other conductors, as provided for in 250.140 for electric ranges and electric clothes dryers, it shall not be considered as a current-carrying conductor.

Changed From NEC 2008

400.5(B) Ultimate Insulation Temperature: Relocated requirements covering neutral conductors and equipment grounding conductors to 400.5(A). Relocated exception permitting calculations per 310.15(C) to new 400.5(C).

NEC Language

(B) **Ultimate Insulation Temperature.** In no case shall conductors be associated together in such a way with respect to the kind of circuit, the wiring method used, or the number of conductors such that the limiting temperature of the conductors is exceeded.

(C) **Engineering Supervision.** Under engineering supervision, conductor ampacities shall be permitted to be calculated in accordance with 310.15(C).

400.7 Uses Permitted

NEC Language

(A) **Uses.** Flexible cords and cables shall be used only for the following

- (1) Pendants
- (2) Wiring of luminaires
- (3) Connection of portable luminaires, portable and mobile signs, or appliances
- (4) Elevator cables
- (5) Wiring of cranes and hoists
- (6) Connection of utilization equipment to facilitate frequent interchange
- (7) Prevention of the transmission of noise or vibration
- (8) Appliances where the fastening means and mechanical connections are specifically designed to permit ready removal for maintenance and repair, and the appliance is intended or identified for flexible cord connection

(9) Connection of moving parts

(10) Where specifically permitted elsewhere in this Code

Changed From NEC 2008

400.7(B) **Attachment Plugs**: This was revised to include cord connector bodies as a connection point to energize attachment plugs.

NEC Language

(B) **Attachment Plugs**. Where used as permitted in 400.7(A)(3), (A)(6), and (A)(8), each flexible cord shall be equipped with an attachment plug and shall be energized from a receptacle outlet or cord connector body.

Exception: As permitted in 368.56.

II. Construction Specifications

400.21 Construction

Changed From NEC 2008

400.21(A) & (B): This was revised to incorporate construction requirements from former 400.12. The exception to former 400.12 has been deleted.

NEC Language

(A) **Conductors**. The individual conductors of a flexible cord or cable shall have flexible stranding and shall not be smaller than the sizes specified in Table 400.4.

(B) **Nominal Insulation Thickness**. The nominal thickness of insulation for conductors of flexible cords and cables shall not be less than specified in Table 400.4.

III. Portable Cables Over 600 Volts, Nominal

400.31 Construction

(A) **Conductors**. The conductors shall be 12 AWG copper or larger and shall employ flexible stranding.

Changed From NEC 2008

400.31(B) **Equipment Grounding Conductor(s)**: Deleted requirement covering shielded flexible cables.

NEC Language

(B) **Equipment Grounding Conductor(s)**. An equipment grounding conductor(s) shall be provided. The total area shall not be less than that of the size of the equipment grounding conductor required in 250.122.

Article 404 — Switches

The requirements of Article 404 apply to switches of all types, including snap (toggle) switches, dimmer switches, circuit breakers used as switches, and automatic switches, such as time clocks and timers.

I. Installation

404.1 Scope

Changed From NEC 2008

404.1: This was revised to specify that requirements apply to equipment operating at 600 volts and below unless otherwise specified.

NEC Language

The provisions of this article apply to all switches, switching devices, and circuit breakers used as switches, operating at 600 volts and below, unless specifically referenced elsewhere in this Code for higher voltages.

404.2 Switch Connections

NEC Language

(A) **Three-Way and Four-Way Switches.** Three-way and four-way switches shall be wired so that all switching is done only in the ungrounded circuit conductor. Where in metal raceways or metal-armored cables, wiring between switches and outlets shall be in accordance with 300.20(A).

Exception: Switch loops shall not require a grounded conductor.

(B) **Grounded Conductors.** Switches or circuit breakers shall not disconnect the grounded conductor of a circuit.

Exception: A switch or circuit breaker shall be permitted to disconnect a grounded circuit conductor where all circuit conductors are disconnected simultaneously, or where the device is arranged so that the grounded conductor cannot be disconnected until all the ungrounded conductors of the circuit have been disconnected.

Changed From NEC 2008

404.2(C) **Switches Controlling Lighting Loads:** Added new requirement covering installation of grounded conductor at all switch locations where lighting loads are controlled. A grounded conductor is now required at most switch locations.

Highlight

To become more energy efficient, many companies have begun to install automatic lighting controls. As energy costs continue to rise and the government introduces energy saving initiatives, it is expected that these types of devices will be much more common.

In order for these devices to work properly, they must always be powered on so that they can sense motion and turn themselves on.

In many instances, these devices are installed as retrofits or in boxes that do not contain a grounded conductor for switches controlling lighting loads. Having no grounded conductor usually means that the installer is forced to use the grounding conductor as a means to carry this standby/operating current of the device.

This requirement will be that a where switches control lighting loads supplied by a grounded general purpose branch circuit, a grounded circuit conductor shall be provided at the switch location.

NEC Language

(C) Switches Controlling Lighting Loads. Where switches control lighting loads supplied by a grounded general purpose branch circuit, the grounded circuit conductor for the controlled lighting circuit shall be provided at the switch location.

Exception: The grounded circuit conductor shall be permitted to be omitted from the switch enclosure where either of the following conditions in (1) or (2) apply:

(1) Conductors for switches controlling lighting loads enter the box through a raceway. The raceway shall have sufficient cross-sectional area to accommodate the extension of the grounded circuit conductor of the lighting circuit to the switch location whether or not the conductors in the raceway are required to be increased in size to comply with 310.15(B)(3)(a).

(2) Cable assemblies for switches controlling lighting loads enter the box through a framing cavity that is open at the top or bottom on the same floor level, or through a wall, floor, or ceiling that is unfinished on one side.

Informational Note: The provision for a (future) grounded conductor is to complete a circuit path for electronic lighting control devices.

404.4 Damp or Wet Locations

The requirements for switches in damp or wet locations have been formatted into a list.

Changed From NEC 2008

404.4: This was revised editorially as three separate requirements by subdividing and adding new title to clearly identify the requirement for field marking.

NEC Language

(A) Surface-Mounted Switch or Circuit Breaker. A surface-mounted switch or circuit breaker shall be enclosed in a weatherproof enclosure or cabinet that shall comply with 312.2.

(B) Flush-Mounted Switch or Circuit Breaker. A flush-mounted switch or circuit breaker shall be equipped with a weatherproof cover.

(C) **Switches in Tub or Shower Spaces.** Switches shall not be installed within tubs or shower spaces unless installed as part of a listed tub or shower assembly.

404.8 Accessibility and Grouping

NEC Language

(A) **Location.** All switches and circuit breakers used as switches shall be located so that they may be operated from a readily accessible place. They shall be installed such that the center of the grip of the operating handle of the switch or circuit breaker, when in its highest position, is not more than 2.0 m (6 ft 7 in.) above the floor or working platform.

Exception No. 1: On busway installations, fused switches and circuit breakers shall be permitted to be located at the same level as the busway. Suitable means shall be provided to operate the handle of the device from the floor.

Exception No. 2: Switches and circuit breakers installed adjacent to motors, appliances, or other equipment that they supply shall be permitted to be located higher than 2.0 m (6 ft 7 in) and to be accessible by portable means.

Exception No. 3: Hookstick operable isolating switches shall be permitted at greater heights.

(B) **Voltage Between Adjacent Devices.** A snap switch shall not be grouped or ganged in enclosures with other snap switches, receptacles, or similar devices, unless they are arranged so that the voltage between adjacent devices does not exceed 300 volts, or unless they are installed in enclosures equipped with identified, securely installed barriers between adjacent devices.

(C) **Multipole Snap Switches.** A multipole, general-use snap switch shall not be permitted to be fed from more than a single circuit unless it is listed and marked as a two-circuit or three-circuit switch, or unless its voltage rating is not less than the nominal line-to-line voltage of the system supplying the circuits.

Changed From NEC 2008

404.8(C) **Informational Note:** Added new informational note referencing disconnecting means requirements in 210.7.

NEC Language

Informational Note: See 210.7 for disconnect requirements where more than one circuit supplies a switch.

404.9 Provisions for General-Use Snap Switches

NEC Language

(A) **Faceplates.** Faceplates provided for snap switches mounted in boxes and other enclosures shall be installed so as to completely cover the opening and, where the switch is flush mounted, seat against the finished surface.

(B) **Grounding.** Snap switches, including dimmer and similar control switches, shall be connected to an equipment grounding conductor and shall provide a means to connect metal faceplates to the equipment grounding conductor, whether or not a metal faceplate is installed. Snap switches shall be considered to be part of an effective ground-fault current path if either of the following conditions is met:

(1) The switch is mounted with metal screws to a metal box or metal cover that is connected to an equipment grounding conductor or to a nonmetallic box with integral means for connecting to an equipment grounding conductor.

(2) An equipment grounding conductor or equipment bonding jumper is connected to an equipment grounding termination of the snap switch.

Changed From NEC 2008

404.9(B) Exception No. 1: This was revised to specify proximity to ground or exposed grounded metal objects.

NEC Language

Exception No. 1 to (B): Where no means exists within the snap-switch enclosure for connecting to the equipment grounding conductor, or where the wiring method does not include or provide an equipment grounding conductor, a snap switch without a connection to an equipment grounding conductor shall be permitted for replacement purposes only. A snap switch wired under the provisions of this exception and located within 2.5 m (8 ft) vertically, or 1.5 m (5 ft) horizontally, of ground or exposed grounded metal objects shall be provided with a faceplate of nonconducting noncombustible material with nonmetallic attachment screws, unless the switch mounting strap or yoke is nonmetallic or the circuit is protected by a ground-fault circuit interrupter.

Changed From NEC 2008

404.9(B) Exception No. 2: Added new exception covering listed nonmetallic kits or assemblies.

NEC Language

Exception No. 2 to (B): Listed kits or listed assemblies shall not be required to be connected to an equipment grounding conductor if all of the following conditions are met:

- (1) The device is provided with a nonmetallic faceplate that cannot be installed on any other type of device,
- (2) The device does not have mounting means to accept other configurations of faceplates,
- (3) The device is equipped with a nonmetallic yoke, and
- (4) All parts of the device that are accessible after installation of the faceplate are manufactured of nonmetallic materials.

Changed From NEC 2008

404.9(B) Exception No. 3: Added new exception covering snap switches with an integral nonmetallic enclosure.

NEC Language

Exception No. 3 to (B): A snap switch with integral nonmetallic enclosure complying with 300.15(E) shall be permitted without a connection to an equipment grounding conductor.

Changed From NEC 2008

404.9(C) Construction: This was revised to provide correct thickness for faceplates constructed of insulating material.

NEC Language

(C) **Construction.** Metal faceplates shall be of ferrous metal not less than 0.76 mm (0.030 in.) in thickness or of nonferrous metal not less than 1.02 mm (0.040 in.) in thickness. Faceplates of insulating material shall be noncombustible and not less than 2.54 mm (0.100 in.) in thickness, but they shall be permitted to be less than 2.54 mm (0.100 in.) in thickness if formed or reinforced to provide adequate mechanical strength.

404.14 Rating and Use of Snap Switches**NEC Language**

Snap switches shall be used within their ratings and as indicated in 404.14(A) through (F).

Informational Note No. 1: For switches on signs and outline lighting, see 600.6.

Informational Note No. 2: For switches controlling motors, see 430.83, 430.109, and 430.110.

(A) **Alternating-Current General-Use Snap Switch.** A form of general-use snap switch suitable only for use on ac circuits for controlling the following:

- (1) Resistive and inductive loads not exceeding the ampere rating of the switch at the voltage involved
- (2) Tungsten-filament lamp loads not exceeding the ampere rating of the switch at 120 volts
- (3) Motor loads not exceeding 80 percent of the ampere rating of the switch at its rated voltage

(B) **Alternating-Current or Direct-Current General-Use Snap Switch.** A form of general-use snap switch suitable for use on either ac or dc circuits for controlling the following:

- (1) Resistive loads not exceeding the ampere rating of the switch at the voltage applied.
- (2) Inductive loads not exceeding 50 percent of the ampere rating of the switch at the applied voltage. Switches rated in horsepower are suitable for controlling motor loads within their rating at the voltage applied.
- (3) Tungsten-filament lamp loads not exceeding the ampere rating of the switch at the applied voltage if T-rated.

(C) **CO/ALR Snap Switches.** Snap switches rated 20 amperes or less directly connected to aluminum conductors shall be listed and marked CO/ALR.

(D) **Alternating-Current Specific-Use Snap Switches Rated for 347 Volts.** Snap switches rated 347 volts ac shall be listed and shall be used only for controlling the loads permitted by (D)(1) and (D)(2).

(1) **Noninductive Loads.** Noninductive loads other than tungsten-filament lamps not exceeding the ampere and voltage ratings of the switch.

(2) **Inductive Loads.** Inductive loads not exceeding the ampere and voltage ratings of the switch. Where particular load characteristics or limitations are specified as a condition of the listing, those restrictions shall be observed regardless of the ampere rating of the load.

The ampere rating of the switch shall not be less than 15 amperes at a voltage rating of 347 volts ac. Flush-type snap switches rated 347 volts ac shall not be readily interchangeable in box mounting with switches identified in 404.14(A) and (B).

(E) **Dimmer Switches.** General-use dimmer switches shall be used only to control permanently installed incandescent luminaires unless listed for the control of other loads and installed accordingly.

Changed From NEC 2008

404.14(F) Cord-and-Plug-Connected Loads: Added new requirement covering rating of snap switches controlling receptacle outlets or cord connectors that supply cord- and plug-connected loads.

NEC Language

(F) **Cord-and-Plug-Connected Loads.** Where a snap switch is used to control cord-and-plug-connected equipment on a general-purpose branch circuit, each snap switch controlling receptacle outlets or cord connectors that are supplied by permanently connected cord pendants shall be rated at not less than the rating of the maximum permitted ampere rating or setting of the overcurrent device protecting the receptacles or cord connectors, as provided in 210.21(B).

Informational Note: See 210.50(A) and 400.7(A)(1) for equivalency to a receptacle outlet of a cord connector that is supplied by a permanently connected cord pendant.

Exception: Where a snap switch is used to control not more than one receptacle on a branch circuit, the switch shall be permitted to be rated at not less than the rating of the receptacle.

Article 406 — Receptacles, Cord Connectors, and Attachment Plugs (Caps)

Article 406 covers the rating, type, and installation of receptacles, cord connectors, and attachment plugs (cord caps). It also addresses their grounding requirements. Some key points include:

- Follow the grounding requirements of the specific type of device you are using
- Provide GFCI protection where specified by 406.4(D)(3)
- Mount receptacles according to the requirements of 406.5 which are highly detailed.

406.2 Definition

Changed From NEC 2008

406.2 Child Care Facility: Added new definition to correlate with tamper-resistant receptacle requirement in 406.14.

NEC Language

Child Care Facility. A building or structure, or portion thereof, for educational, supervisory, or personal care services for more than four children 7 years old or less.

406.4 General Installation Requirements

Changed From NEC 2008

406.4 Receptacle outlets shall be located in branch circuits in accordance with Part III of Article 210. General installation requirements shall be in accordance with 406.4(A) through (F).

Basically, AFCI protection is now required for replacement receptacles that require AFCI protection elsewhere in the code.

NEC Language

(A) **Grounding Type.** Receptacles installed on 15- and 20-ampere branch circuits shall be of the grounding type. Grounding-type receptacles shall be installed only on circuits of the voltage class and current for which they are rated, except as provided in Table 210.21(B)(2) and Table 210.21(B)(3).

Exception: Nongrounding-type receptacles installed in accordance with 406.4(D).

(B) **To Be Grounded.** Receptacles and cord connectors that have equipment grounding conductor contacts shall have those contacts connected to an equipment grounding conductor.

Exception No. 1: Receptacles mounted on portable and vehicle-mounted generators in accordance with 250.34.

Exception No. 2: Replacement receptacles as permitted by 406.4(D).

(C) **Methods of Grounding.** The equipment grounding conductor contacts of receptacles and cord connectors shall be grounded by connection to the equipment grounding conductor of the circuit supplying the receptacle or cord connector.

Informational Note: For installation requirements for the reduction of electrical noise, see 250.146(D).

The branch-circuit wiring method shall include or provide an equipment grounding conductor to which the equipment grounding conductor contacts of the receptacle or cord connector are connected.

Informational Note No. 1: See 250.118 for acceptable grounding means.

Informational Note No. 2: For extensions of existing branch circuits, see 250.130.

(D) **Replacements.** Replacement of receptacles shall comply with 406.4(D)(1) through (D)(6), as applicable.

(1) **Grounding-Type Receptacles.** Where a grounding means exists in the receptacle enclosure or an equipment grounding conductor is installed in accordance with 250.130(C), grounding-type receptacles shall be used and shall be connected to the equipment grounding conductor in accordance with 406.4(C) or 250.130(C).

(2) **Non-Grounding-Type Receptacles.** Where attachment to an equipment grounding conductor does not exist in the receptacle enclosure, the installation shall comply with (D)(2)(a), (D)(2)(b), or (D)(2)(c).

(a) A non-grounding-type receptacle(s) shall be permitted to be replaced with another non-grounding-type receptacle(s).

(b) A non-grounding-type receptacle(s) shall be permitted to be replaced with a ground-fault circuit interrupter-type of receptacle(s). These receptacles shall be marked "No Equipment Ground." An equipment grounding conductor shall not be connected from the ground-fault circuit-interrupter-type receptacle to any outlet supplied from the ground-fault circuit-interrupter receptacle.

(c) A non-grounding-type receptacle(s) shall be permitted to be replaced with a grounding-type receptacle(s) where supplied through a ground-fault circuit interrupter. Grounding-type receptacles supplied through the ground-fault circuit interrupter shall be marked "GFCI Protected" and "No Equipment Ground." An equipment grounding conductor shall not be connected between the grounding-type receptacles.

(3) **Ground-Fault Circuit-Interrupters.** Ground-fault circuit-interrupter protected receptacles shall be provided where replacements are made at receptacle outlets that are required to be so protected elsewhere in this Code.

Changed From NEC 2008

406.4(D)(4) **Arc-Fault Circuit-Interrupter Protection:** Added new requirement covering replacement of a receptacle at a location where arc-fault circuit interruption protection of the branch circuit is required.

Highlight

406.4(D)(4), (5), & (6) Replacements - Receptacles

This new section requires that the replacement of receptacles should be made with types that would be required during new installations.

The intent will be to bring older installations up to the same requirements of the existing Code.

While these requirements are already in place for grounding, non-grounding, and GFCI receptacles, the Code making panels agreed that it makes sense to apply to other receptacle types as well.

It is now required to apply to Arc-Fault Circuit Interrupters 406.4(D)(4), Tamper-Resistant Receptacles 406.4(D)(5), and Weather-Resistant Receptacles 406.4(D)(6).

NEC Language

(4) Arc-Fault Circuit-Interrupter Protection. Where a receptacle outlet is supplied by a branch circuit that requires arc-fault circuit interrupter protection as specified elsewhere in this Code, a replacement receptacle at this outlet shall be one of the following:

- (1) A listed outlet branch circuit type arc-fault circuit interrupter receptacle
- (2) A receptacle protected by a listed outlet branch circuit type arc-fault circuit interrupter type receptacle
- (3) A receptacle protected by a listed combination type arc-fault circuit interrupter type circuit breaker

This requirement becomes effective January 1, 2014.

Changed From NEC 2008

406.4(D)(5) Tamper-Resistant Receptacles: Added new requirement covering replacement of a receptacle at a location where tamper-resistant receptacles are required.

NEC Language

(5) Tamper-Resistant Receptacles. Listed tamper-resistant receptacles shall be provided where replacements are made at receptacle outlets that are required to be tamper-resistant elsewhere in this Code.

Changed From NEC 2008

406.4(D)(6) Weather-Resistant Receptacles: Added new requirement covering replacement of a receptacle at a location where weather-resistant receptacles are required.

NEC Language

(6) Weather-Resistant Receptacles. Weather-resistant receptacles shall be provided where replacements are made at receptacle outlets that are required to be so protected elsewhere in this Code.

406.6 Receptacle Faceplates (Cover Plates)

Changed From NEC 2008

406.6: This was revised to provide a requirement on faceplate position where a faceplate is installed in a box to cover a recessed receptacle.

Receptacle faceplates shall be installed so as to completely cover the opening and seat against the mounting surface.

Receptacle faceplates mounted inside a box having a recess-mounted receptacle shall effectively close the opening and seat against the mounting surface.

(A) **Thickness of Metal Faceplates.** Metal faceplates shall be of ferrous metal not less than 0.76 mm (0.030 in.) in thickness or of nonferrous metal not less than 1.02 mm (0.040 in.) in thickness.

(B) **Grounding.** Metal faceplates shall be grounded.

(C) **Faceplates of Insulating Material.** Faceplates of insulating material shall be noncombustible and not less than 2.54 mm (0.10 in.) in thickness but shall be permitted to be less than 2.54 mm (0.10 in.) in thickness if formed or reinforced to provide adequate mechanical strength.

406.9 Receptacles in Damp or Wet Locations

NEC Language

(A) **Damp Locations.** A receptacle installed outdoors in a location protected from the weather or in other damp locations shall have an enclosure for the receptacle that is weatherproof when the receptacle is covered (attachment plug cap not inserted and receptacle covers closed).

An installation suitable for wet locations shall also be considered suitable for damp locations.

A receptacle shall be considered to be in a location protected from the weather where located under roofed open porches, canopies, marquees, and the like, and will not be subjected to a beating rain or water runoff. All 15- and 20-ampere, 125- and 250-volt nonlocking receptacles shall be a listed weather-resistant type.

Informational Note: The types of receptacles covered by this requirement are identified as 5-15, 5-20, 6-15, and 6-20 in ANSI/NEMA WD 6-2002, National Electrical Manufacturers Association Standard for Dimensions of Attachment Plugs and Receptacles.

Changed From NEC 2008

406.9(B) **Informational Note:** Added new informational note identifying product standard that covers "extra-duty" covers.

406.9(B) **Wet Locations:** This was revised to include requirement for listed outlet box "hoods" at other than one- and two-family dwellings.

NEC Language**(B) Wet Locations.**

(1) 15- and 20-Ampere Receptacles in a Wet Location. 15- and 20-ampere, 125- and 250-volt receptacles installed in a wet location shall have an enclosure that is weatherproof whether or not the attachment plug cap is inserted. For other than one- or two-family dwellings, an outlet box hood installed for this purpose shall be listed, and where installed on an enclosure supported from grade as described in 314.23(B) or as described in 314.23(F) shall be identified as "extra-duty." All 15- and 20-ampere, 125- and 250-volt nonlocking-type receptacles shall be listed weather-resistant type.

Informational Note No. 1: Requirements for extra-duty outlet box hoods are found in ANSI/UL 514D-2000, Cover Plates for Flush-Mounted Wiring Devices.

406.12 Tamper-Resistant Receptacles in Dwelling Units**Changed From NEC 2008**

406.12 & Exception: This was revised to specify that the requirement applies to "nonlocking" type receptacles and to add a new exception providing specific conditions under which receptacles are not required to be tamper-resistant

Highlight

The use of Tamper-Resistant receptacles in dwelling units was introduced into the 2008 version of the NEC. It states that receptacles in all areas of a dwelling unit specified by Article 210.52 be tamper proof.

The intent of this requirement is to provide safety to children by preventing foreign objects to be inserted into it.

While the requirement for the use of these receptacles is still present within the Code, there have are three new exceptions to this requirement.

Exception No.1 exempts receptacles that are located more than 1.7 m (5½ ft) above the floor.

Exception No. 2 exempts receptacles that are part of a luminaire or appliance.

Exception No. 3 exempts a single or duplex receptacle for two appliances located within a dedicated space, and would not be moved under normal use.

In other words appliances such as a refrigerator or dishwasher would not need to have a tamper-resistant receptacle installed behind them. These areas are not typically accessible by children.

NEC Language

In all areas specified in 210.52, all nonlocking-type 125-volt, 15- and 20-ampere receptacles shall be listed tamper-resistant receptacles.

Exception: Receptacles in the following locations shall not be required to be tamper-resistant:

- (1) Receptacles located more than 1.7 m (5½ ft) above the floor.
- (2) Receptacles that are part of a luminaire or appliance.
- (3) A single receptacle or a duplex receptacle for two appliances located within dedicated space for each appliance that, in normal use, is not easily moved from one place to another and that is cord-and-plug connected in accordance with 400.7(A)(6), (A)(7), or (A)(8).

(4) Nongrounding receptacles used for replacements as permitted in 406.4(D)(2)(a).

406.13 Tamper-Resistant Receptacles in Guest Rooms and Guest Suites ***Changed From NEC 2008***

406.13: The NEC added new requirement for tamper-resistant receptacles in guest rooms and guest suites in hotels and motels.

Highlight

406.13-14 Tamper-Resistant Receptacles

The primary purpose of the NEC is to provide direction to facilitate safe electrical installations.

While much of the focus is on fire prevention, it also has rules for the protection of electrical shock in adults and children.

Introduced in the 2008 NEC, tamper-resistant receptacles have been a requirement for all dwelling installations for new and remodeling work. These special receptacles will only open when an electrical plug of the correct type is inserted into them. This prevents a child or person from inserting a foreign object into it thereby reducing the risk of electrical shock.

In addition to the requirements for dwellings, this new section will require that all 125-volt, 15- and 20- ampere receptacles in guest rooms, guest suites, and child care facilities be of the tamper-proof type.

NEC Language

All nonlocking-type, 125-volt, 15- and 20-ampere receptacles located in guest rooms and guest suites shall be listed tamper-resistant receptacles.

406.14 Tamper-Resistant Receptacles in Child Care Facilities ***Changed From NEC 2008***

406.14: Added a new requirement for tamper-resistant receptacles in child care facilities.

NEC Language

In all child care facilities, all nonlocking-type, 125-volt, 15- and 20- ampere receptacles shall be listed tamper-resistant receptacles.

Article 408 — Switchboards and Panelboards

Article 408 covers the specific requirements for switchboards and panelboards that control power and lighting circuits. Some key points are:

- One objective of Article 408 is that the installation prevents contact between current-carrying conductors and people or equipment.
- The circuit directory of a panelboard must clearly identify the purpose or use of each circuit that originates in the panelboard.
- You must understand the detailed grounding and overcurrent protection requirements for panelboards.

I. General

408.1 Scope

Changed From NEC 2008

408.1: This was revised to specify that the requirements apply to equipment operating at 600 volts and below unless otherwise specified and to delete reference to distribution boards and battery-charging panels.

NEC Language

This article covers switchboards and panelboards. It does not apply to equipment operating at over 600 volts, except as specifically referenced elsewhere in the Code.

408.3 Support and Arrangement of Busbars and Conductors

NEC Language

(A) **Conductors and Busbars on a Switchboard or Panelboard.** Conductors and busbars on a switchboard or panelboard shall comply with 408.3(A)(1), (A)(2), and (A)(3) as applicable.

(1) **Location.** Conductors and busbars shall be located so as to be free from physical damage and shall be held firmly in place.

(2) **Service Switchboards.** Barriers shall be placed in all service switchboards such that no uninsulated, ungrounded service busbar or service terminal is exposed to inadvertent contact by persons or maintenance equipment while servicing load terminations.

(3) **Same Vertical Section.** Other than the required interconnections and control wiring, only those conductors that are intended for termination in a vertical section of a switchboard shall be located in that section.

Exception: Conductors shall be permitted to travel horizontally through vertical sections of switchboards where such conductors are isolated from busbars by a barrier.

(F) **Switchboard or Panelboard Identification.**

Changed From NEC 2008

408.3(F)(1) **High-Leg Identification:** Switchboards and panelboards containing ungrounded systems now require identification and field marking.

NEC Language

(1) **High-Leg Identification.** A switchboard or panelboard containing a 4-wire, delta-connected system where the midpoint of one phase winding is grounded shall be legibly and permanently field marked as follows:

"Caution _____ Phase Has _____ Volts to Ground"

Changed From NEC 2008

408.3(F)(2) Ungrounded Systems: Added new requirement covering field marking of a panelboard or switchboard containing conductors of an ungrounded electrical system.

NEC Language

(2) **Ungrounded Systems.** A switchboard or panelboard containing an ungrounded electrical system as permitted in 250.21 shall be legibly and permanently field marked as follows:

Caution Ungrounded System Operating — _____ Volts Between Conductors

(G) **Minimum Wire-Bending Space.** The minimum wire-bending space at terminals and minimum gutter space provided in panelboards and switchboards shall be as required in 312.6.

408.4 Field Identification Required.

Changed From NEC 2008

408.4(A) Circuit Directory or Circuit Identification: This was revised to include circuit breakers installed in switchboards that may or may not be used as a switch.

NEC Language

(A) **Circuit Directory or Circuit Identification.** Every circuit and circuit modification shall be legibly identified as to its clear, evident, and specific purpose or use. The identification shall include sufficient detail to allow each circuit to be distinguished from all others. Spare positions that contain unused overcurrent devices or switches shall be described accordingly. The identification shall be included in a circuit directory that is located on the face or inside of the panel door in the case of a panelboard, and located at each switch or circuit breaker in a switchboard. No circuit shall be described in a manner that depends on transient conditions of occupancy.

Changed From NEC 2008

408.4(B) Source of Supply: Added new requirement to mark where power source originates on switchboards and panelboards that are supplied by a feeder.

Highlight

New in the edition is a requirements that all switchboards and panelboards supplied by a feeder in other than one- or two- family dwellings shall be marked as to where the power supply originates. This currently is the common practice for newly constructed buildings as a part of the engineering design and deliverables. The requirement to do this reduces the amount of time to trace a panel feed back to its source in case of maintenance or emergencies.

NEC Language

(B) **Source of Supply.** All switchboards and panelboards supplied by a feeder in other than one- or two-family dwellings shall be marked to indicate the device or equipment where the power supply originates.

III. Panelboards

408.30 General

Changed From NEC 2008

408.30: This was revised by deleting reference to Part II of Article 220 covering branch circuit calculations.

NEC Language

All panelboards shall have a rating not less than the minimum feeder capacity required for the load calculated in accordance with Part III, IV, or V of Article 220, as applicable.

Informational Note: See 110.22 for additional requirements.

Article 409 — Industrial Control Panels

This article covers industrial control panels intended for general use and operating at 600 volts or less.

Informational Note: UL 508A-2001, Standard for Industrial Control Panels, is a safety standard for industrial control panels.

Article 409 provides installation and construction requirements for industrial control panels. These field- and factory-assembled control panels are used for the control and operation of a multitude of processes, from a sewerage pump station to an industrial process line. Similar in function to motor control centers in some regards, control panels also contain control, overcurrent protection, and power distribution equipment for operation of industrial heating processes, robotics, spray painting and powder coating lines, and countless other processes.

II. Installation

409.22 Short-Circuit Current Rating

Changed From NEC 2008

409.22: This was revised to prohibit installation at locations having available fault current exceeding short-circuit current rating of industrial control panel.

NEC Language

An industrial control panel shall not be installed where the available fault current exceeds its short-circuit current rating as marked in accordance with 409.110(4).

III. Construction Specifications

409.102 Busbars and Conductors

Changed From NEC 2008

409.102 For existing industrial control panels, other busbar arrangements (other than left to right, top to bottom, and so forth) are permitted as long as the busbar phases are permanently marked.

NEC Language

Industrial control panels utilizing busbars shall comply with 409.102(A) and (B).

(A) **Support and Arrangement.** Busbars shall be protected from physical damage and be held firmly in place.

Changed From NEC 2008

409.102(B) **Phase Arrangement:** This was revised to require permanent marking of phases where buses are arranged other than A, B, and C.

NEC Language

(B) **Phase Arrangement.** The phase arrangement on 3-phase horizontal common power and vertical buses shall be A, B, C from front to back, top to bottom, or left to right, as viewed from the front of the industrial control panel. The B phase shall be that phase having the higher voltage to ground on 3-phase, 4-wire, delta-connected systems. Other busbar arrangements shall be permitted for additions to existing installations, and the phases shall be permanently marked.

409.104 Wiring Space**Changed From NEC 2008**

409.104(A) **General:** This was revised to include conductors that tap off to supply other equipment.

Other equipment (other than switches or overcurrent devices) is permitted to be installed in industrial control panels with adequate wire bending space provided.

NEC Language

(A) **General.** Industrial control panel enclosures shall not be used as junction boxes, auxiliary gutters, or raceways for conductors feeding through or tapping off to other switches or overcurrent devices or other equipment, unless the conductors fill less than 40 percent of the cross-sectional area of the wiring space. In addition, the conductors, splices, and taps shall not fill the wiring space at any cross section to more than 75 percent of the cross-sectional area of that space.

409.110 Marking**NEC Language**

An industrial control panel shall be marked with the following information that is plainly visible after installation.

- (1) Manufacturer's name, trademark, or other descriptive marking by which the organization responsible for the product can be identified.
- (2) Supply voltage, number of phases, frequency, and full-load current for each incoming supply circuit.

Changed From NEC 2008

409.110(3): Added new marking requirement for industrial control panels that require operation of more than one disconnecting means to disconnect all power.

NEC Language

(3) Industrial control panels supplied by more than one power source such that more than one disconnecting means is required to disconnect all power within the control panel shall be marked to indicate that more than one disconnecting means is required to de-energize the equipment.

Items (4) through (7) *unchanged*.

Article 410 — Luminaires, Lampholders, and Lamps

Article 410 covers luminaires, lampholders, lamps, decorative lighting products, lighting accessories for temporary seasonal and holiday use, including portable flexible lighting products, and the wiring and equipment of such products and lighting installations. Article 410 is highly detailed and is broken down into 16 parts.

Changed From NEC 2008

410.76 through 410.79, 410.85, 410.86, 410.100, & 410.102: Requirements covering construction of luminaires deleted as such requirements are covered by 410.6.

II. Luminaire Locations**410.16 Luminaires in Clothes Closets****NEC Language**

(A) **Luminaire Types Permitted.** Only luminaires of the following types shall be permitted in a closet.

Changed From NEC 2008

410.16(A)(1): This was revised to include LED luminaires. The revisions were added to clearly permit surface-mounted LED luminaires in clothes closets.

NEC Language

(1) Surface-mounted or recessed incandescent or *LED luminaires* with completely enclosed light sources

(2) Surface-mounted or recessed fluorescent luminaires

(3) Surface-mounted fluorescent or LED luminaires identified as suitable for installation within the closet storage space

III. Provisions at Luminaire Outlet Boxes, Canopies, and Pans

410.20 Space for Conductors

Changed From NEC 2008

410.20: This was revised to include reference to 314.16 for sufficient wiring space.

NEC Language

Canopies and outlet boxes taken together shall provide sufficient space so that luminaire conductors and their connecting devices are capable of being installed in accordance with 314.16.

410.24 Connection of Electric-Discharge and LED Luminaires

Changed From NEC 2008

410.24: This was revised to include LED luminaires.

NEC Language

(A) **Independent of the Outlet Box.** Electric-discharge and LED luminaires supported independently of the outlet box shall be connected to the branch circuit through metal raceway, nonmetallic raceway, Type MC cable, Type AC cable, Type MI cable, nonmetallic sheathed cable, or by flexible cord as permitted in 410.62(B) or 410.62(C).

(B) **Access to Boxes.** Electric-discharge and LED luminaires surface mounted over concealed outlet, pull, or junction boxes and designed not to be supported solely by the outlet box shall be provided with suitable openings in the back of the luminaire to provide access to the wiring in the box.

V. Grounding

410.42 Luminaire(s) with Exposed Conductive Parts

Changed From NEC 2008

410.42, 410.44, & 410.46: Reorganized grounding requirements for luminaires. Former 410.42(B) relocated as 410.44 Exception No. 1.

NEC Language

Exposed metal parts shall be connected to an equipment grounding conductor or insulated from the equipment grounding conductor and other conducting surfaces or be inaccessible to unqualified personnel. Lamp tie wires, mounting screws, clips, and decorative bands on glass spaced at least 38 mm (1½ in.) from lamp terminals shall not be required to be grounded.

VI. Wiring of Luminaires

410.62 Cord-Connected Lampholders and Luminaires

NEC Language

(A) **Lampholders.** Where a metal lampholder is attached to a flexible cord, the inlet shall be equipped with an insulating bushing that, if threaded, is not smaller than metric designator 12 (trade size) pipe size. The cord hole shall be of a size appropriate for the cord, and all burrs and fins shall be removed in order to provide a smooth bearing surface for the cord.

Bushing having holes 7 mm (in.) in diameter shall be permitted for use with plain pendant cord and holes 11 mm (in.) in diameter with reinforced cord.

(B) **Adjustable Luminaires.** Luminaires that require adjusting or aiming after installation shall not be required to be equipped with an attachment plug or cord connector, provided the exposed cord is of the hard-usage or extra-hard-usage type and is not longer than that required for maximum adjustment. The cord shall not be subject to strain or physical damage.

Changed From NEC 2008

410.62(C) **Electric-Discharge and LED Luminaires:** The NEC added provision to include LED luminaires.

NEC Language

(C) **Electric-Discharge and LED Luminaires.**

410.64 Luminaires as Raceways

Changed From NEC 2008

410.64 : Revise and reorganized requirements covering luminaires used as a raceway. Former 410.65 relocated as 410.64(C).

NEC Language

Luminaires shall not be used as a raceway for circuit conductors unless they comply with 410.64(A), (B), or (C).

(A) **Listed.** Luminaires listed and marked for use as a raceway shall be permitted to be used as a raceway.

(B) **Through-Wiring.** Luminaires identified for through-wiring, as permitted by 410.21, shall be permitted to be used as a raceway.

(C) **Luminaires Connected Together.** Luminaires designed for end-to-end connection to form a continuous assembly, or luminaires connected together by recognized wiring methods, shall be permitted to contain the conductors of a 2-wire branch circuit, or one multiwire branch circuit, supplying the connected luminaires and shall not be required to be listed as a raceway. One additional 2-wire branch circuit separately supplying one or more of the connected luminaires shall also be permitted.

Informational Note: See Article 100 for the definition of Multiwire Branch Circuit.

410.68 Feeder and Branch-Circuit Conductors and Ballasts

Changed From NEC 2008

410.68: This was revised to include LED drivers, power supplies and transformers.

NEC Language

Feeder and branch-circuit conductors within 75 mm (3 in.) of a ballast, LED driver, power supply, or transformer shall have an insulation temperature rating not lower than 90°C (194°F), unless supplying a luminaire marked as suitable for a different insulation temperature.

VII. Construction of Luminaires

410.74 Luminaire Rating

Changed From NEC 2008

410.74: This was revised to include LED drivers and power supplies.

NEC Language

(A) **Marking.** All luminaires shall be marked with the maximum lamp wattage or electrical rating, manufacturer's name, trademark, or other suitable means of identification. A luminaire requiring supply wire rated higher than 60°C (140°F) shall be marked with the minimum supply wire temperature rating on the luminaire and shipping carton or equivalent.

(B) **Electrical Rating.** The electrical rating shall include the voltage and frequency and shall indicate the current rating of the unit, including the ballast, transformer, LED driver, power supply, or autotransformer.

410.96 Lampholders in Wet or Damp Locations

Changed From NEC 2008

410.96: This was revised to clarify the use of lampholders based on the location where they are installed.

NEC Language

Lampholders installed in wet locations shall be listed for use in wet locations. Lampholders installed in damp locations shall be listed for damp locations or shall be listed for wet locations.

410.97 Lampholders Near Combustible Material

Changed From NEC 2008

410.97: Added new requirement covering lampholders near combustible material.

NEC Language

Lampholders shall be constructed, installed, or equipped with shades or guards so that combustible material is not subjected to temperatures in excess of 90°C (194°F).

X. Special Provisions for Flush and Recessed Luminaires**410.110 General****Changed From NEC 2008**

410.110: This was revised to include specific reference to suspended ceilings.

NEC Language

Luminaires installed in recessed cavities in walls or ceilings, including suspended ceilings, shall comply with 410.115 through 410.122.

XI. Construction of Flush and Recessed Luminaires**410.122 Lampholders****Changed From NEC 2008**

410.122: This was revised to delete provision for high-heat type cements.

NEC Language

Lampholders of the screw shell type shall be of porcelain or other suitable insulating materials.

XII. Special Provisions for Electric-Discharge Lighting Systems of 1000 Volts or Less**410.130 General****NEC Language**

(A) **Open-Circuit Voltage of 1000 Volts or Less.** Equipment for use with electric-discharge lighting systems and designed for an open-circuit voltage of 1000 volts or less shall be of a type identified for such service.

(B) **Considered as Energized.** The terminals of an electric-discharge lamp shall be considered as energized where any lamp terminal is connected to a circuit of over 300 volts.

(C) **Transformers of the Oil-Filled Type.** Transformers of the oil-filled type shall not be used.

(D) **Additional Requirements.** In addition to complying with the general requirements for luminaires, such equipment shall comply with Part XIII of this article.

(E) **Thermal Protection — Fluorescent Luminaires.**

(1) **Integral Thermal Protection.** The ballast of a fluorescent luminaire installed indoors shall have integral thermal protection. Replacement ballasts shall also have thermal protection integral with the ballast.

- (2) **Simple Reactance Ballasts.** A simple reactance ballast in a fluorescent luminaire with straight tubular lamps shall not be required to be thermally protected.
- (3) **Exit Luminaires.** A ballast in a fluorescent exit luminaire shall not have thermal protection.
- (4) **Egress Luminaires.** A ballast in a fluorescent luminaire that is used for egress lighting and energized only during a failure of the normal supply shall not have thermal protection.

(F) High-Intensity Discharge Luminaires.

- (1) **Recessed.** Recessed high-intensity luminaires designed to be installed in wall or ceiling cavities shall have thermal protection and be identified as thermally protected.
- (2) **Inherently Protected.** Thermal protection shall not be required in a recessed high-intensity luminaire whose design, construction, and thermal performance characteristics are equivalent to a thermally protected luminaire and are identified as inherently protected.
- (3) **Installed in Poured Concrete.** Thermal protection shall not be required in a recessed high-intensity discharge luminaire identified for use and installed in poured concrete.
- (4) **Recessed Remote Ballasts.** A recessed remote ballast for a high-intensity discharge luminaire shall have thermal protection that is integral with the ballast and shall be identified as thermally protected.
- (5) **Metal Halide Lamp Containment.** Luminaires that use a metal halide lamp other than a thick-glass parabolic reflector lamp (PAR) shall be provided with a containment barrier that encloses the lamp, or shall be provided with a physical means that only allows the use of a lamp that is Type O.

Informational Note: See ANSI Standard C78.389, American National Standard for Electric Lamps — High Intensity Discharge, Methods of Measuring Characteristics.

Changed From NEC 2008

410.130(G) Disconnecting Means: This was revised to require installation of disconnecting means when ballasts are replaced in existing luminaires.

Highlight

In indoor locations other than dwelling units, fluorescent luminaires that use double-ended, ballast powered lamps, must have a disconnecting means either internal or external to the fixture.

The intent is to have a local disconnect that provides a margin of electrical safety while performing maintenance or replacing the ballast. This change requires that these disconnects be installed to existing lighting fixtures whenever the ballast is changed. These connectors are readily available and they can be easily installed in the field.

NEC Language

(G) Disconnecting Means.

- (1) **General.** In indoor locations other than dwellings and associated accessory structures, fluorescent luminaires that utilize double-ended lamps and contain ballast(s)

that can be serviced in place shall have a disconnecting means either internal or external to each luminaire. For existing installed luminaires without disconnecting means, at the time a ballast is replaced, a disconnecting means shall be installed. The line side terminals of the disconnecting means shall be guarded.

Exceptions 1 – 5 (No change in text)

410.136 Luminaire Mounting

Changed From NEC 2008

410.136(A) & (B): This was revised to include LED drivers and power supplies and to permit contact with combustible material where listed for the condition.

NEC Language

(A) **Exposed Components.** Luminaires that have exposed ballasts, transformers, LED drivers, or power supplies shall be installed such that ballasts, transformers, LED drivers, or power supplies shall not be in contact with combustible material unless listed for such condition.

(B) **Combustible Low-Density Cellulose Fiberboard.** Where a surface-mounted luminaire containing a ballast, transformer, LED driver, or power supply is to be installed on combustible low-density cellulose fiberboard, it shall be marked for this condition or shall be spaced not less than 38 mm (1½ in.) from the surface of the fiberboard. Where such luminaires are partially or wholly recessed, the provisions of 410.110 through 410.122 shall apply.

Informational Note: Combustible low-density cellulose fiberboard includes sheets, panels, and tiles that have a density of 320 kg/m³ (20 lb/ft³) or less and that are formed of bonded plant fiber material but does not include solid or laminated wood or fiberboard that has a density in excess of 320 kg/m³ (20 lb/ft³) or is a material that has been integrally treated with fire-retarding chemicals to the degree that the flame spread in any plane of the material will not exceed 25, determined in accordance with tests for surface burning characteristics of building materials. See ANSI/ASTM E84-1997, Test Method for Surface Burning Characteristics of Building Materials.

410.137 Equipment Not Integral with Luminaire

NEC Language

(A) **Metal Cabinets.** Auxiliary equipment, including reactors, capacitors, resistors, and similar equipment, where not installed as part of a luminaire assembly, shall be enclosed in accessible, permanently installed metal cabinets.

Changed From NEC 2008

410.137(B) **Separate Mounting:** This was revised to include LED drivers, power supplies and transformers and to specify equipment is to be listed for direct connection.

NEC Language

(B) **Separate Mounting.** Separately mounted ballasts, transformers, LED drivers, or power supplies that are listed for direct connection to a wiring system shall not be required to be additionally enclosed.

Article 422 — Appliances

Article 422 covers electric appliances used in any occupancy. The meat of this article is contained in parts II and III. Parts IV and V are primarily for manufacturers, however, it's important to examine appliances for compliance before installing them.

I. General

422.2 Definition

Changed From NEC 2008

422.2 Vending Machine: The definition was relocated from 422.51.

NEC Language

Vending Machine. Any self-service device that dispenses products or merchandise without the necessity of replenishing the device between each vending operation and is designed to require insertion of coin, paper currency, token, card, key, or receipt of payment by other means.

II. Installation

422.15 Central Vacuum Outlet Assemblies

NEC Language

(A) Listed central vacuum outlet assemblies shall be permitted to be connected to a branch circuit in accordance with 210.23(A).

(B) The ampacity of the connecting conductors shall not be less than the ampacity of the branch circuit conductors to which they are connected.

Changed From NEC 2008

422.15(C): This was revised to clarify metal parts that are not considered likely to become energized.

NEC Language

(C) Accessible non-current-carrying metal parts of the central vacuum outlet assembly likely to become energized shall be connected to an equipment grounding conductor in accordance with 250.110. Incidental metal parts such as screws or rivets installed into or on insulating material shall not be considered likely to become energized.

III. Disconnecting Means

422.30 General

Changed From NEC 2008

422.30: This was revised to clarify sources of power. Added “simultaneously” to the disconnecting means requirements for appliance.

NEC Language

A means shall be provided to **simultaneously** disconnect each appliance from all ungrounded conductors in accordance with the following sections of Part III. If an appliance is supplied by more than one branch-circuit or feeder, these disconnecting means shall be grouped and identified as the appliance disconnect.

422.31 Disconnection of Permanently Connected Appliances**Changed From NEC 2008**

Disconnecting means requirements when an appliance contains a motor over 1/8 hp has been revised and clarified.

NEC Language

(A) **Rated at Not over 300 Volt-Amperes or 1/8 Horsepower.** For permanently connected appliances rated at not over 300 volt-amperes or 1/8 hp, the branch-circuit overcurrent device shall be permitted to serve as the disconnecting means.

(B) **Appliances Rated over 300 Volt-Amperes or 1/8 Horsepower.** For permanently connected appliances rated over 300 volt-amperes or ~~1/8 hp~~, the branch-circuit switch or circuit breaker shall be permitted to serve as the disconnecting means where the switch or circuit breaker is within sight from the appliance or is capable of being locked in the open position. The provision for locking or adding a lock to the disconnecting means shall be installed on or at the switch or circuit breaker used as the disconnecting means and shall remain in place with or without the lock installed.

Informational Note: For appliances employing unit switches, see 422.34.

Changed From NEC 2008

422.31(C) **Motor-Operated Appliances Rated over 1/8 Horsepower:** Added new requirement covering motor-operated appliances rated over 1/8 hp to incorporate requirement formerly located in 422.31(B) and 422.32.

NEC Language

(C) **Motor-Operated Appliances Rated over 1/8 Horsepower.** For permanently connected motor-operated appliances with motors rated over 1/8 horse power, the branch-circuit switch or circuit breaker shall be permitted to serve as the disconnecting means where the switch or circuit breaker is within sight from the appliance. The disconnecting means shall comply with 430.109 and 430.110.

Exception: If an appliance of more than 1/8 hp is provided with a unit switch that complies with 422.34(A), (B), (C), or (D), the switch or circuit breaker serving as the other disconnecting means shall be permitted to be out of sight from the appliance.

Article 424 — Fixed Electric Space-Heating Equipment

This is a nine part article on space heaters. Because heaters come in various configurations for various uses, this article covers a variety of applications.

Fixed space heaters (wall-mounted, ceiling-mounted, or free-standing are common in many utility buildings and other small structures, as well as in some larger structures.

When used to heat floors, space-heating cables address the thermal layering problem typical of forced air systems – so it's likely you will come across them. Duct heaters are very common in large office and educational buildings. These provide distributed heating scheme. Locating the heater in the ductwork, but close to the occupied space, it eliminates the waste of transporting heated air from sheet metal routed in unheated spaces, so it is likely you will encounter those as well.

I. General

424.3 Branch Circuits

Changed From NEC 2008

424.3(A) Branch-Circuit Requirements: This was revised to require that an individual branch circuit be used within its rating.

NEC Language

(A) **Branch-Circuit Requirements.** Individual branch circuits shall be permitted to supply any volt-ampere or wattage rating of fixed electric space-heating equipment for which they are rated.

Branch circuits supplying two or more outlets for fixed electric space-heating equipment shall be rated 15, 20, 25, or 30 amperes. In other than a dwelling unit, fixed infrared heating equipment shall be permitted to be supplied from branch circuits rated not over 50 amperes.

(B) **Branch-Circuit Sizing.** Fixed electric space-heating equipment and motors shall be considered continuous load.

III. Control and Protection of Fixed Electric Space-Heating Equipment

424.19 Disconnecting Means

NEC Language

Means shall be provided to simultaneously disconnect the heater, motor controller(s), and supplementary overcurrent protective device(s) of all fixed electric space-heating equipment from all ungrounded conductors. Where heating equipment is supplied by more than one source, the disconnecting means shall be grouped and marked. The disconnecting means specified in 424.19(A) and (B) shall have an ampere rating not less than 125 percent of the total load of the motors and the heaters. The provision for locking or adding a lock to the disconnecting means shall be installed on or at the switch or circuit breaker used as the disconnecting means and shall remain in place with or without the lock installed.

(A) **Heating Equipment with Supplementary Overcurrent Protection.** The disconnecting means for fixed electric space-heating equipment with supplementary overcurrent protection shall be within sight from the supplementary overcurrent protective device(s), on the supply side of these devices, if fuses, and, in addition, shall comply with either 424.19(A)(1) or (A)(2).

(1) **Heater Containing No Motor Rated over 1/8 Horsepower.** The above disconnecting means or unit switches complying with 424.19(C) shall be permitted to serve as the

required disconnecting means for both the motor controller(s) and heater under either of the following conditions:

- (1) The disconnecting means provided is also within sight from the motor controller(s) and the heater.
- (2) The disconnecting means provided is capable of being locked in the open (off) position.

Changed From NEC 2008

424.19(A)(2) Heater Containing a Motor(s) Rated over 1/8 Horsepower: This was revised to correlate with requirements in 422.31(C) covering appliances with motors rated over 1/8 hp.

NEC Language

(2) **Heater Containing a Motor(s) Rated over 1/8 Horsepower.** The above disconnecting means shall be permitted to serve as the required disconnecting means for both the motor controller(s) and heater under either of the following conditions:

- (1) Where the disconnecting means is in sight from the motor controller(s) and the heater and complies with Part IX of Article 430.
- (2) Where a motor(s) of more than 1/8 hp and the heater are provided with a single unit switch that complies with 422.34(A), (B), (C), or (D), the disconnecting means shall be permitted to be out of sight from the motor controller.

IV. Marking of Heating Equipment

424.28 Nameplate

Changed From NEC 2008

424.28(A) Marking Required: This revised marking requirement to include heating equipment that is intended for use on ac and dc circuits.

NEC Language

(A) **Marking Required.** Each unit of fixed electric space-heating equipment shall be provided with a nameplate giving the identifying name and the normal rating in volts and watts or in volts and amperes.

Electric space-heating equipment intended for use on alternating current only, direct current only, or both shall be marked to so indicate. The marking of equipment consisting of motors over 1/8 hp and other loads shall specify the rating of the motor in volts, amperes, and frequency, and the heating load in volts and watts or in volts and amperes.

V. Electric Space-Heating Cables

424.39 Clearance from Other Objects and Openings

Changed From NEC 2008

Electric space-heating cables are not to be covered by the unit equipment.

NEC Language

Heating elements of cables shall be separated at least 200 mm (8 in.) from the edge of outlet boxes and junction boxes that are to be used for mounting surface luminaires. A clearance of not less than 50 mm (2 in.) shall be provided from recessed luminaires and their trims, ventilating openings, and other such openings in room surfaces. No heating cable shall be covered by any surface-mounted equipment.

424.44 Installation of Cables in Concrete or Poured Masonry Floors**NEC Language**

(A) **Watts per Linear Meter (Foot).** Constant wattage heating cables shall not exceed 54 watts per linear meter (16½ watts per linear foot) of cable.

(B) **Spacing Between Adjacent Runs.** The spacing between adjacent runs of cable shall not be less than 25 mm (1 in.) on centers.

(C) **Secured in Place.** Cables shall be secured in place by nonmetallic frames or spreaders or other approved means while the concrete or other finish is applied.

Cables shall not be installed where they bridge expansion joints unless protected from expansion and contraction.

(D) **Spacings Between Heating Cable and Metal Embedded in the Floor.** Spacings shall be maintained between the heating cable and metal embedded in the floor, unless the cable is a grounded metal-clad cable.

(E) **Leads Protected.** Leads shall be protected where they leave the floor by rigid metal conduit, intermediate metal conduit, rigid nonmetallic conduit, electrical metallic tubing, or by other approved means.

(F) **Bushings or Approved Fittings.** Bushings or approved fittings shall be used where the leads emerge within the floor slab.

Changed From NEC 2008

424.44(G) **Ground-Fault Circuit-Interrupter Protection:** This was revised to include electrically heated floors in kitchens.

NEC Language

(G) **Ground-Fault Circuit-Interrupter Protection.** Ground-fault circuit-interrupter protection for personnel shall be provided for cables installed in electrically heated floors of bathrooms, kitchens, and in hydromassage bathtub locations.

Article 426 — Fixed Outdoor Electric De-icing and Snow-Melting Equipment

The requirements of this article shall apply to electrically energized heating systems and the installation of these systems.

(A) **Embedded.** Embedded in driveways, walks, steps, and other areas.

(B) **Exposed.** Exposed on drainage systems, bridge structures, roofs, and other structures.

Article 426 includes requirements for resistance heating elements, impedance heating systems, or skin-effect heating systems used for deicing and snow melting. These systems are defined in 426.2.

I. General

426.2 Definitions

Changed From NEC 2008

“Dual-winding” has been changed to “isolation transformers” in 426.2 and 426.31. This was done because many transformers have more than two windings.

NEC Language

Heating System. A complete system consisting of components such as heating elements, fastening devices, nonheating circuit wiring, leads, temperature controllers, safety signs, junction boxes, raceways, and fittings.

Impedance Heating System. A system in which heat is generated in a pipe or rod, or combination of pipes and rods, by causing current to flow through the pipe or rod by direct connection to an ac voltage source from an isolating transformer. The pipe or rod shall be permitted to be embedded in the surface to be heated, or constitute the exposed components to be heated.

III. Resistance Heating Elements

426.20 Embedded Deicing and Snow-Melting Equipment

NEC Language

(A) **Watt Density.** Panels or units shall not exceed 1300 watts/m² (120 watts/ft²) of heated area.

(B) **Spacing.** The spacing between adjacent cable runs is dependent upon the rating of the cable and shall be not less than 25 mm (1 in.) on centers.

(C) **Cover.** Units, panels, or cables shall be installed as follows:

- (1) On a substantial asphalt or masonry base at least 50 mm (2 in.) thick and have at least 38 mm (1½ in.) of asphalt or masonry applied over the units, panels, or cables; or
- (2) They shall be permitted to be installed over other approved bases and embedded within 90 mm (3½ in.) of masonry or asphalt but not less than 38 mm (1½ in.) from the top surface; or

Changed From NEC 2008

426.20(C)(3): This was revised to require that listed equipment be installed only for its identified application.

NEC Language

(3) Equipment that has been listed for other forms of installation shall be installed only in the manner for which it has been identified.

(D) **Secured.** Cables, units, and panels shall be secured in place by frames or spreaders or other approved means while the masonry or asphalt finish is applied.

(E) **Expansion and Contraction.** Cables, units, and panels shall not be installed where they bridge expansion joints unless provision is made for expansion and contraction.

426.28 Ground-Fault Protection of Equipment

Changed From NEC 2008

The elimination of ground-fault protection of fixed outdoor electric deicing and snow-melting equipment from mineral-insulated, metal-sheilded cable has been deleted

Ground-fault protection of equipment shall be provided for fixed outdoor electric deicing and snow-melting equipment, ~~except for equipment that employs mineral-insulated, metal shielded cable embedded in a noncombustible medium.~~

Article 430 — Motors, Motor Circuits, and Controllers

Article 430 contains the specific rules for conductor sizing, overcurrent protection, control circuit conductors, controllers, and disconnecting means for electric motors. The installation requirements for motor control centers are covered in Part VIII, and air conditioning and refrigeration equipment are covered in article 440.

Article 430 is one of the longest articles in the NEC. It's also one of the most complex, mainly because motors are also complex equipment. They are electrical and mechanical devices, but what makes motor applications complex is the fact that there are inductive loads with a high current demand at startup that is typically six or more times the running current. This makes overcurrent protection for motor applications necessarily different from the protection employed for other types of equipment.

I. General

430.6 Ampacity and Motor Rating Determination

NEC Language

The size of conductors supplying equipment covered by Article 430 shall be selected from the allowable ampacity tables in accordance with 310.15(B) or shall be calculated in accordance with 310.15(C). Where flexible cord is used, the size of the conductor shall be selected in accordance with 400.5. The required ampacity and motor ratings shall be determined as specified in 430.6(A), (B), (C), and (D).

(A) **General Motor Applications.** For general motor applications, current ratings shall be determined based on (A)(1) and (A)(2).

(1) **Table Values.** Other than for motors built for low speeds (less than 1200 RPM) or high torques, and for multispeed motors, the values given in Table 430.247, Table 430.248, Table 430.249, and Table 430.250 shall be used to determine the ampacity of conductors or ampere ratings of switches, branch-circuit short-circuit and ground-fault protection, instead of the actual current rating marked on the motor nameplate. Where a motor is marked in amperes, but not horsepower, the horsepower rating shall be assumed to be that corresponding to the value given in Table 430.247, Table

430.248, Table 430.249, and Table 430.250, interpolated if necessary. Motors built for low speeds (less than 1200 RPM) or high torques may have higher full-load currents, and multispeed motors will have full-load current varying with speed, in which case the nameplate current ratings shall be used.

Exception No. 1: Multispeed motors shall be in accordance with 430.22(A) and 430.52.

Exception No. 2: For equipment that employs a shaded-pole or permanent-split capacitor-type fan or blower motor that is marked with the motor type, the full load current for such motor marked on the nameplate of the equipment in which the fan or blower motor is employed shall be used instead of the horsepower rating to determine the ampacity or rating of the disconnecting means, the branch-circuit conductors, the controller, the branch-circuit short-circuit and ground-fault protection, and the separate overload protection. This marking on the equipment nameplate shall not be less than the current marked on the fan or blower motor nameplate.

Exception No. 3: For a listed motor-operated appliance that is marked with both motor horsepower and full-load current, the motor full-load current marked on the nameplate of the appliance shall be used instead of the horsepower rating on the appliance nameplate to determine the ampacity or rating of the disconnecting means, the branch-circuit conductors, the controller, the branch-circuit short-circuit and ground-fault protection, and any separate overload protection.

(2) **Nameplate Values.** Separate motor overload protection shall be based on the motor nameplate current rating.

(B) **Torque Motors.** For torque motors, the rated current shall be locked-rotor current, and this nameplate current shall be used to determine the ampacity of the branch-circuit conductors covered in 430.22 and 430.24, the ampere rating of the motor overload protection, and the ampere rating of motor branch-circuit short-circuit and ground-fault protection in accordance with 430.52(B).

Informational Note: For motor controllers and disconnecting means, see 430.83(D) and 430.110.

(C) **Alternating-Current Adjustable Voltage Motors.** For motors used in alternating-current, adjustable voltage, variable torque drive systems, the ampacity of conductors, or ampere ratings of switches, branch-circuit short-circuit and ground-fault protection, and so forth, shall be based on the maximum operating current marked on the motor or control nameplate, or both. If the maximum operating current does not appear on the nameplate, the ampacity determination shall be based on 150 percent of the values given in Table 430.249 and Table 430.250.

Changed From NEC 2008

430.6(D) Valve Actuator Motor Assemblies: Added new requirement covering use of nameplate full-load current for valve actuator motor assemblies.

NEC Language

(D) **Valve Actuator Motor Assemblies.** For valve actuator motor assemblies (VAMs), the rated current shall be the nameplate full-load current, and this current shall be used to determine the maximum rating or setting of the motor branch-circuit short-circuit and ground-fault protective device and the ampacity of the conductors.

430.12 Motor Terminal Housings

NEC Language

(A) **Material.** Where motors are provided with terminal housings, the housings shall be of metal and of substantial construction.

Changed From NEC 2008

430.12(A) **Exception:** This was revised by replacing “*nonburning*” with “*noncombustible*”.

NEC Language

Exception: In other than hazardous (classified) locations, substantial, nonmetallic, *noncombustible* housings shall be permitted, provided an internal grounding means between the motor frame and the equipment grounding connection is incorporated within the housing.

II. Motor Circuit Conductors

430.22 Single Motor

Changed From NEC 2008

430.22(A) **Direct-Current Motor-Rectifier Supplied:** This was revised to incorporate provisions in former exception and to clarify conductor sizing on the input side of the rectifier.

NEC Language

Conductors that supply a single motor used in a continuous duty application shall have an ampacity of not less than 125 percent of the motor full-load current rating, as determined by 430.6(A)(1), or not less than specified in 430.22(A) through (G).

(A) **Direct-Current Motor-Rectifier Supplied.** For dc motors operating from a rectified power supply, the conductor ampacity on the input of the rectifier shall not be less than 125 percent of the rated input current to the rectifier. For dc motors operating from a rectified single-phase power supply, the conductors between the field wiring output terminals of the rectifier and the motor shall have an ampacity of not less than the following percentages of the motor full-load current rating:

- (1) Where a rectifier bridge of the single-phase, half-wave type is used, 190 percent.
- (2) Where a rectifier bridge of the single-phase, full-wave type is used, 150 percent.

(B) **Multispeed Motor.** For a multispeed motor, the selection of branch-circuit conductors on the line side of the controller shall be based on the highest of the full-load current ratings shown on the motor nameplate. The ampacity of the branch-circuit conductors between the controller and the motor shall not be less than 125 percent of the current rating of the winding(s) that the conductors energize.

Changed From NEC 2008

430.22(C) Wye-Start, Delta-Run Motor: This was revised to clarify conductor sizing on the line and load side of a wye-start, delta-run controller.

NEC Language

(C) **Wye-Start, Delta-Run Motor.** For a wye-start, delta-run connected motor, the ampacity of the branch-circuit conductors on the line side of the controller shall not be less than 125 percent of the motor full-load current as determined by 430.6(A)(1). The ampacity of the conductors between the controller and the motor shall not be less than 72 percent of the motor full-load current rating as determined by 430.6(A)(1).

Informational Note: The individual motor circuit conductors of a wye-start, delta-run connected motor carry 58 percent of the rated load current. The multiplier of 72 percent is obtained by multiplying 58 percent by 1.25.

Changed From NEC 2008

430.22(G) Conductors for Small Motors: The NEC added new requirements for use of 18 AWG and 16 AWG conductors with small motors.

NEC Language

(G) **Conductors for Small Motors.** Conductors for small motors shall not be smaller than 14 AWG unless otherwise permitted in 430.22(G)(1) or (G)(2).

(1) **18 AWG Copper.** Where installed in a cabinet or enclosure, 18 AWG individual copper conductors, copper conductors that are part of a jacketed multiconductor cable assembly, or copper conductors in a flexible cord shall be permitted, under either of the following sets of conditions:

(1) Motor circuits with a full-load ampacity greater than 3.5 amperes or less than or equal to 5 amperes if all the following conditions are met:

- a. The circuit is protected in accordance with 430.52.
- b. The circuit is provided with maximum Class 10 overload protection in accordance with 430.32.
- c. Overcurrent protection is provided in accordance with 240.4(D)(1)(2).

(2) Motor circuits with a full-load ampacity of 3.5 amperes or less if all the following conditions are met:

- a. The circuit is protected in accordance with 430.52.
- b. The circuit is provided with maximum Class 20 overload protection in accordance with 430.32.
- c. Overcurrent protection is provided in accordance with 240.4(D)(1)(2).

(2) **16 AWG Copper.** Where installed in a cabinet or enclosure, 16 AWG individual copper conductors, copper conductors that are part of a jacketed multiconductor cable assembly, or copper conductors in a flexible cord shall be permitted under either of the following sets of conditions:

(1) Motor circuits with a full-load ampacity greater than 5.5 amperes and less than or equal to 8 amperes if all the following conditions are met:

- a. The circuit is protected in accordance with 430.52.
- b. The circuit is provided with maximum Class 10 overload protection in accordance with 430.32.
- c. Overcurrent protection is provided in accordance with 240.4(D)(2)(2).

(2) Motor circuits with a full-load ampacity of 5.5 amperes or less if all the following conditions are met:

- a. The circuit is protected in accordance with 430.52.
- b. The circuit is provided with maximum Class 20 overload protection in accordance with 430.32.
- c. Overcurrent protection is provided in accordance with 240.4(D)(2)(2).

430.24 Several Motors or a Motor(s) and Other Load(s)

Changed From NEC 2008

430.24: This was revised to specify load calculation requirements for non-motor loads.
--

NEC Language

Conductors supplying several motors, or a motor(s) and other load(s), shall have an ampacity not less than the sum of each of the following:

- (1) 125 percent of the full-load current rating of the highest rated motor, as determined by 430.6(A)
- (2) Sum of the full-load current ratings of all the other motors in the group, as determined by 430.6(A)
- (3) 100 percent of the noncontinuous non-motor load
- (4) 125 percent of the continuous non-motor load.

Informational Note: See Informative Annex D, Example No. D8.

Exception No. 1: Where one or more of the motors of the group are used for short-time, intermittent, periodic, or varying duty, the ampere rating of such motors to be used in the summation shall be determined in accordance with 430.22(E). For the highest rated motor, the greater of either the ampere rating from 430.22(E) or the largest continuous duty motor full-load current multiplied by 1.25 shall be used in the summation.

Exception No. 2: The ampacity of conductors supplying motor-operated fixed electric space-heating equipment shall comply with 424.3(B).

Exception No. 3: Where the circuitry is interlocked so as to prevent simultaneous operation of selected motors or other loads, the conductor ampacity shall be permitted to be based on the summation of the currents of the motors and other loads to be operated simultaneously that results in the highest total current.

III. Motor and Branch-Circuit Overload Protection

430.42 Motors on General-Purpose Branch Circuits

NEC Language

Overload protection for motors used on general-purpose branch circuits as permitted in Article 210 shall be provided as specified in 430.42(A), (B), (C), or (D).

(A) **Not over 1 Horsepower.** One or more motors without individual overload protection shall be permitted to be connected to a general-purpose branch circuit only where the installation complies with the limiting conditions specified in 430.32(B) and 430.32(D) and 430.53(A)(1) and (A)(2).

(B) **Over 1 Horsepower.** Motors of ratings larger than specified in 430.53(A) shall be permitted to be connected to general-purpose branch circuits only where each motor is protected by overload protection selected to protect the motor as specified in 430.32. Both the controller and the motor overload device shall be approved for group installation with the short-circuit and ground-fault protective device selected in accordance with 430.53.

Changed From NEC 2008

430.42(C) Cord-and-Plug-Connected: This was revised to include cord connectors as a means to supply cord- and plug-connected motors.

NEC Language

(C) **Cord-and-Plug-Connected.** Where a motor is connected to a branch circuit by means of an attachment plug and a receptacle or a cord connector, and individual overload protection is omitted as provided in 430.42(A), the rating of the attachment plug and receptacle or cord connector shall not exceed 15 amperes at 125 volts or 250 volts. Where individual overload protection is required as provided in 430.42(B) for a motor or motor-operated appliance that is attached to the branch circuit through an attachment plug and a receptacle or a cord connector, the overload device shall be an integral part of the motor or of the appliance. The rating of the attachment plug and receptacle or the cord connector shall determine the rating of the circuit to which the motor may be connected, as provided in 210.21(B).

(D) **Time Delay.** The branch-circuit short-circuit and ground-fault protective device protecting a circuit to which a motor or motor-operated appliance is connected shall have sufficient time delay to permit the motor to start and accelerate its load.

IV. Motor Branch-Circuit Short-Circuit and Ground-Fault Protection

430.52 Rating or Setting for Individual Motor Circuit

NEC Language

(A) **General.** The motor branch-circuit short-circuit and ground-fault protective device shall comply with 430.52(B) and either 430.52(C) or (D), as applicable.

(B) **All Motors.** The motor branch-circuit short-circuit and ground-fault protective device shall be capable of carrying the starting current of the motor.

(C) Rating or Setting.***Changed From NEC 2008***

430.52(C)(7) **Informational Note:** Added new informational note covering motor short-circuit protectors.

NEC Language

(7) Motor Short-Circuit Protector. A motor short-circuit protector shall be permitted in lieu of devices listed in Table 430.52 if the motor short-circuit protector is part of a listed combination motor controller having coordinated motor overload protection and short-circuit and ground-fault protection in each conductor and it will open the circuit at currents exceeding 1300 percent of motor full-load current for other than Design B energy-efficient motors and 1700 percent of motor full-load motor current for Design B energy-efficient motors.

Informational Note. A motor short-circuit protector, as used in this section, is a fused device and is not an instantaneous trip circuit breaker.

430.53 Several Motors or Loads on One Branch Circuit***Changed From NEC 2008***

430.53: This was revised to require use of fuses or inverse time circuit breakers.

Inverse time circuit breakers and fuses are the only permitted means for providing group motor branch-circuit short-circuit and ground-fault protection.

NEC Language

Two or more motors or one or more motors and other loads shall be permitted to be connected to the same branch circuit under conditions specified in 430.53(D) and in 430.53(A), (B), or (C). The branch-circuit protective device shall be fuses or inverse time circuit breakers.

(A) Not Over 1 Horsepower. Several motors, each not exceeding 1 hp in rating, shall be permitted on a nominal 120-volt branch circuit protected at not over 20 amperes or a branch circuit of 600 volts, nominal, or less, protected at not over 15 amperes, if all of the following conditions are met:

- (1) The full-load rating of each motor does not exceed 6 amperes.
- (2) The rating of the branch-circuit short-circuit and ground-fault protective device marked on any of the controllers is not exceeded.
- (3) Individual overload protection conforms to 430.32.

(B) If Smallest Rated Motor Protected. If the branch-circuit short-circuit and ground-fault protective device is selected not to exceed that allowed by 430.52 for the smallest rated motor, two or more motors or one or more motors and other load(s), with each motor having individual overload protection, shall be permitted to be connected to a branch circuit where it can be determined that the branch-circuit short-circuit and ground-fault protective device will not open under the most severe normal conditions of service that might be encountered.

(C) Other Group Installations. Two or more motors of any rating or one or more motors and other load(s), with each motor having individual overload protection, shall be permitted to be connected to one branch circuit where the motor controller(s) and overload device(s) are (1) installed as a listed factory assembly and the motor branch-circuit short-circuit and ground-fault protective device either is provided as part of the assembly or is specified by a marking on the assembly, or (2) the motor branch-circuit short-circuit and ground-fault protective device, the motor controller(s), and overload device(s) are field-installed as separate assemblies listed for such use and provided with manufacturers' instructions for use with each other, and (3) all of the following conditions are complied with:

Changed From NEC 2008

430.53(C)(1): This was revised to provide a second method for sizing the motor overload device.

NEC Language

(1) Each motor overload device is either (a) listed for group installation with a specified maximum rating of fuse, inverse time circuit breaker, or both, or (b) selected such that the ampere rating of the motor-branch short-circuit and ground-fault protective device does not exceed that permitted by 430.52 for that individual motor overload device and corresponding motor load.

Changed From NEC 2008

430.53(C)(2): This was revised to provide a second method for sizing the motor controller.

NEC Language

(2) Each motor controller is either (a) listed for group installation with a specified maximum rating of fuse, circuit breaker, or both, or (b) selected such that the ampere rating of the motor-branch short-circuit and ground-fault protective device does not exceed that permitted by 430.52 for that individual controller and corresponding motor load.

Items (3) through (6) text unchanged.

(D) Single Motor Taps. For group installations described above, the conductors of any tap supplying a single motor shall not be required to have an individual branch-circuit short-circuit and ground-fault protective device, provided they comply with one of the following:

(1) No conductor to the motor shall have an ampacity less than that of the branch-circuit conductors.

Changed From NEC 2008

430.53(D)(2): This was revised to specify the acceptable means of providing physical protection for tap conductors.

NEC Language

(2) No conductor to the motor shall have an ampacity less than one-third that of the branch-circuit conductors, with a minimum in accordance with 430.22, the conductors to the motor overload device being not more than 7.5 m (25 ft) long and being protected from physical damage by being enclosed in an approved raceway or by use of other approved means.

Changed From NEC 2008

430.53(D)(3): This was revised to expand the types of branch circuit protective devices to which tap conductors are permitted to be connected.

NEC Language

(3) Conductors from the branch-circuit short-circuit and ground-fault protective device to a listed manual motor controller additionally marked "Suitable for Tap Conductor Protection in Group Installations," or to a branch-circuit protective device, shall be permitted to have an ampacity not less than one-tenth the rating or setting of the branch-circuit short-circuit and ground-fault protective device. The conductors from the controller to the motor shall have an ampacity in accordance with 430.22. The conductors from the branch-circuit short-circuit and ground-fault protective device to the controller shall (1) be suitably protected from physical damage and enclosed either by an enclosed controller or by a raceway and be not more than 3 m (10 ft) long or (2) have an ampacity not less than that of the branch-circuit conductors.

V. Motor Feeder Short-Circuit and Ground-Fault Protection**430.63 Rating or Setting — Motor Load and Other Load(s)****Changed From NEC 2008**

430.63: This was revised to not limit "other loads" to lighting or appliances.

"Lighting loads" was replaced with "other loads" to indicate the rating of motor feeder short-circuit and ground-fault protection, for a motor load applies to more than lighting loads.

NEC Language

Where a feeder supplies a motor load and other load(s), the feeder protective device shall have a rating not less than that required for the sum of the other load(s) plus the following:

- (1) For a single motor, the rating permitted by 430.52
- (2) For a single hermetic refrigerant motor-compressor, the rating permitted by 440.22
- (3) For two or more motors, the rating permitted by 430.62

Exception: Where the feeder overcurrent device provides the overcurrent protection for a motor control center, the provisions of 430.94 shall apply.

VI. Motor Control Circuits

430.74 Electrical Arrangement of Control Circuits

Changed From NEC 2008

430.74: This was revised by replacing "ground" with "ground fault" in order to use a defined term.

NEC Language

Where one conductor of the motor control circuit is grounded, the motor control circuit shall be arranged so that a ground fault in the control circuit remote from the motor controller will (1) not start the motor and (2) not bypass manually operated shutdown devices or automatic safety shutdown devices.

VII. Motor Controllers

430.81 General

NEC Language

Part VII is intended to require suitable controllers for all motors.

(A) **Stationary Motor of 1/8 Horsepower or Less.** For a stationary motor rated at 1/8 hp or less that is normally left running and is constructed so that it cannot be damaged by overload or failure to start, such as clock motors and the like, the branch-circuit disconnecting means shall be permitted to serve as the controller.

Changed From NEC 2008

430.81(B) **Portable Motor of 1/3 Horsepower or Less:** This was revised to include cord connectors as a means to supply cord- and plug-connected motors.

NEC Language

(B) **Portable Motor of 1/3 Horsepower or Less.** For a portable motor rated at 1/3 hp or less, the controller shall be permitted to be an attachment plug and receptacle or cord connector.

VIII. Motor Control Centers

430.94 Overcurrent Protection

Changed From NEC 2008

430.94: This was revised to reference Part VIII of Article 240 covering supervised industrial installations.

NEC Language

Motor control centers shall be provided with overcurrent protection in accordance with Parts I, II, and VIII of Article 240. The ampere rating or setting of the overcurrent protective device shall not exceed the rating of the common power bus. This protection shall be provided by (1) an overcurrent protective device located ahead of the motor

control center or (2) a main overcurrent protective device located within the motor control center.

IX. Disconnecting Means

430.109 Type

NEC Language

The disconnecting means shall be a type specified in 430.109(A), unless otherwise permitted in 430.109(B) through (G), under the conditions specified.

(A) General.

- (1) **Motor Circuit Switch.** A listed motor-circuit switch rated in horsepower.
- (2) **Molded Case Circuit Breaker.** A listed molded case circuit breaker.
- (3) **Molded Case Switch.** A listed molded case switch.
- (4) **Instantaneous Trip Circuit Breaker.** An instantaneous trip circuit breaker that is part of a listed combination motor controller.
- (5) **Self-Protected Combination Controller.** Listed self-protected combination controller.
- (6) **Manual Motor Controller.** Listed manual motor controllers additionally marked "Suitable as Motor Disconnect" shall be permitted as a disconnecting means where installed between the final motor branch-circuit short-circuit protective device and the motor. Listed manual motor controllers additionally marked "Suitable as Motor Disconnect" shall be permitted as disconnecting means on the line side of the fuses permitted in 430.52(C)(5). In this case, the fuses permitted in 430.52(C)(5) shall be considered supplementary fuses, and suitable branch-circuit short-circuit and ground-fault protective devices shall be installed on the line side of the manual motor controller additionally marked "Suitable as Motor Disconnect."
- (7) **System Isolation Equipment.** System isolation equipment shall be listed for disconnection purposes. System isolation equipment shall be installed on the load side of the overcurrent protection and its disconnecting means. The disconnecting means shall be one of the types permitted by 430.109(A)(1) through (A)(3).

(B) **Stationary Motors of 1/8 Horsepower or Less.** For stationary motors of 1/8 hp or less, the branch-circuit overcurrent device shall be permitted to serve as the disconnecting means.

(C) **Stationary Motors of 2 Horsepower or Less.** For stationary motors rated at 2 hp or less and 300 volts or less, the disconnecting means shall be permitted to be one of the devices specified in (1), (2), or (3):

- (1) A general-use switch having an ampere rating not less than twice the full-load current rating of the motor
- (2) On ac circuits, a general-use snap switch suitable only for use on ac (not general-use ac–dc snap switches) where the motor full-load current rating is not more than 80 percent of the ampere rating of the switch

(3) A listed manual motor controller having a horsepower rating not less than the rating of the motor and marked "Suitable as Motor Disconnect"

(D) **Autotransformer-Type Controlled Motors.** For motors of over 2 hp to and including 100 hp, the separate disconnecting means required for a motor with an autotransformer-type controller shall be permitted to be a general-use switch where all of the following provisions are met:

(1) The motor drives a generator that is provided with overload protection.

(2) The controller is capable of interrupting the locked-rotor current of the motors, is provided with a no voltage release, and is provided with running overload protection not exceeding 125 percent of the motor full-load current rating.

(3) Separate fuses or an inverse time circuit breaker rated or set at not more than 150 percent of the motor full-load current is provided in the motor branch circuit.

(E) **Isolating Switches.** For stationary motors rated at more than 40 hp dc or 100 hp ac, the disconnecting means shall be permitted to be a general-use or isolating switch where plainly marked "Do not operate under load."

Changed From NEC 2008

430.109(F) **Cord-and-Plug-Connected Motors:** This was revised to include flanged inlets and cord connectors as means for disconnecting cord-and plug-connected motors.

NEC Language

(F) **Cord-and-Plug-Connected Motors.** For a cord-and-plug-connected motor, a horsepower-rated attachment plug and receptacle, flanged surface inlet and cord connector, or attachment plug and cord connector having ratings no less than the motor ratings shall be permitted to serve as the disconnecting means. Horsepower-rated attachment plugs, flanged surface inlets, receptacles, or cord connectors shall not be required for cord-and-plug-connected appliances in accordance with 422.33, room air conditioners in accordance with 440.63, or portable motors rated 1/3 hp or less.

(G) **Torque Motors.** For torque motors, the disconnecting means shall be permitted to be a general-use switch.

X. Adjustable-Speed Drive Systems

430.122 Conductors — Minimum Size and Ampacity

Changed From NEC 2008

430.122(A) **Branch/Feeder Circuit Conductors:** This was revised to clarify that the requirement applies to the rated input current.

NEC Language

(A) **Branch/Feeder Circuit Conductors.** Circuit conductors supplying power conversion equipment included as part of an adjustable-speed drive system shall have an ampacity not less than 125 percent of the rated input current to the power conversion equipment.

Informational Note: Power conversion equipment can have multiple power ratings and corresponding input currents.

XI. Over 600 Volts, Nominal

430.225 Motor-Circuit Overcurrent Protection

NEC Language

(A) **General.** Each motor circuit shall include coordinated protection to automatically interrupt overload and fault currents in the motor, the motor-circuit conductors, and the motor control apparatus.

Changed From NEC 2008

430.225(A) **Exception:** This was revised to apply to motors installed in locations other than a plant.

NEC Language

Exception: Where a motor is critical to an operation and the motor should operate to failure if necessary to prevent a greater hazard to persons, the sensing device(s) shall be permitted to be connected to a supervised annunciator or alarm instead of interrupting the motor circuit.

(B) **Overload Protection.**

Changed From NEC 2008

430.225(B)(1) **Type of Overload Device:** This was revised to require that a relay coordination study be conducted under engineering supervision.

Highlight

The change in this section applies to overload and short-circuit protective device sizing for motors that are over 600 volts.

Engineering supervision will now be required during the selection process.

A relay coordination study should be performed to correctly size the protective relaying or thermal protectors based on the motor damage curves under qualified engineering supervision.

Selecting the proper overload and short-circuit protection for medium voltage motor circuits is much more complicated than for low voltage circuits. For medium voltage motor circuits, it becomes very critical for the overload relay to coordinate with the short-circuit protection because some short-circuit protective devices cannot safely open below certain multiples of their rating. In these overload cases the overload relay must open before the short-circuit protective device is asked to open.

At the same time, the overload relay can not safely open beyond certain multiples of its rating, requiring the short-circuit protective device to open. This all requires the engineer to lay out the curves of both the overload relay and the short-circuit protective device and make sure that they are coordinated so that each opens only on levels of current for which it can safely open.

NEC Language

(1) **Type of Overload Device.** Each motor shall be protected against dangerous heating due to motor overloads and failure to start by a thermal protector integral with the motor or external current-sensing devices, or both. Protective device settings for each motor circuit shall be determined under engineering supervision.

XIII. Grounding — All Voltages

430.245 Method of Grounding.

NEC Language

Connection to the equipment grounding conductor shall be done in the manner specified in Part VI of Article 250.

Changed From NEC 2008

430.245(A) Grounding Through Terminal Housings: This was revised to provide specific references for grounding requirements.

NEC Language

(A) **Grounding Through Terminal Housings.** Where the wiring to motors is metal-enclosed cable or in metal raceways, junction boxes to house motor terminals shall be provided, and the armor of the cable or the metal raceways shall be connected to them in the manner specified in 250.96(A) and 250.97.

Informational Note: See 430.12(E) for equipment grounding connection means required at motor terminal housings.

Article 440 — Air-Conditioning and Refrigerating Equipment

Article 440 applies to electrically driven air conditioning and refrigeration equipment. The rules of this article add to, or amend, the rules in article 430 and other articles.

Each equipment manufacturer the motor for a given air-conditioning unit built to its own specifications. Cooling and other characteristics are different from those in nonhermetic motors. For each motor, the manufacturer has worked out all of the details and supplied the correct protection, conductor sizing, and other information on the nameplate. So when wiring an air conditioner, trust the information on the nameplate and don't try to over-complicate things. The math for sizing the overcurrent protection and conductor minimum capacity has already been done for you.

VI. Motor-Compressor and Branch-Circuit Overload Protection

440.55 Cord-and-Attachment-Plug-Connected Motor-Compressors and Equipment on 15- or 20-Ampere Branch Circuits

NEC Language

Overload protection for motor-compressors and equipment that are cord-and-attachment-plug-connected and used on 15- or 20-ampere 120-volt, or 15-ampere 208- or 240-volt, single-phase branch circuits as permitted in Article 210 shall be permitted as indicated in 440.55(A), (B), and (C).

(A) **Overload Protection.** The motor-compressor shall be provided with overload protection as specified in 440.52(A). Both the controller and the motor overload protective device shall be identified for installation with the short-circuit and ground-fault protective device for the branch circuit to which the equipment is connected.

Changed From NEC 2008

440.55(B) Attachment Plug and Receptacle or Cord Connector Rating: This was revised to include cord connectors as a method for supplying cord- and plug-connected motor compressors.

NEC Language

(B) Attachment Plug and Receptacle or Cord Connector Rating. The rating of the attachment plug and receptacle or cord connector shall not exceed 20 amperes at 125 volts or 15 amperes at 250 volts.

(C) Time Delay. The short-circuit and ground-fault protective device protecting the branch circuit shall have sufficient time delay to permit the motor-compressor and other motors to start and accelerate their loads.

VII. Provisions for Room Air Conditioners**440.63 Disconnecting Means****Changed From NEC 2008**

440.63: This was revised to include cord connectors as a method for supplying cord- and plug-connected room air conditioners.

NEC Language

An attachment plug and receptacle or cord connector shall be permitted to serve as the disconnecting means for a single-phase room air conditioner rated 250 volts or less if (1) the manual controls on the room air conditioner are readily accessible and located within 1.8 m (6 ft) of the floor, or (2) an approved manually operable disconnecting means is installed in a readily accessible location within sight from the room air conditioner.

Article — 445 Generators

This article contains the electrical installation, and other requirements, for generators. These requirements include such things as where generators can be installed, nameplate markings, conductor ampacity, and disconnecting means.

Generators are basically motors that operate in reverse – they produce electricity when rotated, instead of rotating when supplied with electricity. Article 430, which covers motors, is the longest article in the NEC. Article 445, which covers generators, is one of the shortest. At first this might not seem to make sense. But you don't need to size and protect conductors to a generator. You do need to size and protect them to a motor.

Generators need overload protection, and it's necessary to size the conductors that come from the generator. But these considerations are much more straightforward than the equivalent considerations for motors.

445.1 Scope**Changed From NEC 2008**

445.1: This was revised to indicate that the article contains installation and other requirements for generators.

NEC Language

This article contains installation and other requirements for generators.

445.12 Overcurrent Protection**Changed From NEC 2008**

445.12(A) Constant-Voltage Generators: This was revised to include protective relays or other identified overcurrent protective devices as means to protect generator.

NEC Language

(A) **Constant-Voltage Generators.** Constant-voltage generators, except ac generator exciters, shall be protected from overload by inherent design, circuit breakers, fuses, protective relays, or other identified overcurrent protective means suitable for the conditions of use.

445.19 Generators Supplying Multiple Loads**NEC Language**

A single generator supplying more than one load, or multiple generators operating in parallel, shall be permitted to supply either of the following:

- (1) A vertical switchboard with separate sections

Changed From NEC 2008

445.19(2): This was revised to require overcurrent protection complying with 240.15(A). This clarifies the application of tap conductors where multiple enclosures are supplied from a generator.

NEC Language

(2) Individual enclosures with overcurrent protection tapped from a single feeder for load separation and distribution if a generator(s) is provided with overcurrent protection meeting the requirements of 240.15(A).

Article 450 — Transformers and Transformer Vaults (Including Secondary Ties)

Article 450 essentially covers power transformers and most kinds of lighting transformers.

A major concern with transformers is preventing overheating. The Code does not completely address this issue. Article 90 explains that the NEC is not a design manual, and it assumes that the person using the code has a certain level of expertise. Proper transformer selection is an important part of preventing transformer overheating.

The NEC assumes you have already selected a transformer suitable to the load characteristics. For the Code to tell you how to do that would push it into the realm of a design manual. Article 450 then takes you to the next logical step – providing overcurrent protection and the proper connections, but this article does not stop there; 450.9 provides ventilation requirements, and 450.13 contains accessibility requirements.

Part I of article 450 contains the general requirements such as guarding, marking, and accessibility. Part II contains the requirements for different types of transformers, and part III covers transformer vaults.

I. General Provisions

450.14 Disconnecting Means

Changed From NEC 2008

450.14: Added new requirement covering disconnecting means for transformers other than Class 2 or Class 3 transformers.

Highlight

Transformers other than listed class 2 or class 3 are now required to have a disconnecting means.

This serves two main purposes. One it provides a measure of controllable safety to the personnel performing on the transformer or its circuits. It also allows for a means to isolate a transformer that is being fed from a common feeder supplying other transformers. In this case it may be impractical to de-energize the entire feeder system to work on one transformer.

This disconnect is to be installed either in sight of or must be equipped with a locking means when in the off position.

Where located in a remote location, the disconnecting means shall be lockable, and the location shall be field marked on the transformer.

NEC Language

Transformers, other than Class 2 or Class 3 transformers, shall have a disconnecting means located either in sight of the transformer or in a remote location. Where located in a remote location, the disconnecting means shall be lockable, and the location shall be field marked on the transformer.

Article 480 — Storage Batteries

Article 480 addresses stationary batteries for commercial and industrial grade power supplies, not the small point of use UPS boxes.

Stationary batteries are also used in other applications, such as emergency power systems. Regardless of what the application is, if it uses stationary batteries, then article 480 applies.

Lead acid stationary batteries fall into two general categories: flooded, and valve regulated (VRLA). These differ markedly in such ways as maintainability, total cost of ownership, and scalability. The and NEC does not address these differences, as they are engineering issues and not fire safety or electrical safety issues.

The code does not address such design issues as optimal tier height, distance between tiers, determination of charging voltage, or string configuration. Nor does it address battery testing, monitoring, or maintenance. All of these involve highly specialized areas of knowledge, and are required for optimizing operational efficiency. Standards other than the NEC address these issues.

What the code does and doesn't address the article 480, are issues related to preventing electrocution and the ignition of the gases that all stationary batteries (even sealed ones) emit.

480.2 Definitions

Changed From NEC 2008

480.2. Battery System: Added new definition to correlate with use of the term in Article 480 requirements.

NEC Language

Battery System. Interconnected battery subsystems consisting of one or more storage batteries and battery chargers, and can include inverters, converters, and associated electrical equipment.

Changed From NEC 2008

480.2. Nominal Battery Voltage: This was revised to cover batteries other than lead-acid and alkali type.

NEC Language

Nominal Battery Voltage. The voltage of a battery based on the number and type of cells in the battery.

Informational Note: The most common nominal cell voltages are 2 volts per cell for the lead-acid systems, 1.2 volts per cell for alkali systems, and 4 volts per cell for Li-ion systems. Nominal voltages might vary with different chemistries.

480.5 Disconnecting Means

Changed From NEC 2008

480.5 and Informational Note: Revised voltage level at which a system disconnecting means is required from 30 volts to 50 volts. New informational note referencing 240.21(H) was added.

NEC Language

A disconnecting means shall be provided for all ungrounded conductors derived from a stationary battery system over 50 volts. A disconnecting means shall be readily accessible and located within sight of the battery system.

Informational Note: See 240.21(H) for information on the location of the overcurrent device for battery conductors.

Article 490 — Equipment, Over 600 Volts, Nominal

This article covers the general requirements for equipment operating at more than 600 volts, nominal.

Informational Note No. 1: See NFPA 70E-2009, Standard for Electrical Safety in the Workplace, for electrical safety requirements for employee workplaces.

Informational Note No. 2: For further information on hazard signs and labels, see ANSI Z535.4-1998, Product Signs and Safety Labels.

II. Equipment — Specific Provisions

490.21 Circuit-Interrupting Devices

(A) Circuit Breakers.

(1) Location.

Changed From NEC 2008

490.21(A)(1)(b): This was revised to clarify that the transformer is located in a vault.

NEC Language

(a) Circuit breakers installed indoors shall be mounted either in metal-enclosed units or fire-resistant cell-mounted units, or they shall be permitted to be open-mounted in locations accessible to qualified persons only.

(b) Circuit breakers used to control oil-filled transformers in a vault shall either be located outside the transformer vault or be capable of operation from outside the vault.

(c) Oil circuit breakers shall be arranged or located so that adjacent readily combustible structures or materials are safeguarded in an approved manner.

(2) **Operating Characteristics.** Circuit breakers shall have the following equipment or operating characteristics:

Changed From NEC 2008

490.21(A)(2)(1): This was revised by replacing “approved” with “identified.”

NEC Language

(1) An accessible mechanical or other *identified* means for manual tripping, independent of control power.

490.22 Isolating Means

Changed From NEC 2008

490.22: This was revised to specify that equipment is to be isolated from the ungrounded conductors.

NEC Language

Means shall be provided to completely isolate an item of equipment from all ungrounded conductors. The use of isolating switches shall not be required where there are other ways of de-energizing the equipment for inspection and repairs, such as draw-out-type metal-enclosed switchgear units and removable truck panels.

Isolating switches not interlocked with an approved circuit-interrupting device shall be provided with a sign warning against opening them under load.

A fuseholder and fuse, designed for the purpose, shall be permitted as an isolating switch.

III. Equipment — Metal-Enclosed Power Switchgear and Industrial Control Assemblies

490.33 Guarding of Energized Parts Operating at 600 Volts, Nominal, or Less Within Compartments

Changed From NEC 2008

490.33: This was revised to provide a specific operating voltage.

NEC Language

Energized bare parts mounted on doors shall be guarded where the door must be opened for maintenance of equipment or removal of draw-out equipment.

490.35 Accessibility of Energized Parts

NEC Language

(A) **High-Voltage Equipment.** Doors that would provide unqualified persons access to high-voltage energized parts shall be locked.

Changed From NEC 2008

490.35(B) **Control Equipment:** This was revised to provide a specific operating voltage.

NEC Language

(B) **Control Equipment.** Where operating at 600 volts, nominal, or less, control equipment, relays, motors, and the like shall not be installed in compartments with exposed high-voltage energized parts or high-voltage wiring, unless either of the following conditions is met:

- (1) The access means is interlocked with the high-voltage switch or disconnecting means to prevent the access means from being opened or removed.
- (2) The high-voltage switch or disconnecting means is in the isolating position.

490.40 Visual Inspection Windows

Changed From NEC 2008

490.40: This was revised to clarify that windows are provided for visual inspection.

NEC Language

Windows intended for visual inspection of disconnecting switches or other devices shall be of suitable transparent material.

490.41 Location of Industrial Control Equipment

Changed From NEC 2008

490.41: This was revised to indicate that the requirement applies to industrial control equipment.

NEC Language

Routinely operated industrial control equipment shall meet the requirements of (A) unless infrequently operated, as covered in 490.41(B).

(A) **Control and Instrument Transfer Switch Handles or Push Buttons.** Control and instrument transfer switch handles or push buttons shall be in a readily accessible location at an elevation of not over 2.0 m (6 ft 7 in.).

Exception: Operating handles requiring more than 23 kg (50 lb) of force shall be located no higher than 1.7 m (66 in.) in either the open or closed position.

Changed From NEC 2008

490.41(B) **Infrequently Operated Devices:** This was revised editorially for clarity and added isolating switches as type of equipment covered by requirement.

NEC Language

(B) **Infrequently Operated Devices.** Where operating handles for such devices as draw-out fuses, fused potential or control transformers and their primary disconnects, and bus transfer and isolating switches are only operated infrequently, the handles shall be permitted to be located where they are safely operable and serviceable from a portable platform.

V. Electrode-Type Boilers**490.74 Bonding****Changed From NEC 2008**

490.74: Revised title from “Grounding” to “Bonding” because requirement covers bonding of exposed metal structures and equipment.

NEC Language

All exposed non-current-carrying metal parts of the boiler and associated exposed metal structures or equipment shall be bonded to the pressure vessel or to the neutral conductor to which the vessel is connected in accordance with 250.102, except the ampacity of the bonding jumper shall not be less than the ampacity of the neutral conductor.

Final Exam

1. **Tables 400.5(A)(1) & (A)(2):** Flexible cords and cables used in ambient temperatures below _____ now require ambient temperature adjustment correction factors.
 - a. 84° F
 - b. 86° F
 - c. 89° F
 - d. 90° F

2. True or False: **400.5(B) Ultimate Insulation Temperature.** The NEC does not allow for conductors to be associated together in such a way with respect to the kind of circuit, the wiring method used, or the number of conductors such that the limiting temperature of the conductors is exceeded.
 - a. True
 - b. False

3. **404.1: Installation – Scope** was revised to specify that requirements apply to equipment operating at _____ and below unless otherwise specified.
 - a. 100 volts
 - b. 200 volts
 - c. 400 volts
 - d. 600 volts

4. True or False: **404.2(C) Switches Controlling Lighting Loads:** A grounded conductor is not required at most switch locations.
 - a. True
 - b. False

5. According to **404.4 Damp or Wet Locations**, the NEC formatted into a list the requirements for switches in damp or wet locations. This was revised editorially as three separate requirements by subdividing and adding new title to clearly identify the requirement for field marking. Which statement about the list below is the most accurate?
 - a. Surface-Mounted Switch or Circuit Breaker. A surface-mounted switch or circuit breaker shall be enclosed in a weatherproof enclosure or cabinet that shall comply with 312.2.
 - b. Flush-Mounted Switch or Circuit Breaker. A flush-mounted switch or circuit breaker shall be equipped with a weatherproof cover.
 - c. Switches in Tub or Shower Spaces. Switches shall not be installed within tubs or shower spaces unless installed as part of a listed tub or shower assembly.
 - d. All items on the list are accurate

6. True or False: **404.9(B) Exception No. 1** was revised to specify proximity to ground or exposed grounded metal objects. Where no means exists within the snap-switch enclosure for connecting to the equipment grounding conductor, or where the wiring method does not include or provide an equipment grounding conductor, a snap switch without a connection to an equipment grounding conductor shall be permitted for replacement purposes only.
 - a. True
 - b. False

7. Referring to the previous question on **404.9(B) Exception No. 1**, the NEC further specifies that a snap switch wired under the provisions of this exception and located within _____, of

ground or exposed grounded metal objects shall be provided with a faceplate of nonconducting noncombustible material with nonmetallic attachment screws, unless the switch mounting strap or yoke is nonmetallic or the circuit is protected by a ground-fault circuit interrupter.

- a. 4 ft vertically, or 4 ft horizontally
- b. 5 ft vertically, or 8 ft horizontally
- c. 8 ft vertically, or 5 ft horizontally
- d. None of the above

8. According to **404.9(B) Exception No. 2**, the NEC added new exception covering listed nonmetallic kits or assemblies. Listed kits or listed assemblies shall not be required to be connected to an equipment grounding conductor if which of the following conditions is met:

- a. The device is provided with a nonmetallic faceplate that cannot be installed on any other type of device,
- b. The device does not have mounting means to accept other configurations of faceplates,
- c. The device is equipped with a nonmetallic yoke, and All parts of the device that are accessible after installation of the faceplate are manufactured of nonmetallic materials.
- d. All of the conditions above must be met

9. **404.9(C) Construction:** The NEC revised this to provide correct thickness for faceplates constructed of insulating material. Metal faceplates shall be of ferrous metal not less than _____ in thickness or of nonferrous metal not less than:

- a. 0.030 in. in thickness
- b. 0.040 in. in thickness
- c. 0.050 in. in thickness
- d. None of the above

10. True or False: **404.14(F) Cord-and-Plug-Connected Loads:** Where a snap switch is used to control cord-and-plug-connected equipment on a general-purpose branch circuit, each snap switch controlling receptacle outlets or cord connectors that are supplied by permanently connected cord pendants shall be rated at not less than the rating of the maximum permitted ampere rating or setting of the overcurrent device protecting the receptacles or cord connectors, as provided in 210.21(B).

- a. True
- b. False

11. **406.2 Child Care Facility:** A building or structure, or portion thereof, for educational, supervisory, or personal care services for more than four children ___ years old or less.

- a. 5
- b. 6
- c. 7
- d. 8

12. **406.4(D)(4) Arc-Fault Circuit-Interrupter Protection** states: Where a receptacle outlet is supplied by a branch circuit that requires arc-fault circuit interrupter protection as specified elsewhere in this Code, a replacement receptacle at this outlet shall be one of the following:

- a. A listed outlet branch circuit type arc-fault circuit interrupter receptacle
- b. A receptacle protected by a listed outlet branch circuit type arc-fault circuit interrupter type receptacle
- c. A receptacle protected by a listed combination type arc-fault circuit interrupter type circuit breaker
- d. Any of the above

13. True or False: **406.6**: The NEC was revised to provide a requirement on faceplate position where a faceplate is installed in a box to cover a recessed receptacle. Receptacle faceplates shall now be installed so as to completely cover the opening and seat against the mounting surface, and if mounted inside a box having a recess-mounted receptacle shall effectively close the opening and seat against the mounting surface.

- a. True
- b. False

14. True or False: **406.9 (B) (1)** states that 15- and 20-ampere, 125- and 250-volt receptacles installed in a wet location need not have an enclosure that is weatherproof if the attachment plug cap is inserted.

- a. True
- b. False

15. **409.104(A) General**: Industrial control panel enclosures shall not be used as junction boxes, auxiliary gutters, or raceways for conductors feeding through or tapping off to other switches or overcurrent devices or other equipment, unless the conductors fill less than 40 percent of the cross-sectional area of the wiring space. In addition, the conductors, splices, and taps shall not fill the wiring space at any cross section to more than ___ percent of the cross-sectional area of that space.

- a. 25
- b. 50
- c. 75
- d. 80

16. **According to 410.16(A): Luminaire Types Permitted**, only luminaires of the following types shall be permitted in a closet:

- a. Surface-mounted or recessed incandescent or LED luminaires with completely enclosed light sources
- b. Surface-mounted or recessed fluorescent luminaires
- c. Surface-mounted fluorescent or LED luminaires identified as suitable for installation within the closet storage space
- d. Any of the above

17. **410.24 (A) Independent of the Outlet Box**. Which response is **NOT correct** regarding the following?

Electric-discharge and LED luminaires supported independently of the outlet box shall be connected to the branch circuit through:

- a. Metal raceway
- b. Nonmetallic raceway
- c. Metallic sheathed cable
- d. Type MC cable

18. True or False: **410.24 (B) Access to Boxes** was revised to include LED luminaires. Electric-discharge and LED luminaires surface mounted over concealed outlet, pull, or junction boxes and designed not to be supported solely by the outlet box shall be provided with suitable openings in the back of the luminaire to provide access to the wiring in the box.

- a. True
- b. False

19. According to **410.42 Luminaire(s) with Exposed Conductive Parts**, exposed metal parts shall be connected to an equipment grounding conductor or insulated from the equipment grounding conductor and other conducting surfaces or be inaccessible to unqualified personnel. Lamp tie wires, mounting screws, clips, and decorative bands on glass spaced at least _____ from lamp terminals shall not be required to be grounded.

- a. 1½ in
- b. 2.0 in
- c. 2½ in
- d. 0.5 in

20. **410.68 Feeder and Branch-Circuit Conductors and Ballasts**. Feeder and branch-circuit conductors within _____ of a ballast, LED driver, power supply, or transformer shall have an insulation temperature rating not lower than 90°C (194°F), unless supplying a luminaire marked as suitable for a different insulation temperature.

- a. 1 in
- b. 2 in
- c. 2 ½ in
- d. 3 in

21. **410.74: (A) Marking** was revised to include LED drivers and power supplies. It stipulates that all luminaires shall be marked with:

- a. The maximum lamp wattage or electrical rating
- b. Manufacturer's name
- c. Trademark, or other suitable means of identification
- d. All of the above

22. **410.74: (A) Marking**. A luminaire requiring supply wire rated higher than 60°C (____) shall be marked with the minimum supply wire temperature rating on the luminaire and shipping carton or equivalent.

- a. 120°F
- b. 130°F
- c. 140°F
- d. All of the above

23. True or False: **410.96** was revised to clarify the use of lampholders based on the location where they are installed. Lampholders installed in wet locations shall be listed for use in wet locations. In damp locations shall be listed for damp locations or shall be listed for wet locations.

- a. True
- b. False

24. **410.97**: Lampholders shall be constructed, installed, or equipped with shades or guards so that combustible material is not subjected to temperatures in excess of _____.

- a. 180°F
- b. 184°F
- c. 194°F
- d. 174°F

25. True or False: **410.122 Lampholders** was revised to delete provision for high-heat type cements. It states that Lampholders of the screw shell type shall be of porcelain or other suitable insulating materials.

- a. True

b. False

26. **410.130(G) (1) General - Disconnecting Means** was revised to require installation of disconnecting means when ballasts are replaced in existing luminaires. The provisions are:

- a. In indoor locations other than dwellings and associated accessory structures, fluorescent luminaires that utilize double-ended lamps and contain ballast(s) that can be serviced in place shall have a disconnecting means either internal or external to each luminaire
- b. For existing installed luminaires without disconnecting means, at the time a ballast is replaced, a disconnecting means shall be installed
- c. The line side terminals of the disconnecting means shall be guarded
- d. All of the above

27. **410.136 Luminaire Mounting (A) Exposed Components.** Luminaires that have exposed ballasts, transformers, LED drivers, or power supplies shall be installed such that _____, or power supplies shall not be in contact with combustible material unless listed for such condition.

- a. Ballasts
- b. Transformers
- c. LED drivers
- d. All of the above

28. **410.136 (B): Combustible Low-Density Cellulose Fiberboard.** Where a surface-mounted luminaire containing a ballast, transformer, LED driver, or power supply is to be installed on combustible low-density cellulose fiberboard, it shall be marked for this condition or shall be spaced not less than _____ from the surface of the fiberboard. Where such luminaires are partially or wholly recessed, the provisions of 410.110 through 410.122 shall apply.

- a. 1.0 in
- b. 1½ in
- c. 2.0 in
- d. 2½ in

29. True or False: **410.137(B) Separate Mounting:** Separately mounted ballasts, transformers, LED drivers, or power supplies that are listed for direct connection to a wiring system shall be required to be additionally enclosed.

- a. True
- b. False

30. **422.31(C) Motor-Operated Appliances Rated over 1/8 Horsepower:** For permanently connected motor-operated appliances with motors rated over 1/8 horse power, the branch-circuit switch or circuit breaker shall be permitted to serve as the disconnecting means where the switch or circuit breaker is _____. The disconnecting means shall comply with 430.109 and 430.110.

- a. Installed on
- b. Within sight from the appliance
- c. Installed in the junction box
- d. None of the above

31. **According to 424.39 Clearance from Other Objects and Openings,** heating elements of cables shall be separated at least 200 mm (8 in.) from the edge of outlet boxes and junction boxes that are to be used for mounting surface luminaires. A clearance of not less than _____ shall be provided from recessed luminaires and their trims, ventilating openings, and

other such openings in room surfaces. No heating cable shall be covered by any surface-mounted equipment.

- a. 1 in
- b. 2 in
- c. 2 ½ in
- d. 3 in

32. **424.44(G) Ground-Fault Circuit-Interrupter Protection:** Which item(s) below was/were added by the 2011 NEC? — Ground-fault circuit-interrupter protection for personnel shall be provided for cables installed in:

- a. Electrically heated floors of bathrooms
- b. Kitchens
- c. Hydromassage bathtub locations
- d. All of the above

33. True or False: **426.20(C)(3)** Equipment that has been listed for other forms of installation shall be installed only in the manner for which it has been identified.

- a. True
- b. False

34. True or False: **430.6 (D) Valve Actuator Motor Assemblies.** For valve actuator motor assemblies (VAMs), the rated current shall be the nameplate full-load current, and this current shall be used to determine the maximum rating or setting of the motor branch-circuit short-circuit and ground-fault protective device and the ampacity of the conductors.

- a. True
- b. False

35. **430.22(C) Wye-Start, Delta-Run Motor:** For a wye-start, delta-run connected motor, the ampacity of the branch-circuit conductors on the line side of the controller shall not be less than 125 percent of the motor full-load current as determined by 430.6(A)(1). The ampacity of the conductors between the controller and the motor shall not be less than _____ percent of the motor full-load current rating as determined by 430.6(A)(1).

- a. 60
- b. 70
- c. 72
- d. 75

36. **430.24 Several Motors or a Motor(s) and Other Load(s).** Which statement below is **NOT correct**? Conductors supplying several motors, or a motor(s) and other load(s), shall have an ampacity not less than the sum of each of the following:

- a. 125 percent of the full-load current rating of the highest rated motor, as determined by 430.6(A)
- b. Sum of the full-load current ratings of all the other motors in the group, as determined by 430.6(A)
- c. 100 percent of the noncontinuous non-motor load
- d. 100 percent of the continuous non-motor load

37. **430.42(C) Cord-and-Plug-Connected** states: Where a motor is connected to a branch circuit by means of an attachment plug and a receptacle or a cord connector, and individual overload protection is omitted as provided in 430.42(A), the rating of the attachment plug and receptacle or cord connector shall not exceed _____ at 125 volts or 250 volts.

- a. 10 amperes

- b. 15 amperes
- c. 20 amperes
- d. 25 amperes

38. **430.53 (D)(2). Several Motors or Loads on One Branch Circuit.** (2) No conductor to the motor shall have an ampacity less than one-third that of the branch-circuit conductors, with a minimum in accordance with 430.22, the conductors to the motor overload device being not more than _____ long and being protected from physical damage by being enclosed in an approved raceway or by use of other approved means.

- a. 15 ft
- b. 20 ft
- c. 25 ft
- d. 30 ft

39. True or False: **430.81(B)** states that for a portable motor rated at 1/3 hp or less, the controller shall be permitted to be an attachment plug and receptacle or cord connector.

- a. True
- b. False

40. True or False: **430.109(F) Cord-and-Plug-Connected Motors** was revised to include flanged inlets and cord connectors as means for disconnecting cord-and plug-connected motors. Among its provisions, horsepower-rated attachment plugs, flanged surface inlets, receptacles, or cord connectors shall be required for cord-and-plug-connected appliances in accordance with 422.33, room air conditioners in accordance with 440.63, or portable motors rated 1/3 hp or less.

- a. True
- b. False

41. **430.122 Conductors — Minimum Size and Ampacity. (A) Branch/Feeder Circuit Conductors.** Circuit conductors supplying power conversion equipment included as part of an adjustable-speed drive system shall have an ampacity not less than _____ percent of the rated input current to the power conversion equipment.

- a. 92
- b. 10
- c. 115
- d. 125

42. True or False: **430.225(A) Exception** was revised to apply to motors installed in locations other than a plant. Where a motor is critical to an operation and the motor should operate to failure if necessary to prevent a greater hazard to persons, the sensing device(s) shall be permitted to be connected to a supervised annunciator or alarm instead of interrupting the motor circuit.

- a. True
- b. False

43. **440.55(B) Attachment Plug and Receptacle or Cord Connector Rating:** The rating of the attachment plug and receptacle or cord connector shall not exceed _____ amperes at 125 volts or 15 amperes at 250 volts.

- a. 5
- b. 10
- c. 20
- d. 25

44. **440.63** was revised to include cord connectors as a method for supplying cord- and plug-connected room air conditioners. An attachment plug and receptacle or cord connector shall be permitted to serve as the disconnecting means for a single-phase room air conditioner rated 250 volts or less if the manual controls on the room air conditioner are readily accessible and located within _____ of the floor, or (2) an approved manually operable disconnecting means is installed in a readily accessible location within sight from the room air conditioner.

- a. 9 ft
- b. 8 ft
- c. 7 ft
- d. 6 ft

45. **445.12(A) Constant-Voltage Generators** was revised to include protective relays or other identified overcurrent protective devices as means to protect the generator. This provides that for constant-voltage generators, except ac generator exciters, shall be protected from overload by:

- a. Inherent design
- b. Circuit breakers
- c. Fuses and protective relays
- d. All of the above

46. True or False: **450.14** states that transformers other than listed class 2 or class 3 are not required to have a disconnecting means.

- a. True
- b. False

47. **480.2. Battery System:** The NEC added new definition to correlate with the use of the term in Article 480 requirements. It states that interconnected battery subsystems consisting of one or more storage batteries and battery chargers, can include:

- a. Inverters
- b. Converters
- c. Associated electrical equipment
- d. All of the above

48. **480.2. Nominal Battery Voltage:** This was revised to cover batteries other than lead-acid and alkali type. The voltage of a battery based on the number and type of cells in the battery. The most common nominal cell voltages are:

- a. 2 volts per cell for the lead-acid systems
- b. 1.2 volts per cell for alkali systems
- c. 4 volts per cell for Li-ion systems
- d. All of the above

49. **480.5** revised the voltage level at which a system disconnecting means is required from 30 volts to 50 volts. A new informational note referencing 240.21(H) was added. This states that a disconnecting means shall be provided for all ungrounded conductors derived from a stationary battery system over _____ volts. A disconnecting means shall be readily accessible and located within sight of the battery system.

- a. 50
- b. 40
- c. 30
- d. 20

50. True or False: **490.21(A)(1)(b)** was revised to clarify that the transformer is located in a vault. Specifically, it states that circuit breakers used to control oil-filled transformers in a vault shall either be located outside the transformer vault or be capable of operation from outside the vault.
- a. True
 - b. False

Attachment #2: Instructor Information

Course Instructor:

Joe Crump

Florida Certified Electrical Contractor AC# 2712320

Mr. Crump's resume is attached for review.

Joe H. Crump

1900 Winchester Road North, Saint Petersburg FL 33710
Home (727) 343-0713 Work (727) 224-8200

Experience

L. Crump Electric, Saint Petersburg, FL.

Owner, 1973-Present

Schedule and control up to 75 full time employees. Residential, commercial, and industrial appraiser.

U.S. Army Corp of Engineering, United States Army

Electrical Engineer, 1969-1972

Designed and implemented wiring for military bases. Supervised quality control.

Certification

1966 Journeyman Electrical Certified

1969 Master Electrician — City of Saint Petersburg, FL

1969 United States Civil Service — Skilled Electrician

1970 Department of the Army — Construction Foreman Course

1990 Master Electrician — State of Florida

1991 Southern Building Code Congress — Residential Electrical Inspector

1992 Southern Building Code Congress — Commercial Electrical Inspector

1992 Building Officials and Code Administrators International, Inc. — Certified as a Electrical Inspector

1992 Southern Building Code Congress — Certified as Electrical inspector

1992 Grounding and Bonding Certified

1992 National Certification Program — 1 & 2 Family Housing

1993 National Certification Program — Electrical General

1993 National Certification Program — Commercial

1993 Business Industry Training Institute, Northwest Iowa Community College — 1993 Florida Boards of Building Codes and Standards Certified

1996 NFPA Board Certified into the Electrical Section

1996 Teacher with Pinellas County Vocation Tech School

1996 National Certified as A Board Electrical Contractor

2008 — Florida Certified Electrical Contractor AC# 2712320

2008 — PCCLB License #I-EC 13002856

Education

Attended Florida Beacon College

Bachelor Degree from Rhodes College

MBA from Florida Metropolitan University

Attachment #3: Course Materials and Fees

Course Material:

The course is reviewed online and is available to anyone who purchases it 24/7 as long as there is computer and internet access.

All material necessary to complete the course is included by viewing online. Students are not directed to additional material as a requirement for course completion, only as added information for personal interest.

Course Fee:

The fee for this course is \$44.85

Attachment #4: Schedule of Course Dates and Locations

This course is presented in an online format. The course is available at www.RedVector.com 24 hours a day, 7 days a week to anyone with computer and internet access.

Attachment #6: Online/Correspondence Course Information

Security Procedures Utilized:

All students must register with the web site to gain access to their online course(s). The registration process creates a unique user profile and records their personal information including name, address, phone, email, username, password, licenses held, and license number(s). This information is automatically recorded and saved electronically.

We monitor required student participation in the course by logging and tracking the date and time a student enters a course, tracking activity during the course, and recording the date and time they complete the exam with a required passing score. If our learning management system detects 13-minutes of inactivity, a pop-up appears alerting the student that they must verify their presence or the session times out and the course closes.

In addition, at the completion of an exam, before it is graded, students are asked to confirm an affidavit indicating they personally completed the entire course. They must also confirm their identity before their exam is graded. This confirmation is stored in our database for audit purposes.

Once a student completes and passes the course with a grade of 70% or higher, they are given a certificate of completion and the course completion is recorded in their user profile, along with date and time completed.

End of Course Test:

A copy is attached for review.

Online Course Access:

The Board has been set up with a test account to preview courses on the RedVector.com website. To access the courses, please follow the directions below.

1. Log on to the web site at <http://www.RedVector.com>
2. On the top center of the page click the orange "Sign-In" button.
3. In the gray column labeled "Returning Users" enter your username **VAELEC** and your password **vaelec (both are case-sensitive)**. Click the "LOGIN" button.
4. You should arrive at the User Menu. Click on the second box "My Courses".
5. A list of courses will appear. Click on the title of the course you wish to begin and follow the instructions.

**Exam: 2011 NEC Code Changes - Chapter 4 (4 hour)**

1. Tables 400.5(A)(1) & (A)(2): Flexible cords and cables used in ambient temperatures below _____ now require ambient temperature adjustment correction factors.
 - A. 84°F
 - B. 86°F
 - C. 89°F
 - D. 90° F

2. True or False: 400.5(B) Ultimate Insulation Temperature. The NEC does not allow for conductors to be associated together in such a way with respect to the kind of circuit, the wiring method used, or the number of conductors such that the limiting temperature of the conductors is exceeded.
 - A. TRUE
 - B. FALSE

3. 404.1: Installation – Scope was revised to specify that requirements apply to equipment operating at _____ and below unless otherwise specified.
 - A. 100 volts
 - B. 200 volts
 - C. 400 volts
 - D. 600 volts

4. True or False: 404.2(C) Switches Controlling Lighting Loads: A grounded conductor is not required at most switch locations.
 - A. TRUE
 - B. FALSE

5. According to 404.4 Damp or Wet Locations, the NEC formatted into a list the requirements for switches in damp or wet locations. This was revised editorially as three separate requirements by subdividing and adding new title to clearly identify the requirement for field marking. Which statement about the list below is the most accurate?
 - A. Surface-Mounted Switch or Circuit Breaker. A surface-mounted switch or circuit breaker shall be enclosed in a weatherproof enclosure or cabinet that shall comply with 312.2.
 - B. Flush-Mounted Switch or Circuit Breaker. A flush-mounted switch or circuit breaker shall be equipped with a weatherproof cover.
 - C. Switches in Tub or Shower Spaces. Switches shall not be installed within tubs or shower spaces unless installed as part of a listed tub or shower assembly.
 - D. All items on the list are accurate

6. True or False: 404.9(B) Exception No. 1 was revised to specify proximity to ground or exposed grounded metal objects. Where no means exists within the snap-switch enclosure for connecting

to the equipment grounding conductor, or where the wiring method does not include or provide an equipment grounding conductor, a snap switch without a connection to an equipment grounding conductor shall be permitted for replacement purposes only.

- A. TRUE
- B. FALSE

7. Referring to the previous question on 404.9(B) Exception No. 1, the NEC further specifies that a snap switch wired under the provisions of this exception and located within _____ of ground or exposed grounded metal objects shall be provided with a faceplate of nonconducting noncombustible material with nonmetallic attachment screws, unless the switch mounting strap or yoke is nonmetallic or the circuit is protected by a ground-fault circuit interrupter.
- A. 4 ft vertically, or 4 ft horizontally
 - B. 5 ft vertically, or 8 ft horizontally
 - C. 8 ft vertically, or 5 ft horizontally
 - D. None of the above
8. According to 404.9(B) Exception No. 2, the NEC added new exception covering listed nonmetallic kits or assemblies. Listed kits or listed assemblies shall not be required to be connected to an equipment grounding conductor if which of the following conditions is met:
- A. The device is provided with a nonmetallic faceplate that cannot be installed on any other type of device
 - B. The device does not have mounting means to accept other configurations of faceplates
 - C. The device is equipped with a nonmetallic yoke, and All parts of the device that are accessible after installation of the faceplate are manufactured of nonmetallic materials
 - D. All of the conditions above must be met
9. 404.9(C) Construction: The NEC revised this to provide correct thickness for faceplates constructed of insulating material. Metal faceplates shall be of ferrous metal not less than _____ in thickness or of nonferrous metal not less than:
- A. 0.030 in. in thickness
 - B. 0.040 in. in thickness
 - C. 0.050 in. in thickness
 - D. None of the above
10. True or False: 404.14(F) Cord-and-Plug-Connected Loads: Where a snap switch is used to control cord-and-plug-connected equipment on a general-purpose branch circuit, each snap switch controlling receptacle outlets or cord connectors that are supplied by permanently connected cord pendants shall be rated at not less than the rating of the maximum permitted ampere rating or setting of the overcurrent device protecting the receptacles or cord connectors, as provided in 210.21(B).
- A. TRUE
 - B. FALSE
11. 406.2 Child Care Facility: A building or structure, or portion thereof, for educational, supervisory, or personal care services for more than four children ___ years old or less.
- A. 5

- B. 6
- C. 7
- D. 8

12. 406.4(D)(4) Arc-Fault Circuit-Interrupter Protection states: Where a receptacle outlet is supplied by a branch circuit that requires arc-fault circuit interrupter protection as specified elsewhere in this Code, a replacement receptacle at this outlet shall be one of the following:
- A. A listed outlet branch circuit type arc-fault circuit interrupter receptacle
 - B. A receptacle protected by a listed outlet branch circuit type arc-fault circuit interrupter type receptacle
 - C. A receptacle protected by a listed combination type arc-fault circuit interrupter type circuit breaker
 - D. Any of the above
13. True or False: 406.6: The NEC was revised to provide a requirement on faceplate position where a faceplate is installed in a box to cover a recessed receptacle. Receptacle faceplates shall now be installed so as to completely cover the opening and seat against the mounting surface, and if mounted inside a box having a recess-mounted receptacle shall effectively close the opening and seat against the mounting surface.
- A. TRUE
 - B. FALSE
14. True or False: 406.9 (B) (1) states that 15- and 20-ampere, 125- and 250-volt receptacles installed in a wet location need not have an enclosure that is weatherproof if the attachment plug cap is inserted.
- A. TRUE
 - B. FALSE
15. 409.104(A) General: Industrial control panel enclosures shall not be used as junction boxes, auxiliary gutters, or raceways for conductors feeding through or tapping off to other switches or overcurrent devices or other equipment, unless the conductors fill less than 40 percent of the cross-sectional area of the wiring space. In addition, the conductors, splices, and taps shall not fill the wiring space at any cross section to more than ___ percent of the cross-sectional area of that space.
- A. 25
 - B. 50
 - C. 75
 - D. 80
16. According to 410.16(A): Luminaire Types Permitted, only luminaires of the following types shall be permitted in a closet:
- A. Surface-mounted or recessed incandescent or LED luminaires with completely enclosed light sources
 - B. Surface-mounted or recessed fluorescent luminaires
 - C. Surface-mounted fluorescent or LED luminaires identified as suitable for installation within the closet storage space

D. Any of the above

17. 410.24 (A) Independent of the Outlet Box. Which response is NOT correct regarding the following statement? Electric-discharge and LED luminaires supported independently of the outlet box shall be connected to the branch circuit through:
- A. Metal raceway
 - B. Nonmetallic raceway
 - C. Metallic sheathed cable
 - D. Type MC cable
18. True or False: 410.24 (B) Access to Boxes was revised to include LED luminaires. Electric-discharge and LED luminaires surface mounted over concealed outlet, pull, or junction boxes and designed not to be supported solely by the outlet box shall be provided with suitable openings in the back of the luminaire to provide access to the wiring in the box.
- A. TRUE
 - B. FALSE
19. According to 410.42 Luminaire(s) with Exposed Conductive Parts, exposed metal parts shall be connected to an equipment grounding conductor or insulated from the equipment grounding conductor and other conducting surfaces or be inaccessible to unqualified personnel. Lamp tie wires, mounting screws, clips, and decorative bands on glass spaced at least _____ from lamp terminals shall not be required to be grounded.
- A. 1½ in
 - B. 2 in
 - C. 2½ in
 - D. 0.5 in
20. 410.68 Feeder and Branch-Circuit Conductors and Ballasts. Feeder and branch-circuit conductors within _____ of a ballast, LED driver, power supply, or transformer shall have an insulation temperature rating not lower than 90°C (194° F), unless supplying a luminaire marked as suitable for a different insulation temperature.
- A. 1 in
 - B. 2 in
 - C. 2 1/2 in
 - D. 3 in
21. 410.74: (A) Marking was revised to include LED drivers and power supplies. It stipulates that all luminaires shall be marked with:
- A. The maximum lamp wattage or electrical rating
 - B. Manufacturer's name
 - C. Trademark, or other suitable means of identification
 - D. All of the above
22. 410.74: (A) Marking. A luminaire requiring supply wire rated higher than 60°C (____) shall be

marked with the minimum supply wire temperature rating on the luminaire and shipping carton or equivalent.

- A. 120°F
- B. 130°F
- C. 140°F
- D. None of the above

23. True or False: 410.96 was revised to clarify the use of lampholders based on the location where they are installed. Lampholders installed in wet locations shall be listed for use in wet locations. In damp locations shall be listed for damp locations or shall be listed for wet locations.
- A. TRUE
 - B. FALSE
24. 410.97: Lampholders shall be constructed, installed, or equipped with shades or guards so that combustible material is not subjected to temperatures in excess of _____.
- A. 180°F
 - B. 184°F
 - C. 194°F
 - D. 174°F
25. True or False: 410.122 Lampholders was revised to delete provision for high-heat type cements. It states that Lampholders of the screw shell type shall be of porcelain or other suitable insulating materials.
- A. TRUE
 - B. FALSE
26. 410.130(G) (1) General - Disconnecting Means was revised to require installation of disconnecting means when ballasts are replaced in existing luminaires. The provisions are:
- A. In indoor locations other than dwellings and associated accessory structures, fluorescent luminaires that utilize double-ended lamps and contain ballast(s) that can be serviced in place shall have a disconnecting means either internal or external to each
 - B. For existing installed luminaires without disconnecting means, at the time a ballast is replaced, a disconnecting means shall be installed
 - C. The line side terminals of the disconnecting means shall be guarded
 - D. All of the above
27. 410.136 Luminaire Mounting (A) Exposed Components. Luminaires that have exposed ballasts, transformers, LED drivers, or power supplies shall be installed such that _____, or power supplies shall not be in contact with combustible material unless listed for such condition.
- A. Ballasts
 - B. Transformers
 - C. LED drivers
 - D. All of the above

28. 410.136 (B): Combustible Low-Density Cellulose Fiberboard. Where a surface-mounted luminaire containing a ballast, transformer, LED driver, or power supply is to be installed on combustible low-density cellulose fiberboard, it shall be marked for this condition or shall be spaced not less than _____ from the surface of the fiberboard. Where such luminaires are partially or wholly recessed, the provisions of 410.110 through 410.122 shall apply.
- A. 1 in
 - B. 1½ in
 - C. 2 in
 - D. 2½ in
29. True or False: 410.137(B) Separate Mounting: Separately mounted ballasts, transformers, LED drivers, or power supplies that are listed for direct connection to a wiring system shall be required to be additionally enclosed.
- A. TRUE
 - B. FALSE
30. 422.31(C) Motor-Operated Appliances Rated over 1/8 Horsepower: For permanently connected motor-operated appliances with motors rated over 1/8 horse power, the branch-circuit switch or circuit breaker shall be permitted to serve as the disconnecting means where the switch or circuit breaker is _____. The disconnecting means shall comply with 430.109 and 430.110.
- A. Installed on
 - B. Within sight from the appliance
 - C. Installed in the junction box
 - D. None of the above
31. According to 424.39 Clearance from Other Objects and Openings, heating elements of cables shall be separated at least 200 mm (8 in.) from the edge of outlet boxes and junction boxes that are to be used for mounting surface luminaires. A clearance of not less than _____ shall be provided from recessed luminaires and their trims, ventilating openings, and other such openings in room surfaces. No heating cable shall be covered by any surface-mounted equipment.
- A. 1 in
 - B. 2 in
 - C. 2½ in
 - D. 3 in
32. 424.44(G) Ground-Fault Circuit-Interrupter Protection: Which item(s) below was/were added by the 2011 NEC? - Ground-fault circuit-interrupter protection for personnel shall be provided for cables installed in:
- A. Electrically heated floors of bathrooms
 - B. Kitchens
 - C. Hydromassage bathtub locations
 - D. All of the above
33. True or False: 426.20(C)(3) Equipment that has been listed for other forms of installation shall be installed only in the manner for which it has been identified.

- A. TRUE
- B. FALSE

34. True or False: 430.6 (D) Valve Actuator Motor Assemblies. For valve actuator motor assemblies (VAMs), the rated current shall be the nameplate full-load current, and this current shall be used to determine the maximum rating or setting of the motor branch-circuit short-circuit and ground-fault protective device and the ampacity of the conductors.
- A. TRUE
 - B. FALSE
35. 430.22(C) Wye-Start, Delta-Run Motor: For a wye-start, delta-run connected motor, the ampacity of the branch-circuit conductors on the line side of the controller shall not be less than 125 percent of the motor full-load current as determined by 430.6(A)(1). The ampacity of the conductors between the controller and the motor shall not be less than _____ percent of the motor full-load current rating as determined by 430.6(A)(1).
- A. 60
 - B. 70
 - C. 72
 - D. 75
36. 430.24 Several Motors or a Motor(s) and Other Load(s). Which statement below is NOT correct? Conductors supplying several motors, or a motor(s) and other load(s), shall have an ampacity not less than the sum of each of the following:
- A. 125 percent of the full-load current rating of the highest rated motor, as determined by 430.6(A)
 - B. Sum of the full-load current ratings of all the other motors in the group, as determined by 430.6(A)
 - C. 100 percent of the noncontinuous non-motor load
 - D. 100 percent of the continuous non-motor load
37. 430.42(C) Cord-and-Plug-Connected states: Where a motor is connected to a branch circuit by means of an attachment plug and a receptacle or a cord connector, and individual overload protection is omitted as provided in 430.42(A), the rating of the attachment plug and receptacle or cord connector shall not exceed _____ at 125 volts or 250 volts.
- A. 10 amperes
 - B. 15 amperes
 - C. 20 amperes
 - D. 25 amperes
38. 430.53 (D)(2). Several Motors or Loads on One Branch Circuit. (2) No conductor to the motor shall have an ampacity less than one-third that of the branch-circuit conductors, with a minimum in accordance with 430.22. the conductors to the motor overload device being not more than _____ long and being protected from physical damage by being enclosed in an approved raceway or by use of other approved means.
- A. 15 ft
 - B. 20 ft

- C. 25 ft
- D. 30 ft

39. True or False: 430.81(B) states that for a portable motor rated at 1/3 hp or less, the controller shall be permitted to be an attachment plug and receptacle or cord connector.
- A. TRUE
 - B. FALSE
40. True or False: 430.109(F) Cord-and-Plug-Connected Motors was revised to include flanged inlets and cord connectors as means for disconnecting cord-and plug-connected motors. Among its provisions, horsepower-rated attachment plugs, flanged surface inlets, receptacles, or cord connectors shall be required for cord-and-plug-connected appliances in accordance with 422.33, room air conditioners in accordance with 440.63, or portable motors rated 1/3 hp or less.
- A. TRUE
 - B. FALSE
41. 430.122 Conductors — Minimum Size and Ampacity. (A) Branch/Feeder Circuit Conductors. Circuit conductors supplying power conversion equipment included as part of an adjustable-speed drive system shall have an ampacity not less than _____ percent of the rated input current to the power conversion equipment.
- A. 92
 - B. 10
 - C. 115
 - D. 125
42. True or False: 430.225(A) Exception was revised to apply to motors installed in locations other than a plant. Where a motor is critical to an operation and the motor should operate to failure if necessary to prevent a greater hazard to persons, the sensing device(s) shall be permitted to be connected to a supervised annunciator or alarm instead of interrupting the motor circuit.
- A. TRUE
 - B. FALSE
43. 440.55(B) Attachment Plug and Receptacle or Cord Connector Rating: The rating of the attachment plug and receptacle or cord connector shall not exceed _____ amperes at 125 volts or 15 amperes at 250 volts.
- A. 5
 - B. 10
 - C. 20
 - D. 25
44. 440.63 was revised to include cord connectors as a method for supplying cord- and plug-connected room air conditioners. An attachment plug and receptacle or cord connector shall be permitted to serve as the disconnecting means for a single-phase room air conditioner rated 250 volts or less if the manual controls on the room air conditioner are readily accessible and located within _____ of the floor, or (2) an approved manually operable disconnecting means is

installed in a readily accessible location within sight from the room air conditioner.

- A. 9 ft
- B. 8 ft
- C. 7 ft
- D. 6 ft

45. 445.12(A) Constant-Voltage Generators was revised to include protective relays or other identified overcurrent protective devices as means to protect the generator. This provides that for constant-voltage generators, except ac generator exciters, shall be protected from overload by:
- A. Inherent design
 - B. Circuit breakers
 - C. Fuses and protective relays
 - D. All of the above
46. True or False: 450.14 states that transformers other than listed class 2 or class 3 are not required to have a disconnecting means.
- A. TRUE
 - B. FALSE
47. 480.2. Battery System: The NEC added new definition to correlate with the use of the term in Article 480 requirements. It states that interconnected battery subsystems consisting of one or more storage batteries and battery chargers, can include:
- A. Inverters
 - B. Converters
 - C. Associated electrical equipment
 - D. All of the above
48. 480.2. Nominal Battery Voltage: This was revised to cover batteries other than lead-acid and alkali type. The voltage of a battery based on the number and type of cells in the battery. The most common nominal cell voltages are:
- A. 2 volts per cell for the lead-acid systems
 - B. 1.2 volts per cell for alkali systems
 - C. 4 volts per cell for Li-ion systems
 - D. All of the above
49. 480.5 revised the voltage level at which a system disconnecting means is required from 30 volts to 50 volts. A new informational note referencing 240.21(H) was added. This states that a disconnecting means shall be provided for all ungrounded conductors derived from a stationary battery system over _____ volts. A disconnecting means shall be readily accessible and located within sight of the battery system.
- A. 50
 - B. 40
 - C. 30
 - D. 20

50. True or False: 490.21(A)(1)(b) was revised to clarify that the transformer is located in a vault. Specifically, it states that circuit breakers used to control oil-filled transformers in a vault shall either be located outside the transformer vault or be capable of operation from outside the vault.
- A. TRUE
 - B. FALSE

Attachment #1: Course Syllabus

Course Title:

Series B: 2011 NEC Code Changes - Chapter 5 (RV-10289)

Course Hours:

3 hours

Course Instructor:

Joe Crump

Course Description:

The NFPA® updates to the NEC Code periodically – you need to know the latest updates and the reasons for them.

This **interactive online** course provides you with everything you need to be familiar with the NEC Code – specifically the 2011 version. For all of the major Code changes covered, you'll get:

- A summary addressing each relevant Change.
- Excerpts of actual 2011 National Electrical Code® text with relevant Staff comments and illustrations.
- First-time articles, usability improvements, and revisions that boost electrical safety making the 2011 National Electrical Code® essential.

Course Objectives:

At the conclusion of this course, you will be able to:

- Identify the various significant changes in Chapter 5 of the NEC
- Recognize the reasons for changes to existing Code
- List new articles in the Code
- Describe deletions in some existing requirements

Course Outline:

Introduction

Articles 500.2-501.140

- Article 500 — Hazardous (Classified) Locations, Classes I, II, and III, Divisions 1 and 2
- 500.2 Definitions
- 500.8 Equipment
- Article 501 — Class I Locations
- 501.10 Wiring Methods
- 501.17 Process Sealing
- 501.30 Grounding and Bonding, Class I, Divisions 1 and 2
- 501.140 Flexible Cords, Class I, Divisions 1 and 2

Articles 502.6-504.30

- Article 502 — Class II Locations
- 502.6 Zone Equipment
- 502.10 Wiring Methods
- 502.30 Grounding and Bonding, Class II, Divisions 1 and 2
- 502.100 Transformers and Capacitors
- 502.115 Switches, Circuit Breakers, Motor Controllers, and Fuses

- 502.130 Luminaires
- 502.140 Flexible Cords — Class II, Divisions 1 and 2
- 502.150 Signaling, Alarm, Remote-Control, and Communications Systems; and Meters, Instruments, and Relays
- Article 503 — Class III Locations
- 503.6 Zone Equipment
- 503.10 Wiring Methods
- 503.30 Grounding and Bonding — Class III, Divisions 1 and 2
- 503.140 Flexible Cords — Class III, Divisions 1 and 2
- Article 504 — Intrinsically Safe Systems
- 504.10 Equipment Installation
- 504.30 Separation of Intrinsically Safe Conductors

Articles 505.7-505.26

- Article 505 — Zone 0, 1, and 2 Locations
- 505.7 Special Precaution
- 505.8 Protection Techniques
- 505.9 Equipment
- 505.15 Wiring Methods
- 505.17 Flexible Cords, Class I, Zones 1 and 2
- 505.25 Grounding and Bonding
- 505.26 Process Sealing

Articles 506.2-514.13

- Article 506 — Zone 20, 21, and 22 Locations for Combustible Dusts or Ignitable Fibers/Flyings
- 506.2 Definitions
- 506.8 Protection Techniques
- 506.9 Equipment Requirements
- 506.15 Wiring Methods
- 506.17 Flexible Cords
- 506.25 Grounding and Bonding
- Article 511 — Commercial Garages, Repair, and Storage
- 511.3 Area Classification, General
- Article 514 — Motor Fuel Dispensing Facilities
- 514.3 Classification of Locations
- 514.8 Underground Wiring
- 514.11 Circuit Disconnects
- 514.13 Provisions for Maintenance and Service of Dispensing Equipment

Articles 515.7-518.5

- Article 515 — Bulk Storage Plants
- 515.7 Wiring and Equipment Above Class I Locations
- 515.8 Underground Wiring
- Article 516 — Spray Application, Dipping, and Coating Processes
- 516.4 Wiring and Equipment in Class I Locations
- 516.7 Wiring and Equipment Not Within Class I and II Locations
- Article 517 — Health Care Facilities
- 517.2 Definitions
- 517.13 Grounding of Receptacles and Fixed Electrical Equipment in Patient Care Areas

- 517.16 Receptacles with Insulated Grounding Terminals
- 517.17 Ground-Fault Protection
- 517.18 General Care Areas
- 517.19 Critical Care Areas
- 517.20 Wet Procedure Locations
- 517.26 Application of Other Articles
- 517.30 Essential Electrical Systems for Hospitals
- 517.63 Grounded Power Systems in Anesthetizing Locations
- 517.80 Patient Care Areas
- 517.160 Isolated Power Systems
- Article 518 — Assembly Occupancies
- 518.3 Other Articles
- 518.5 Supply

Articles 520.6-547.10

- Article 520 — Theaters, Audience Areas of Motion Picture and Television Studios, Performance Areas, and Similar Locations
- 520.6 Number of Conductors in Raceway
- 520.10 Portable Equipment Used Outdoors
- 520.27 Stage Switchboard Feeders
- 520.44 Borders, Proscenium Sidelights, Drop Boxes, and Connector Strips
- 520.50 Road Show Connection Panel (A Type of Patch Panel)
- 520.52 Overcurrent Protection for Branch Circuits
- 520.62 Portable Power Distribution Units
- 520.65 Festoons
- Article 525 — Carnivals, Circuses, Fairs, and Similar Events
- 525.5 Overhead Conductor Clearances
- 525.10 Services
- 525.21 Rides, Tents, and Concessions
- 525.22 Portable Distribution or Termination Boxes
- 525.23 Ground-Fault Circuit-Interrupter (GFCI) Protection
- Article 530 — Motion Picture and Television Studios and Similar Locations
- 530.20 Grounding
- 530.21 Plugs and Receptacles
- 530.51 Lamps in Cellulose Nitrate Film Storage Vaults
- Article 540 — Motion Picture Projection Rooms
- 540.11 Location of Associated Electrical Equipment
- Article 545 — Manufactured Buildings
- 545.2 Definitions
- Article 547 — Agricultural Buildings
- 547.5 Wiring Methods
- 547.8 Luminaires
- 547.9 Electrical Supply to Building(s) or Structure(s) from a Distribution Point
- 547.10 Equipotential Planes and Bonding of Equipotential Planes

Articles 550.13-590.6

- Article 550 — Mobile Homes, Manufactured Homes, and Mobile Home Parks
- 550.13 Receptacle Outlets

- 550.15 Wiring Methods and Materials
- 550.25 Arc-Fault Circuit-Interrupter Protection
- Article 551 — Recreational Vehicles and Recreational Vehicle Parks
- 551.2 Definitions
- 551.30 Generator Installations
- 551.33 Alternate Source Restrictions
- 551.46 Means for Connecting to Power Supply
- 551.47 Wiring Methods
- 551.54 Grounding
- 551.55 Interior Equipment Grounding
- 551.60 Factory Tests (Electrical)
- 551.80 Underground Service, Feeder, Branch-Circuit, and Recreational Vehicle Site Feeder-Circuit Conductors
- Article 552 — Park Trailers
- 552.46 Branch Circuits
- 552.59 Outdoor Outlets, Fixtures, Including Luminaires, Air-Cooling Equipment, and So On
- Article 553 — Floating Buildings
- 553.4 Location of Service Equipment
- Article 555 — Marinas and Boatyards
- 555.2 Definitions
- 555.3 Ground-Fault Protection
- 555.12 Load Calculations for Service and Feeder Conductors
- Article 590 — Temporary Installations
- 590.4 General
- 590.6 Ground-Fault Protection for Personnel



2011 NEC® Code Changes – Chapter 5

Developed by National Green Building, Inc.

Course Description

The NFPA updates the NEC Code periodically – you need to know the latest updates and the reasons for them.

This **interactive online** course provides you with everything you need to be familiar with the NEC Code – specifically the 2011 version. For all of the major Code changes covered, you'll get:

- A summary addressing each relevant Change.
- Excerpts of actual 2011 National Electrical Code text with relevant Staff comments and illustrations.
- First-time articles, usability improvements, and revisions that boost electrical safety making the 2008 National Electrical Code essential.

Performance Objectives

At the conclusion of this course, you will be able to:

- Identify the various significant changes in Chapter 5 of the NEC
- Recognize the reasons for changes to existing Code
- List new articles in the Code
- Describe deletions in some existing requirements

References

1. NFPA. *2011 National Electric Code (NEC)*, 2010
2. NFPA. *NEC Plus*, 2010
3. International Association of Electrical Inspectors. *NEC 2011 — Analysis of Changes*, 2010.
4. Mike Holt Enterprises. *Changes to the NEC 2011*, 2010

The designations “*National Electric Code*” and “*NEC*” refer to *NFPA 70, National Electric Code*, which is a registered trademark of the *National Fire Protection Association*.

NOTE:

The National Electric Code is intended for electricians and subcontractors, electrical inspectors, electrical engineers, designers, and other qualified persons who understand electrical currents, theory, safety procedures, and electrical trade practices. The code does not serve as a teaching manual for untrained individuals.

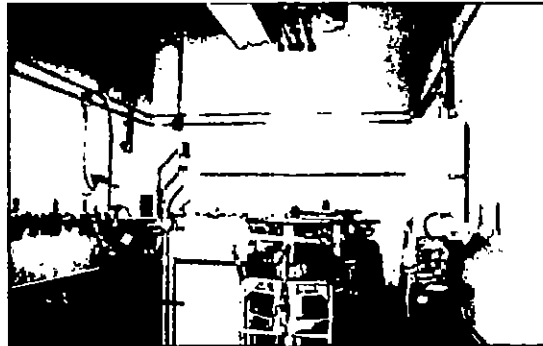

IAEI Magazine

Chapter 5 — Special Occupancies

Chapter 5 is the first of three NEC chapters dealing with *special topics*.

Special Occupancy is a location where the facility or use of the physical facility creates specific conditions that require additional measures to ensure the “practical safeguarding of people and property” consistent with the purpose of the NEC.

ARTICLE 500 — Hazardous (Classified) Locations, Classes I, II, and III, Divisions 1 and 2

The presence of flammable or combustible gases or vapors, combustible dusts, or ignitable fibers and flyings creates the possibility of fire or explosion.

Electric arcs, sparks, and/or heated surfaces can be the source of ignition in such environments.

Article 500 provides the foundation for applying article 501 (Class I Locations), Article 502 (Class II locations), Article 503 (Class III locations), and article 504 (Intrinsically Safe Systems) – all of which immediately follow article 500. This article also provides a foundation for applying articles 510 through 516.

Changed From NEC 2008

500: The NEC revised informational notes to correlate with current titles of standards referenced therein.

NEC Language

Informational Note: Text that is followed by a reference in brackets has been extracted from NFPA 497-2008, Recommended Practice for the Classification of Flammable Liquids, Gases, or Vapors and of Hazardous (Classified) Locations for Electrical Installations in Chemical Process Areas, and NFPA 499-2008, Recommended Practice for the Classification of Combustible Dusts and of Hazardous (Classified) Locations for Electrical Installation in Chemical Process Areas. Only editorial changes were made to the extracted text to make it consistent with this Code.

500.2 Definitions

NEC Language

For purposes of Articles 500 through 504 and Articles 510 through 516, the following definitions apply. *Please note that to preserve context, all of the definitions are displayed. The ones that changed are marked in yellow.*

Associated Nonincendive Field Wiring Apparatus. Apparatus in which the circuits are not necessarily nonincendive themselves but that affect the energy in nonincendive field wiring circuits and are relied upon to maintain nonincendive energy levels. Associated nonincendive field wiring apparatus may be either of the following:

- (1) Electrical apparatus that has an alternative type of protection for use in the appropriate hazardous (classified) location
- (2) Electrical apparatus not so protected that shall not be used in a hazardous (classified) location

Informational Note: Associated nonincendive field wiring apparatus has designated associated nonincendive field wiring apparatus connections for nonincendive field wiring apparatus and may also have connections for other electrical apparatus.

Changed From NEC 2008

500.2 Combustible Dust: The NEC added a new definition (extracted from NFPA 499) for consistency between area classification provisions in NFPA 499 and installation requirements in the NEC.

NEC Language

Combustible Dust. Any finely divided solid material that is 420 microns (0.017 in.) or smaller in diameter (material passing a U.S. No. 40 Standard Sieve) and presents a fire or explosion hazard when dispersed and ignited in air. [499, 2008]

Combustible Gas Detection System. A protection technique utilizing stationary gas detectors in industrial establishments.

Control Drawing. A drawing or other document provided by the manufacturer of the intrinsically safe or associated apparatus, or of the nonincendive field wiring apparatus or associated nonincendive field wiring apparatus, that details the

allowed interconnections between the intrinsically safe and associated apparatus or between the nonincendive field wiring apparatus or associated nonincendive field wiring apparatus.

Dust-Ignitionproof. Equipment enclosed in a manner that excludes dusts and does not permit arcs, sparks, or heat otherwise generated or liberated inside of the enclosure to cause ignition of exterior accumulations or atmospheric suspensions of a specified dust on or in the vicinity of the enclosure.

Informational Note: For further information on dust-ignitionproof enclosures, see Type 9 enclosure in ANSI/NEMA 250-1991, Enclosures for Electrical Equipment, and ANSI/UL 1203-1994, Explosionproof and Dust-Ignitionproof Electrical Equipment for Hazardous (Classified) Locations.

Dusttight. Enclosures constructed so that dust will not enter under specified test conditions.

Informational Note: See ANSI/ISA-12.12.01-2007, Nonincendive Electrical Equipment for Use in Class I and II, Division 2, and Class III, Divisions 1 and 2 Hazardous (Classified) Locations.

Electrical and Electronic Equipment. Materials, fittings, devices, appliances, and the like that are part of, or in connection with, an electrical installation.

Informational Note: Portable or transportable equipment having self-contained power supplies, such as battery-operated equipment, could potentially become an ignition source in hazardous (classified) locations. See ISA-RP12.12.03-2002, Recommended Practice for Portable Electronic Products Suitable for Use in Class I and II, Division 2, Zone 2 and Class III, Division 1 and 2 Hazardous (Classified) Locations.

Changed From NEC 2008

<p>500.2 Explosion Proof Equipment: The NEC revised “apparatus” to “equipment” to be consistent with terms used in Articles 500, 501, 502, and 503</p>

NEC Language

Explosionproof Equipment. Equipment enclosed in a case that is capable of withstanding an explosion of a specified gas or vapor that may occur within it and of preventing the ignition of a specified gas or vapor surrounding the enclosure by sparks, flashes, or explosion of the gas or vapor within, and that operates at such an external temperature that a surrounding flammable atmosphere will not be ignited thereby.

Informational Note: For further information, see ANSI/UL 1203-1994, Explosion-Proof and Dust-Ignition-Proof Electrical Equipment for Use in Hazardous (Classified) Locations.

Hermetically Sealed. Equipment sealed against the entrance of an external atmosphere where the seal is made by fusion, for example, soldering, brazing, welding, or the fusion of glass to metal.

Informational Note: For further information, see ANSI/ISA-12.12.01-2007, Nonincendive Electrical Equipment for Use in Class I and II, Division 2, and Class III, Division 1 and 2 Hazardous (Classified) Locations.

Nonincendive Circuit. A circuit, other than field wiring, in which any arc or thermal effect produced under intended operating conditions of the equipment is not capable, under specified test conditions, of igniting the flammable gas–air, vapor–air, or dust–air mixture.

Informational Note: Conditions are described in ANSI/ISA-12.12.01-2007, Nonincendive Electrical Equipment for Use in Class I and II, Division 2, and Class III, Divisions 1 and 2 Hazardous (Classified) Locations.

Nonincendive Component. A component having contacts for making or breaking an incendive circuit and the contacting mechanism is constructed so that the component is incapable of igniting the specified flammable gas–air or vapor–air mixture. The housing of a nonincendive component is not intended to exclude the flammable atmosphere or contain an explosion.

Informational Note: For further information, see ANSI/ISA-12.12.01-2007, Nonincendive Electrical Equipment for Use in Class I and II, Division 2, and Class III, Divisions 1 and 2 Hazardous (Classified) Locations.

Nonincendive Equipment. Equipment having electrical/electronic circuitry that is incapable, under normal operating conditions, of causing ignition of a specified flammable gas–air, vapor–air, or dust–air mixture due to arcing or thermal means.

Informational Note: For further information, see ANSI/ISA-12.12.01-2007, Nonincendive Electrical Equipment for Use in Class I and II, Division 2, and Class III, Divisions 1 and 2 Hazardous (Classified) Locations.

Nonincendive Field Wiring. Wiring that enters or leaves an equipment enclosure and, under normal operating conditions of the equipment, is not capable, due to arcing or thermal effects, of igniting the flammable gas–air, vapor–air, or dust–air mixture. Normal operation includes opening, shorting, or grounding the field wiring.

Nonincendive Field Wiring Apparatus. Apparatus intended to be connected to nonincendive field wiring.

Informational Note: For further information, see ANSI/ISA-12.12.01-2007, Nonincendive Electrical Equipment for Use in Class I and II, Division 2, and Class III, Divisions 1 and 2 Hazardous (Classified) Locations.

Oil Immersion. Electrical equipment immersed in a protective liquid in such a way that an explosive atmosphere that may be above the liquid or outside the enclosure cannot be ignited.

Informational Note: For further information, see ANSI/UL 698-1995, Industrial Control Equipment for Use in Hazardous (Classified) Locations.

Purged and Pressurized. The process of (1) purging, supplying an enclosure with a protective gas at a sufficient flow and positive pressure to reduce the concentration of any flammable gas or vapor initially present to an acceptable level; and (2) pressurization, supplying an enclosure with a protective gas with or without continuous flow at sufficient pressure to prevent the entrance of a flammable gas or vapor, a combustible dust, or an ignitable fiber.

Informational Note: For further information, see ANSI/ NFPA 496-2008, Purged and Pressurized Enclosures for Electrical Equipment.

Unclassified Locations. Locations determined to be neither Class I, Division 1; Class I, Division 2; Class I, Zone 0; Class I, Zone 1; Class I, Zone 2; Class II, Division 1; Class II, Division 2; Class III, Division 1; Class III, Division 2; Zone 20; Zone 21; Zone 22; or any combination thereof.

500.8 Equipment

Changed From NEC 2008

500.8(E) Threading: This was revised to require entry threads to be either NPT or metric. Requirement for thread engagement and related exception relocated to 500.8(E)(1).

NEC Language

(E) Threading. The supply connection entry thread form shall be NPT or metric. Conduit and fittings shall be made wrenchtight to prevent sparking when fault current flows through the conduit system, and to ensure the explosionproof integrity of the conduit system where applicable. Equipment provided with threaded entries for field wiring connections shall be installed in accordance with 500.8(E)(1) or (E)(2) and with (E)(3).

(1) Equipment Provided with Threaded Entries for NPT Threaded Conduit or Fittings. For equipment provided with threaded entries for NPT threaded conduit or fittings, listed conduit, conduit fittings, or cable fittings shall be used. All NPT threaded conduit and fittings shall be threaded with a National (American) Standard Pipe Taper (NPT) thread.

NPT threaded entries into explosionproof equipment shall be made up with at least five threads fully engaged.

Exception: For listed explosionproof equipment, joints with factory threaded NPT entries shall be made up with at least 4½ threads fully engaged.

Informational Note No. 1: Thread specifications for male NPT threads are located in ANSI/ASME B1.20 1-1983, Pipe Threads, General Purpose (Inch).

Changed From NEC 2008

500.8(E)(1) Informational Note 2: The NEC added a new informational note covering industry standards for female threaded entries.

NEC Language

Informational Note No. 2: Female NPT threaded entries use a modified National Standard Pipe Taper (NPT) thread with thread form per ANSI/ASME B1.20.1-1983, Pipe Threads, General Purpose (Inch). See ANSI/UL 1203, Explosionproof and Dust-Ignition-Proof Electrical Equipment for Use in Hazardous (Classified) Locations.

Changed From NEC 2008

500.8(E)(2) Equipment Provided with Threaded Entries for Metric Threaded Conduit or Fittings: This was revised to require listed conduit or cable fittings

with equipment having metric threaded entries and to provide requirements covering thread engagement for explosionproof equipment having metric threaded entries.

NEC Language

(2) **Equipment Provided with Threaded Entries for Metric Threaded Conduit or Fittings.** For equipment with metric threaded entries, listed conduit fittings or listed cable fittings shall be used. Such entries shall be identified as being metric, or listed adapters to permit connection to conduit or NPT threaded fittings shall be provided with the equipment and shall be used for connection to conduit or NPT threaded fittings.

Changed From NEC 2008

500.8(E)(3) **Unused Openings:** The NEC added a new requirement covering use of listed metal close-up plugs and thread engagement.

NEC Language

(3) **Unused Openings.** All unused openings shall be closed with listed metal close-up plugs. The plug engagement shall comply with 500.8(E)(1) or (E)(2).

Changed From NEC 2008

500.8(F) **Optical Fiber Cables:** This was revised to correlate with the terms used in Article 770.

NEC Language

(F) **Optical Fiber Cables.** Where an optical fiber cable contains conductors that are capable of carrying current (composite optical fiber cable), the optical fiber cable shall be installed in accordance with the requirements of Article 500, 501, 502, or 503, as applicable.

ARTICLE 501 — Class I Locations

A Class I location occurs when sufficient flammable or combustible gases, vapors, or liquids are or may be present to produce an explosive or ignitable mixture. Examples of such locations include fuel storage areas, certain solvent storage areas, grain processing (where hexane is used), plastic extrusion where oil removal is part of the process, refineries, and paint storage areas.

Article 500 contained a general background on hazardous locations and described the differences between Class I, II, and III locations and the differences between Division 1 and Division 2 in each of the three classifications. Article 51 contains the actual class I, Division 1 and Division 2 in each of the three classifications.

Article 501 contains the actual Class I, Division 1 and Division 2 installation requirements, including wiring methods, seals, and specific equipment requirements.

II. Wiring

501.10 Wiring Methods

NEC Language

Wiring methods shall comply with 501.10(A) or (B).

(A) Class I, Division 1.

(1) **General.** In Class I, Division 1 locations, the wiring methods in (a) through (d) shall be permitted.

(a) Threaded rigid metal conduit or threaded steel intermediate metal conduit.

Exception: Type PVC conduit and Type RTRC conduit shall be permitted where encased in a concrete envelope a minimum of 50 mm (2 in.) thick and provided with not less than 600 mm (24 in.) of cover measured from the top of the conduit to grade. The concrete encasement shall be permitted to be omitted where subject to the provisions of 514.8, Exception No. 2, and 515.8(A). Threaded rigid metal conduit or threaded steel intermediate metal conduit shall be used for the last 600 mm (24 in.) of the underground run to emergence or to the point of connection to the aboveground raceway. An equipment grounding conductor shall be included to provide for electrical continuity of the raceway system and for grounding of non-current-carrying metal parts

(b) Type MI cable terminated with fittings listed for the location. Type MI cable shall be installed and supported in a manner to avoid tensile stress at the termination fittings.

Changed From NEC 2008

501.10(A)(1)(c): This was revised to reference installation requirements contained in Article 330.

NEC Language

(c) In industrial establishments with restricted public access, where the conditions of maintenance and supervision ensure that only qualified persons service the installation, Type MC-HL cable listed for use in Class I, Zone 1 or Division 1 locations, with a gas/vaportight continuous corrugated metallic sheath, an overall jacket of suitable polymeric material, and a separate equipment grounding conductor(s) in accordance with 250.122, and terminated with fittings listed for the application.

Type MC-HL cable shall be installed in accordance with the provisions of Article 330, Part II.

Changed From NEC 2008

501.10(A)(1)(d): This was revised to reference installation requirements contained in Article 727.

NEC Language

(d) In industrial establishments with restricted public access, where the conditions of maintenance and supervision ensure that only qualified persons service the installation, Type ITC-HL cable listed for use in Class I, Zone 1 or Division 1 locations, with a gas/vaportight continuous corrugated metallic sheath and an overall jacket of suitable polymeric material, and terminated with fittings listed for the application, and installed in accordance with the provisions of Article 727.

Changed From NEC 2008

501.10(B)(1)(3) & (4): This was revised by adding Type PLTC-ER and ITC-ER and to require cables be terminated with listed fittings.

NEC Language

(3) Type PLTC and Type PLTC-ER cable in accordance with the provisions of Article 725, including installation in cable tray systems. The cable shall be terminated with listed fittings.

(4) Type ITC and Type ITC-ER cable as permitted in 727.4 and terminated with listed fittings.

Changed From NEC 2008

501.10(B)(2)(1): This was revised to require listed fittings.

NEC Language

- (1) Listed flexible metal fittings.
- (2) Flexible metal conduit with listed fittings.
- (3) Liquidtight flexible metal conduit with listed fittings.
- (4) Liquidtight flexible nonmetallic conduit with listed fittings.

(5) Flexible cord listed for extra-hard usage and terminated with listed fittings. A conductor for use as an equipment grounding conductor shall be included in the flexible cord.

Informational Note: See 501.30(B) for grounding requirements where flexible conduit is used.

501.17 Process Sealing

Changed From NEC 2008

501.17: The NEC relocated requirements for process sealing from 501.15(F)(3) and to add requirements covering listed Type MI cable assembly.

NEC Language

This section shall apply to process-connected equipment, which includes, but is not limited to, canned pumps, submersible pumps, flow, pressure, temperature, or analysis measurement instruments. A process seal is a device to prevent the migration of process fluids from the designed containment into the external electrical system. Process connected electrical equipment that incorporates a single process seal, such as a single compression seal, diaphragm, or tube to prevent flammable or combustible fluids from entering a conduit or cable system capable of transmitting fluids, shall be provided with an additional means to mitigate a single process seal failure. The additional means may include, but is not limited to the following:

- (1) A suitable barrier meeting the process temperature and pressure conditions that the barrier will be subjected to upon failure of the single process seal. There shall be a vent or drain between the single process seal and the suitable barrier. Indication of the single process seal failure shall be provided by visible leakage, an audible whistle, or other means of monitoring.
- (2) A listed Type MI cable assembly, rated at not less than 125 percent of the process pressure and not less than 125 percent of the maximum process temperature (in degrees Celsius), installed between the cable or conduit and the single process seal.
- (3) A drain or vent located between the single process seal and a conduit or cable seal. The drain or vent shall be sufficiently sized to prevent overpressuring the conduit or cable seal above 6 in. water column (1493 Pa). Indication of the single process seal failure shall be provided by visible leakage, an audible whistle, or other means of monitoring.

Process-connected electrical equipment that does not rely on a single process seal or is listed and marked "single seal" or "dual seal" shall not be required to be provided with an additional means of sealing.

Informational Note: For construction and testing requirements for process sealing for listed and marked "single seal" or "dual seal" requirements, refer to ANSI/ISA-12.27.01-

2003, Requirements for Process Sealing Between Electrical Systems and Potentially Flammable or Combustible Process Fluids.

501.30 Grounding and Bonding, Class I, Divisions 1 and 2

NEC Language

Wiring and equipment in Class I, Division 1 and 2 locations shall be grounded as specified in Article 250 and in accordance with the requirements of 501.30(A) and (B).

(A) **Bonding.** The locknut-bushing and double-locknut types of contacts shall not be depended on for bonding purposes, but bonding jumpers with proper fittings or other approved means of bonding shall be used. Such means of bonding shall apply to all intervening raceways, fittings, boxes, enclosures, and so forth between Class I locations and the point of grounding for service equipment or point of grounding of a separately derived system.

Exception: The specific bonding means shall be required only to the nearest point where the grounded circuit conductor and the grounding electrode are connected together on the line side of the building or structure disconnecting means as specified in 250.32(B), provided the branch-circuit overcurrent protection is located on the load side of the disconnecting means.

Informational Note: See 250.100 for additional bonding requirements in hazardous (classified) locations.

Changed From NEC 2008

501.30(B) Types of Equipment Grounding Conductors: This was revised to require installation of a wire-type equipment bonding jumper.

Highlight

501.30(B) Grounding and Bonding, Class I, Divisions 1 and 2

502.30(B) Grounding and Bonding, Class II, Divisions 1 and 2

503.30(B) Grounding and Bonding, Class III, Divisions 1 and 2

505.25(B) Class I, Zone 0, 1, and 2 Locations – Grounding and Bonding

506.25(B) Zone 20, 21, and 22 Locations for Combustible Dusts

These sections listed have all been revised to make it clear that an equipment bonding jumper is required when using flexible metal conduit and liquid tight flexible metal conduit.

Currently, the language in the 2008 Code states that flexible metal conduit and liquid tight flexible metal conduit cannot be used as the sole grounding path. This was made clearer by instead stating the requirement of the equipment bonding jumper and rewording the requirement. The sections now contain the text:

"Flexible metal conduit and liquidtight flexible metal conduit shall include an equipment bonding jumper of the wire type in compliance with 250.102."

No changes were made to the application or rule, but rather to clarify of the requirements.

NEC Language

(B) Types of Equipment Grounding Conductors. Flexible metal conduit and liquidtight flexible metal conduit shall include an equipment bonding jumper of the wire type in compliance with 250.102.

Exception: In Class I, Division 2 locations, the bonding jumper shall be permitted to be deleted where all of the following conditions are met:

- (1) Listed liquidtight flexible metal conduit 1.8 m (6 ft) or less in length, with fittings listed for grounding, is used.
- (2) Overcurrent protection in the circuit is limited to 10 amperes or less.
- (3) The load is not a power utilization load.

III. Equipment**501.140 Flexible Cords, Class I, Divisions 1 and 2****NEC Language**

(A) Permitted Uses. Flexible cord shall be permitted:

- (1) For connection between portable lighting equipment or other portable utilization equipment and the fixed portion of their supply circuit.
- (2) For that portion of the circuit where the fixed wiring methods of 501.10(A) cannot provide the necessary degree of movement for fixed and mobile electrical utilization equipment, and the flexible cord is protected by location or by a suitable guard from damage and only in an industrial establishment where conditions of maintenance and engineering supervision ensure that only qualified persons install and service the installation.
- (3) For electric submersible pumps with means for removal without entering the wet-pit. The extension of the flexible cord within a suitable raceway between the wet-pit and the power source shall be permitted.
- (4) For electric mixers intended for travel into and out of open-type mixing tanks or vats.

Changed From NEC 2008

501.140(A)(5): The NEC added a new requirement covering use of cord-connected temporary portable assemblies.
--

NEC Language

(5) For temporary portable assemblies consisting of receptacles, switches, and other devices that are not considered portable utilization equipment but are individually listed for the location.

(B) Installation. Where flexible cords are used, the cords shall comply with all of the following:

- (1) Be of a type listed for extra-hard usage

- (2) Contain, in addition to the conductors of the circuit, an equipment grounding conductor complying with 400.23
- (3) Be supported by clamps or by other suitable means in such a manner that there is no tension on the terminal connections

Changed From NEC 2008

501.140(B)(4): This was revised to require listed cord connectors, or use of a seal, where cords terminate in explosionproof enclosures.

NEC Language

- (4) In Division 1 locations or in Division 2 locations where the boxes, fittings, or enclosures are required to be explosionproof, the cord shall be terminated with a cord connector or attachment plug listed for the location or a cord connector installed with a seal listed for the location. In Division 2 locations where explosionproof equipment is not required, the cord shall be terminated with a listed cord connector or listed attachment plug.

Changed From NEC 2008

501.140(B)(5) **Be of continuous length**: The NEC revised requirement to cover cords used to supply temporary power assemblies and for equipment supplied from the temporary power assembly.

NEC Language

- (5) **Be of continuous length**. Where 501.140(A)(5) is applied, cords shall be of continuous length from the power source to the temporary portable assembly and from the temporary portable assembly to the utilization equipment.

Informational Note: See 501.20 for flexible cords exposed to liquids having a deleterious effect on the conductor insulation.

ARTICLE 502 — Class II Locations

A Class II location is an area with the presence of combustible dust.

Examples of such locations include flour mills, grain silos, wood pulp storage areas, and munitions plants.

Article 502 follows a logical arrangement similar to that of article 501. Article 502 provides guidance in selecting equipment and wiring methods for Class II locations, including distinctions between Class II Division 1 and Class II Division 2 requirements.

I. General

502.6 Zone Equipment

Changed From NEC 2008

502.6: The NEC added a new permission to use Zone 20 equipment in a Class II, Division 1 or 2 locations.

NEC Language

Equipment listed and marked in accordance with 506.9(C)(2) for Zone 20 locations shall be permitted in Class II, Division 1 locations for the same dust atmosphere; and with a suitable temperature class.

Equipment listed and marked in accordance with 506.9(C)(2) for Zone 20, 21, or 22 locations shall be permitted in Class II, Division 2 locations for the same dust atmosphere and with a suitable temperature class.

II. Wiring**502.10 Wiring Methods****NEC Language**

Wiring methods shall comply with 502.10(A) or (B).

(A) Class II, Division 1.

(1) **General.** In Class II, Division 1 locations, the wiring methods in (1) through (4) shall be permitted:

- (1) Threaded rigid metal conduit, or threaded steel intermediate metal conduit.
- (2) Type MI cable with termination fittings listed for the location. Type MI cable shall be installed and supported in a manner to avoid tensile stress at the termination fittings.
- (3) In industrial establishments with limited public access, where the conditions of maintenance and supervision ensure that only qualified persons service the installation, Type MC-HL cable, listed for use in Class II, Division 1 locations, with a gas/vaportight continuous corrugated metallic sheath, an overall jacket of suitable polymeric material, a separate equipment grounding conductor(s) in accordance with 250.122, and provided with termination fittings listed for the application, shall be permitted.
- (4) Fittings and boxes shall be provided with threaded bosses for connection to conduit or cable terminations and shall be dusttight. Fittings and boxes in which taps, joints, or terminal connections are made, or that are used in Group E locations, shall be identified for Class II locations.

(2) **Flexible Connections.** Where necessary to employ flexible connections, one or more of the following shall also be permitted:

- (1) Dusttight flexible connectors
- (2) Liquidtight flexible metal conduit with listed fittings
- (3) Liquidtight flexible nonmetallic conduit with listed fittings
- (4) Interlocked armor Type MC cable having an overall jacket of suitable polymeric material and provided with termination fittings listed for Class II, Division 1 locations.

(5) Flexible cord listed for extra-hard usage and terminated with listed dusttight fittings. Where flexible cords are used, they shall comply with 502.140.

Informational Note: See 502.30(B) for grounding requirements where flexible conduit is used.

(B) Class II, Division 2.

(1) **General.** In Class II, Division 2 locations, the following wiring methods shall be permitted:

- (1) All wiring methods permitted in 502.10(A).
- (2) Rigid metal conduit, intermediate metal conduit, electrical metallic tubing, dusttight wireways.
- (3) Type MC or MI cable with listed termination fittings.
- (4) Type PLTC and Type PLTC-ER cable in accordance with the provisions of Article 725, including installation in cable tray systems. The cable shall be terminated with listed fittings.
- (5) Type ITC and Type ITC-ER cable as permitted in 727.4 and terminated with listed fittings.
- (6) Type MC, MI, or TC cable installed in ladder, ventilated trough, or ventilated channel cable trays in a single layer, with a space not less than the larger cable diameter between the two adjacent cables, shall be the wiring method employed.

Exception to (6): Type MC cable listed for use in Class II, Division 1 locations shall be permitted to be installed without the spacings required by (6).

Changed From NEC 2008

502.10(B)(1)(7): The NEC added a new requirement permitting Reinforced Thermal Resin Conduit (RTRC-XW) and Polyvinyl Chloride Conduit (PVC) in industrial applications under specified conditions.

NEC Language

(7) In industrial establishments with restricted public access where the conditions of maintenance and supervision ensure that only qualified persons service the installation and where metallic conduit does not provide sufficient corrosion resistance, reinforced thermosetting resin conduit (RTRC) factory elbows, and associated fittings, all marked with suffix -XW, and Schedule 80 PVC conduit, factory elbows and associated fittings shall be permitted.

(2) **Flexible Connections.** Where provision must be made for flexibility, 502.10(A)(2) shall apply.

(3) **Nonincendive Field Wiring.** Nonincendive field wiring shall be permitted using any of the wiring methods permitted for unclassified locations. Nonincendive field wiring systems shall be installed in accordance with the control drawing(s). Simple apparatus, not shown on the control drawing, shall be

permitted in a nonincendive field wiring circuit, provided the simple apparatus does not interconnect the nonincendive field wiring circuit to any other circuit.

Informational Note: Simple apparatus is defined in 504.2.

Separate nonincendive field wiring circuits shall be installed in accordance with one of the following:

- (1) In separate cables
- (2) In multiconductor cables where the conductors of each circuit are within a grounded metal shield

Changed From NEC 2008

502.10(B)(3)(3): This was revised to permit installation of nonincendive field wiring in raceways where conductor insulation thickness is not less than 0.01 in.

NEC Language

- (3) In multiconductor cables or in raceways where the conductors of each circuit have insulation with a minimum thickness of 0.25 mm (0.01 in.)
- (4) **Boxes and Fittings.** All boxes and fittings shall be dust tight.

Boxes and fittings in a Class II, Division 2 location need only be dusttight. Whereas, in Division 1 locations, boxes containing taps, joints, or terminal connections in addition to being dusttight, must be provided with threaded hubs, as shown in Exhibit 502.1, and must be identified for use in Class II locations. Threaded hubs also provide adequate bonding in Division 2 locations. Exhibit 502.1 also shows a dust tight cover, which is necessary for Class II locations.

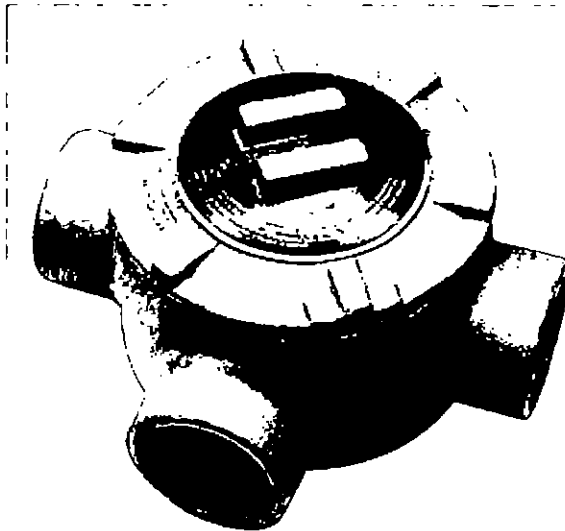

NEC 2011

Exhibit 502.1 Junction box with threaded hubs, suitable for use in Class II, Group E hazardous atmospheres. (Courtesy of Appleton Electric Co., EGS Electrical Group)

Changed From NEC 2008

502.10(B)(4): This was revised to correlate with the wiring methods permitted by Article 725. The NEC added a Type PLTC-ER and ITC-ER and to require cables be terminated with listed fittings.

502.30 Grounding and Bonding, Class II, Divisions 1 and 2**NEC Language**

Wiring and equipment in Class II, Division 1 and 2 locations shall be grounded as specified in Article 250 and in accordance with the requirements of 502.30(A) and (B).

(A) **Bonding.** The locknut-bushing and double-locknut types of contact shall not be depended on for bonding purposes, but bonding jumpers with proper fittings or other approved means of bonding shall be used. Such means of bonding shall apply to all intervening raceways, fittings, boxes, enclosures, and so forth, between Class II locations and the point of grounding for service equipment or point of grounding of a separately derived system.

Exception: The specific bonding means shall only be required to the nearest point where the grounded circuit conductor and the grounding electrode conductor are connected together on the line side of the building or structure disconnecting means as specified in 250.32(B) if the branch-circuit overcurrent protection is located on the load side of the disconnecting means.

Informational Note: See 250.100 for additional bonding requirements in hazardous (classified) locations.

Changed From NEC 2008

502.30(B) **Types of Equipment Grounding Conductors:** This was revised to require installation of a wire-type equipment bonding jumper.

NEC Language

(B) **Types of Equipment Grounding Conductors.** Liquidtight flexible metal conduit shall include an equipment bonding jumper of the wire type in compliance with 250.102.

Exception: In Class II, Division 2 locations, the bonding jumper shall be permitted to be deleted where all of the following conditions are met:

- (1) Listed liquidtight flexible metal conduit 1.8 m (6 ft) or less in length, with fittings listed for grounding, is used.
- (2) Overcurrent protection in the circuit is limited to 10 amperes or less.
- (3) The load is not a power utilization load.

III. Equipment

502.100 Transformers and Capacitors

NEC Language

(A) **Class II, Division 1.** In Class II, Division 1 locations, transformers and capacitors shall comply with 502.100(A)(1) through (A)(3).

(1) **Containing Liquid That Will Burn.** Transformers and capacitors containing a liquid that will burn shall be installed only in vaults complying with 450.41 through 450.48, and, in addition, (1), (2), and (3) shall apply.

(1) Doors or other openings communicating with the Division 1 location shall have self-closing fire doors on both sides of the wall, and the doors shall be carefully fitted and provided with suitable seals (such as weather stripping) to minimize the entrance of dust into the vault.

(2) Vent openings and ducts shall communicate only with the outside air.

(3) Suitable pressure-relief openings communicating with the outside air shall be provided.

(2) **Not Containing Liquid That Will Burn.** Transformers and capacitors that do not contain a liquid that will burn shall be installed in vaults complying with 450.41 through 450.48 or be identified as a complete assembly, including terminal connections.

Changed From NEC 2008

502.100(A)(3) **Group E:** This was revised to prohibit installation of transformers and capacitors in Group E locations.

NEC Language

(3) **Group E.** No transformer or capacitor shall be installed in a Class II, Division 1, Group E location.

502.115 Switches, Circuit Breakers, Motor Controllers, and Fuses

Changed From NEC 2008

502.115(A) **Class II, Division 1:** This was revised to require enclosures identified for the location for all Class II, Division 1, Group E, F, & G applications.

NEC Language

(A) **Class II, Division 1.** In Class II, Division 1 locations, switches, circuit breakers, motor controllers, fuses, push buttons, relays, and similar devices shall be provided with enclosures identified for the location.

Changed From NEC 2008

502.115(B) **Class II, Division 2:** This was revised to require dusttight enclosures or enclosures identified for Class II, Division 2 applications.

NEC Language

(B) **Class II, Division 2.** In Class II, Division 2 locations, enclosures for fuses, switches, circuit breakers, and motor controllers, including push buttons, relays, and similar devices, shall be dusttight or otherwise identified for the location.

502.130 Luminaires**Changed From NEC 2008**

Pendant luminaires in Class II, Division 1 classified areas are permitted to employ flexible cord listed for hard usage as a wiring method when terminated with a listed chord connector that maintains the dust-tight ignition proof protection.

NEC Language

(A) **Class II, Division 1.** In Class II, Division 1 locations, luminaires for fixed and portable lighting shall comply with 502.130(A)(1) through (A)(4).

- (1) **Luminaires.** Each luminaire shall be identified for the location and shall be clearly marked to indicate the maximum wattage of the lamp for which it is designed.
- (2) **Physical Damage.** Each luminaire shall be protected against physical damage by a suitable guard or by location.
- (3) **Pendant Luminaires.** Pendant luminaires shall be suspended by threaded rigid metal conduit stems, by threaded steel intermediate metal conduit stems, by chains with approved fittings, or by other approved means. For rigid stems longer than 300 mm (12 in.), permanent and effective bracing against lateral displacement shall be provided at a level not more than 300 mm (12 in.) above the lower end of the stem, or flexibility in the form of a fitting or a flexible connector listed for the location shall be provided not more than 300 mm (12 in.) from the point of attachment to the supporting box or fitting. Threaded joints shall be provided with set screws or other effective means to prevent loosening. Where wiring between an outlet box or fitting and a pendant luminaire is not enclosed in conduit, flexible cord listed for hard usage shall be permitted to be used in accordance with 502.10(A)(2)(5). Flexible cord shall not serve as the supporting means for a luminaire.
- (4) **Supports.** Boxes, box assemblies, or fittings used for the support of luminaires shall be identified for Class II locations.

(B) **Class II, Division 2.** In Class II, Division 2 locations, luminaires shall comply with 502.130(B)(1) through (B)(5).

- (1) **Portable Lighting Equipment.** Portable lighting equipment shall be identified for the location. They shall be clearly marked to indicate the maximum wattage of lamps for which they are designed.

Changed From NEC 2008

502.130(B)(2) **Fixed Lighting**: This was revised to require luminaires with dusttight enclosures or enclosures identified for Class II, Division 2 applications.

NEC Language

(2) **Fixed Lighting**. Luminaires for fixed lighting shall be provided with enclosures that are dusttight or otherwise identified for the location. Each luminaire shall be clearly marked to indicate the maximum wattage of the lamp that shall be permitted without exceeding an exposed surface temperature in accordance with 500.8(D)(2) under normal conditions of use.

502.140 Flexible Cords — Class II, Divisions 1 and 2**Changed From NEC 2008**

502.140(B)(2): This was deleted as the requirements are already covered in 110.14.

502.140(B)(4): The NEC added a new requirement requiring use of listed cord connector.

502.140(B)(4): This was revised to specify requirements covering use of cord connectors in Class II, Divisions 1 & 2 locations.

Flexible cords used in Class II locations shall comply with all of the following:

(1) Be of a type listed for extra-hard usage

Exception: Flexible cord listed for hard usage as permitted by 502.130(A)(3) and (B)(4).

(2) Contain, in addition to the conductors of the circuit, an equipment grounding conductor complying with 400.23

(3) Be supported by clamps or by other suitable means in such a manner that there will be no tension on the terminal connections

(4) In Division 1 locations, the cord shall be terminated with a cord connector listed for the location or a listed cord connector installed with a seal listed for the location. In Division 2 locations, the cord shall be terminated with a listed dusttight cord connector.

502.150 Signaling, Alarm, Remote-Control, and Communications Systems; and Meters, Instruments, and Relays**NEC Language**

Informational Note: See Article 800 for rules governing the installation of communications circuits.

(A) **Class II, Division 1**. In Class II, Division 1 locations, signaling, alarm, remote-control, and communications systems; and meters, instruments, and relays shall comply with 502.150(A)(1) through (A)(3).

(1) **Contacts.** Switches, circuit breakers, relays, contactors, fuses and current-breaking contacts for bells, horns, howlers, sirens, and other devices in which sparks or arcs may be produced shall be provided with enclosures identified for the location. Exception: Where current-breaking contacts are immersed in oil or where the interruption of current occurs within a chamber sealed against the entrance of dust, enclosures shall be permitted to be of the general-purpose type.

(2) **Resistors and Similar Equipment.** Resistors, transformers, choke coils, rectifiers, thermionic tubes, and other heat-generating equipment shall be provided with enclosures identified for the location.

Exception: Where resistors or similar equipment are immersed in oil or enclosed in a chamber sealed against the entrance of dust, enclosures shall be permitted to be of the general-purpose type.

(3) **Rotating Machinery.** Motors, generators, and other rotating electrical machinery shall comply with 502.125(A).

(B) Class II, Division 2. In Class II, Division 2 locations, signaling, alarm, remote-control, and communications systems; and meters, instruments, and relays shall comply with 502.150(B)(1) through (B)(4).

Changed From NEC 2008

502.150(B)(1) **Contacts:** This was revised to allow enclosures that are "otherwise" identified for the location.

NEC Language

(1) **Contacts.** Contacts shall comply with 502.150(A)(1) or shall be installed in enclosures that are dusttight or otherwise identified for the location.

Exception: In nonincendive circuits, enclosures shall be permitted to be of the general-purpose type.

ARTICLE 503 — Class III Locations

A Class III location has the presence of easily ignitable fibers and flyings.

Examples of such locations include sawmills, textile mills, and fiber processing plants.

In many cases, the distinction between Class II and class III locations may be simply the size of the particulate.

A new definition added to Article 502 defines dust based on the size of the particulate, so the same material (such as sawdust) may be subject to Article 503 if the predominant material is "larger" than the definition of dust discovered by Article 502.

I. General

503.6 Zone Equipment

Changed From NEC 2008

503.6: The NEC added a new permission to use Zone 20 equipment in Class III, Division 1 or 2 locations.

NEC Language

Equipment listed and marked in accordance with 506.9(C)(2) for Zone 20 locations and with a temperature class of not greater than T120°C (for equipment that may be overloaded) or not greater than T165°C (for equipment not subject to overloading) shall be permitted in Class III, Division 1 locations.

Equipment listed and marked in accordance with 506.9(C)(2) for Zone 20, 21, or 22 locations and with a temperature class of not greater than T120°C (for equipment that may be overloaded) or not greater than T165°C (for equipment not subject to overloading) shall be permitted in Class III, Division 2 locations.

II. Wiring

503.10 Wiring Methods

NEC Language

Wiring methods shall comply with 503.10(A) or (B).

(A) Class III, Division 1.

Changed From NEC 2008

503.10(A)(1) **General**: This was revised to permit additional wiring methods in a Class III, Division 1 location, and for consistency with the same requirement in Articles 501 and 502.

NEC Language

(1) **General**. In Class III, Division 1 locations, the wiring method shall be in accordance with (1) through (4):

- (1) Rigid metal conduit, Type PVC conduit, Type RTRC conduit, intermediate metal conduit, electrical metallic tubing, dusttight wireways, or Type MC or MI cable with listed termination fittings.
- (2) Type PLTC and Type PLTC-ER cable in accordance with the provisions of Article 725 including installation in cable tray systems. The cable shall be terminated with listed fittings.
- (3) Type ITC and Type ITC-ER cable as permitted in 727.4 and terminated with listed fittings.
- (4) Type MC, MI, or TC cable installed in ladder, ventilated trough, or ventilated channel cable trays in a single layer, with a space not less than

the larger cable diameter between the two adjacent cables, shall be the wiring method employed.

Exception to (4): Type MC cable listed for use in Class II, Division 1 locations shall be permitted to be installed without the spacings required by 503.10(A)(1)(4).

- (2) **Boxes and Fittings.** All boxes and fittings shall be dusttight.
- (3) **Flexible Connections.** Where necessary to employ flexible connections, one or more of the following shall be permitted:
- (1) Dusttight flexible connectors
 - (2) Liquidtight flexible metal conduit with listed fittings
 - (3) Liquidtight flexible nonmetallic conduit with listed fittings

Changed From NEC 2008

503.10(A)(3)(4): The NEC added a new requirement covering use of interlocking armor type MC Cable with overall jacket of polymeric material.

NEC Language

- (4) Interlocked armor Type MC cable having an overall jacket of suitable polymeric material and installed with listed dusttight termination fittings

503.30 Grounding and Bonding — Class III, Divisions 1 and 2

NEC Language

Wiring and equipment in Class III, Division 1 and 2 locations shall be grounded as specified in Article 250 and with the following additional requirements in 503.30(A) and (B).

(A) **Bonding.** The locknut-bushing and double-locknut types of contacts shall not be depended on for bonding purposes, but bonding jumpers with proper fittings or other approved means of bonding shall be used. Such means of bonding shall apply to all intervening raceways, fittings, boxes, enclosures, and so forth, between Class III locations and the point of grounding for service equipment or point of grounding of a separately derived system.

Exception: The specific bonding means shall only be required to the nearest point where the grounded circuit conductor and the grounding electrode conductor are connected together on the line side of the building or structure disconnecting means as specified in 250.32(B) if the branch-circuit overcurrent protection is located on the load side of the disconnecting means.

Changed From NEC 2008

503.30(B) **Types of Equipment Grounding Conductors:** This was revised to require installation of a wire-type equipment bonding jumper.

NEC Language

(B) Types of Equipment Grounding Conductors. Liquidtight flexible metal conduit shall include an equipment bonding jumper of the wire type in compliance with 250.102.

Informational Note: See 250.100 for additional bonding requirements in hazardous (classified) locations.

Exception: In Class III, Division 1 and 2 locations, the bonding jumper shall be permitted to be deleted where all of the following conditions are met:

- (1) Listed liquidtight flexible metal 1.8 m (6 ft) or less in length, with fittings listed for grounding, is used.
- (2) Overcurrent protection in the circuit is limited to 10 amperes or less.
- (3) The load is not a power utilization load.

III. Equipment**503.140 Flexible Cords — Class III, Divisions 1 and 2****NEC Language**

Flexible cords shall comply with the following:

- (1) Be of a type listed for extra-hard usage
- (2) Contain, in addition to the conductors of the circuit, an equipment grounding conductor complying with 400.23
- (3) Be supported by clamps or other suitable means in such a manner that there will be no tension on the terminal connections

Changed From NEC 2008

503.140(4): This was revised to require the use of listed dust tight cord connector.

NEC Language

- (4) Be terminated with a *listed dust tight* cord connector.

ARTICLE 504 — Intrinsically Safe Systems

This article covers the installation of intrinsically safe (I.S.) apparatus, wiring, and systems for Class I, II, and III locations.

Informational Note: For further information, see ANSI/ISA-RP 12.06.01-2003, Recommended Practice for Wiring Methods for Hazardous (Classified) Locations Instrumentation — Part 1: Intrinsic Safety.

504.10 Equipment Installation**NEC Language**

(A) Control Drawing. Intrinsically safe apparatus, associated apparatus, and other equipment shall be installed in accordance with the control drawing(s).

Exception: A simple apparatus that does not interconnect intrinsically safe circuits.

Informational Note No. 1: The control drawing identification is marked on the apparatus.

Informational Note No. 2: Associated apparatus with a marked U_m of less than 250 V may require additional overvoltage protection at the inputs to limit any possible fault voltages to less than the U_m marked on the product.

(B) **Location.** Intrinsically safe apparatus shall be permitted to be installed in any hazardous (classified) location for which it has been identified. General-purpose enclosures shall be permitted for intrinsically safe apparatus.

Associated apparatus shall be permitted to be installed in any hazardous (classified) location for which it has been identified or, if protected by other means, permitted by Articles 501 through 503 and Article 505.

Simple apparatus shall be permitted to be installed in any hazardous (classified) location in which the maximum surface temperature of the simple apparatus does not exceed the ignition temperature of the flammable gases or vapors, flammable liquids, combustible dusts, or ignitable fibers/flyings present.

For simple apparatus, the maximum surface temperature can be determined from the values of the output power from the associated apparatus or apparatus to which it is connected to obtain the temperature class. The temperature class can be determined by:

(1) Reference to Table 504.10(B)

(2) Calculation using the following equation:

$$T = P_o R_{th} + T_{amb}$$

where:

T = surface temperature

P_o = output power marked on the associated apparatus or intrinsically safe apparatus

R_{th} = thermal resistance of the simple apparatus

T_{amb} = ambient temperature (normally 40°C) and reference Table 500.8(C)

In addition, components with a surface area smaller than 10 cm² (excluding lead wires) may be classified as T5 if their surface temperature does not exceed 150°C.

Changed From NEC 2008

Table 504.10(B): This was revised to relocate 40°C ambient temperature information to the existing table note.

Table 504.10(B) Assessment for T4 Classification According to Component Size and Temperature	
Total Surface Area Excluding Lead Wires	Requirement for T4 Classification
<20 mm ²	Surface temperature ≤275°C
≥20 mm ² ≤10 cm ²	Surface temperature ≤200°C
≥20 mm ²	Power not exceeding 1.3 W*

*Based on 40°C ambient temperature. Reduce to 1.2 W with an ambient of 60°C or 1.0 W with 80°C ambient temperature.

NEC 2011

Informational Note: The following apparatus are examples of simple apparatus:

- (1) Passive components, for example, switches, junction boxes, resistance temperature devices, and simple semiconductor devices such as LEDs
- (2) Sources of generated energy, for example, thermocouples and photocells, which do not generate more than 1.5 V, 100 mA, and 25 mW

504.30 Separation of Intrinsically Safe Conductors

NEC Language

(A) From Nonintrinsically Safe Circuit Conductors.

(1) In Raceways, Cable Trays, and Cables. Conductors of intrinsically safe circuits shall not be placed in any raceway, cable tray, or cable with conductors of any nonintrinsically safe circuit.

Exception No. 1: Where conductors of intrinsically safe circuits are separated from conductors of nonintrinsically safe circuits by a distance of at least 50 mm (2 in.) and secured, or by a grounded metal partition or an approved insulating partition.

Informational Note: No. 20 gauge sheet metal partitions 0.91 mm (0.0359 in.) or thicker are generally considered acceptable.

Exception No. 2: Where either (1) all of the intrinsically safe circuit conductors or (2) all of the nonintrinsically safe circuit conductors are in grounded metal-sheathed or metal-clad cables where the sheathing or cladding is capable of carrying fault current to ground.

Informational Note: Cables meeting the requirements of Articles 330 and 332 are typical of those considered acceptable.

Exception No. 3: Intrinsically safe circuits in a Division 2 or Zone 2 location shall be permitted to be installed in a raceway, cable tray, or cable along with nonincendive field wiring circuits when installed in accordance with 504.30(B).

Exception No. 4: Intrinsically safe circuits passing through a Division 2 or Zone 2 location to supply apparatus that is located in a Division 1, Zone 0 or Zone 1 location shall be permitted to be installed in a raceway, cable tray, or cable along with nonincendive field wiring circuits when installed in accordance with 504.30(B).

Informational Note: Nonincendive field wiring circuits are described in 501.10(B)(3), 502.10(B)(3), 503.10(B)(3), 505.15(C)(1)(g), and 506.15(C)(7).

Changed From NEC 2008

504.30(A)(2) **Within Enclosures**: This was revised to include provision for securing conductors as part of the general requirement that references the methods of separation in (1) through (4).

NEC Language

(2) **Within Enclosures**. Conductors of intrinsically safe circuits shall be secured so that any conductor that might come loose from a terminal is unlikely to come into contact with another terminal. The conductors shall be separated from conductors of nonintrinsically safe circuits by one of the methods in (1) through (4).

(1) Separation by at least 50 mm (2 in.) from conductors of any nonintrinsically safe circuits.

(2) Separation from conductors of nonintrinsically safe circuits by use of a grounded metal partition 0.91 mm (0.0359 in.) or thicker.

(3) Separation from conductors of nonintrinsically safe circuits by use of an approved insulating partition.

(4) Where either (1) all of the intrinsically safe circuit conductors or (2) all of the nonintrinsically safe circuit conductors are in grounded metal-sheathed or metal-clad cables where the sheathing or cladding is capable of carrying fault current to ground.

Informational Note No. 1: Cables meeting the requirements of Articles 330 and 332 are typical of those considered acceptable.

Informational Note No. 2: The use of separate wiring compartments for the intrinsically safe and nonintrinsically safe terminals is a typical method of complying with this requirement.

Informational Note No. 3: Physical barriers such as grounded metal partitions or approved insulating partitions or approved restricted access wiring ducts separated from other such ducts by at least 19 mm (¾ in.) can be used to help ensure the required separation of the wiring.

(3) **Other (Not in Raceway or Cable Tray Systems)**. Conductors and cables of intrinsically safe circuits run in other than raceway or cable tray systems shall be separated by at least 50 mm (2 in.) and secured from conductors and cables of any nonintrinsically safe circuits.

Exception. Where either (1) all of the intrinsically safe circuit conductors are in Type MI or MC cables or (2) all of the nonintrinsically safe circuit conductors are in raceways or Type MI or MC cables where the sheathing or cladding is capable of carrying fault current to ground.

Changed From NEC 2008

504.30(B) **From Different Intrinsically Safe Circuit Conductors**: This was revised to include provision for clearance between field wiring terminals of different intrinsically safe circuits as part of the general requirement that references the methods of separation in (1) & (2).

NEC Language

(B) From Different Intrinsically Safe Circuit Conductors. The clearance between two terminals for connection of field wiring of different intrinsically safe circuits shall be at least 6 mm (0.25 in.), unless this clearance is permitted to be reduced by the control drawing. Different intrinsically safe circuits shall be separated from each other by one of the following means:

- (1) The conductors of each circuit are within a grounded metal shield.
- (2) The conductors of each circuit have insulation with a minimum thickness of 0.25 mm (0.01 in.).

Exception: Unless otherwise identified.

ARTICLE 505 — Zone 0, 1, and 2 Locations

This article covers the requirements for the zone classification system as an alternative to the division classification system covered in Article 500 for electrical and electronic equipment and wiring for all voltages in Class I, Zone 0, Zone 1, and Zone 2 hazardous (classified) locations where fire or explosion hazards may exist due to flammable gases, vapors, or liquids.

Informational Note: Refer to Articles 500 through 504 for the requirements for electrical and electronic equipment and wiring for all voltages in Class I, Division 1 or Division 2; Class II, Division 1 or Division 2; and Class III, Division 1 or Division 2 hazardous (classified) locations where fire or explosion hazards may exist due to flammable gases or vapors, flammable liquids, or combustible dusts or fibers

Changed From NEC 2008

505: The NEC revised informational notes to correlate with current titles of standards referenced therein.

NEC Language

Informational Note: Text that is followed by a reference in brackets has been extracted from NFPA 497-2008, Recommended Practice for the Classification of Flammable Liquids, Gases, or Vapors and of Hazardous (Classified) Locations for Electrical Installations in Chemical Process Areas. Only editorial changes were made to the extracted text to make it consistent with this Code.

505.7 Special Precaution**Changed From NEC 2008**

505.7: The NEC added a new requirement covering simultaneous presence of flammable gases and combustible dusts or fibers/flyings in Class I, Zone 0, 1, and 2 locations.

NEC Language

Article 505 requires equipment construction and installation that ensures safe performance under conditions of proper use and maintenance.

Informational Note No. 1: It is important that inspection authorities and users exercise more than ordinary care with regard to the installation and maintenance of electrical equipment in hazardous (classified) locations.

Informational Note No. 2: Low ambient conditions require special consideration. Electrical equipment depending on the protection techniques described by 505.8(A) may not be suitable for use at temperatures lower than -20°C (-4°F) unless they are identified for use at lower temperatures. However, at low ambient temperatures, flammable concentrations of vapors may not exist in a location classified Class I, Zones 0, 1, or 2 at normal ambient temperature.

(A) **Implementation of Zone Classification System.** Classification of areas, engineering and design, selection of equipment and wiring methods, installation, and inspection shall be performed by qualified persons.

(B) **Dual Classification.** In instances of areas within the same facility classified separately, Class I, Zone 2 locations shall be permitted to abut, but not overlap, Class I, Division 2 locations. Class I, Zone 0 or Zone 1 locations shall not abut Class I, Division 1 or Division 2 locations.

(C) **Reclassification Permitted.** A Class I, Division 1 or Division 2 location shall be permitted to be reclassified as a Class I, Zone 0, Zone 1, or Zone 2 location, provided all of the space that is classified because of a single flammable gas or vapor source is reclassified under the requirements of this article.

(D) **Solid Obstacles.** Flameproof equipment with flanged joints shall not be installed such that the flange openings are closer than the distances shown in Table 505.7(D) to any solid obstacle that is not a part of the equipment (such as steelworks, walls, weather guards, mounting brackets, pipes, or other electrical equipment) unless the equipment is listed for a smaller distance of separation.

Gas Group	Minimum Distance	
	mm	in.
IIC	40	1 ³⁷ / ₆₄
IIB	30	1 ³ / ₁₆
IIA	10	²⁵ / ₆₄

NEC 2011

(E) **Simultaneous Presence of Flammable Gases and Combustible Dusts or Fibers/Flyings.** Where flammable gases, combustible dusts, or fibers/flyings are or may be present at the same time, the simultaneous presence shall be considered during the selection and installation of the electrical equipment and the wiring methods, including the determination of the safe operating temperature of the electrical equipment.

505.8 Protection Techniques

NEC Language

Acceptable protection techniques for electrical and electronic equipment in hazardous (classified) locations shall be as described in 505.8(A) through (I).

Informational Note: For additional information, see ANSI/ISA-60079-0 (12.00.01)-2009, Electrical Apparatus for Use in Class I, Zones 0, 1, and 2 Hazardous (Classified) Locations, General Requirements; ANSI/ISA-12.01.01-1999, Definitions and Information Pertaining to Electrical Apparatus in Hazardous (Classified) Locations; and ANSI/UL 60079-0, Electrical Apparatus for Explosive Gas Atmospheres — Part 0: General Requirements.

(A) **Flameproof “d”**. This protection technique shall be permitted for equipment in Class I, Zone 1 or Zone 2 locations.

(B) **Purged and Pressurized**. This protection technique shall be permitted for equipment in those Class I, Zone 1 or Zone 2 locations for which it is identified.

(C) **Intrinsic Safety**. This protection technique shall be permitted for apparatus and associated apparatus in Class I, Zone 0, Zone 1, or Zone 2 locations for which it is listed.

(D) **Type of Protection “n”**. This protection technique shall be permitted for equipment in Class I, Zone 2 locations. Type of protection “n” is further subdivided into nA, nC, and nR.

Informational Note: See Table 505.9(C)(2)(4) for the descriptions of subdivisions for type of protection “n”.

(E) **Oil Immersion “o”**. This protection technique shall be permitted for equipment in Class I, Zone 1 or Zone 2 locations.

(F) **Increased Safety “e”**. This protection technique shall be permitted for equipment in Class I, Zone 1 or Zone 2 locations.

Changed From NEC 2008

505.8(G) Encapsulation “m” : This was revised to permit encapsulation as a protection technique in Zone 0 locations.

NEC Language

(G) **Encapsulation “m”**. This protection technique shall be permitted for equipment in Class I, Zone 0, Zone 1, or Zone 2 locations for which it is identified.

Informational Note: See Table 505.9(C)(2)(4) for the descriptions of subdivisions for encapsulation.

(H) **Powder Filling “q”**. This protection technique shall be permitted for equipment in Class I, Zone 1 or Zone 2 locations.

(I) **Combustible Gas Detection System**. A combustible gas detection system shall be permitted as a means of protection in industrial establishments with restricted public access and where the conditions of maintenance and

supervision ensure that only qualified persons service the installation. Where such a system is installed, equipment specified in 505.8(I)(1), (I)(2), or (I)(3) shall be permitted. The type of detection equipment, its listing, installation location(s), alarm and shutdown criteria, and calibration frequency shall be documented when combustible gas detectors are used as a protection technique.

Informational Note No. 1: For further information, see ANSI/API RP 505-1997, Recommended Practice for Classification of Locations for Electrical Installations at Petroleum Facilities Classified as Class I, Zone 0, Zone 1, and Zone 2.

Informational Note No. 2: For further information, see ANSI/ISA-60079-29-2, Explosive Atmospheres - Part 29-2. Gas detectors - Selection, installation, use and maintenance of detectors for flammable gases and oxygen.

Informational Note No. 3: For further information, see ISA-TR12.13.03, Guide for Combustible Gas Detection as a Method of Protection.

(1) **Inadequate Ventilation.** In a Class I, Zone 1 location that is so classified due to inadequate ventilation, electrical equipment suitable for Class I, Zone 2 locations shall be permitted. Combustible gas detection equipment shall be listed for Class I, Zone 1, for the appropriate material group, and for the detection of the specific gas or vapor to be encountered.

(2) **Interior of a Building.** In a building located in, or with an opening into, a Class I, Zone 2 location where the interior does not contain a source of flammable gas or vapor, electrical equipment for unclassified locations shall be permitted. Combustible gas detection equipment shall be listed for Class I, Zone 1 or Class I, Zone 2, for the appropriate material group, and for the detection of the specific gas or vapor to be encountered.

(3) **Interior of a Control Panel.** In the interior of a control panel containing instrumentation utilizing or measuring flammable liquids, gases, or vapors, electrical equipment suitable for Class I, Zone 2 locations shall be permitted. Combustible gas detection equipment shall be listed for Class I, Zone 1, for the appropriate material group, and for the detection of the specific gas or vapor to be encountered.

505.9 Equipment

NEC Language

(A) **Suitability.** Suitability of identified equipment shall be determined by one of the following:

- (1) Equipment listing or labeling
- (2) Evidence of equipment evaluation from a qualified testing laboratory or inspection agency concerned with product evaluation
- (3) Evidence acceptable to the authority having jurisdiction such as a manufacturer's self-evaluation or an owner's engineering judgment

Informational Note: Additional documentation for equipment may include certificates demonstrating compliance with applicable equipment standards, indicating special conditions of use, and other pertinent information.

(B) Listing.

(1) Equipment that is listed for a Zone 0 location shall be permitted in a Zone 1 or Zone 2 location of the same gas or vapor, provided that it is installed in accordance with the requirements for the marked type of protection. Equipment that is listed for a Zone 1 location shall be permitted in a Zone 2 location of the same gas or vapor, provided that it is installed in accordance with the requirements for the marked type of protection.

(2) Equipment shall be permitted to be listed for a specific gas or vapor, specific mixtures of gases or vapors, or any specific combination of gases or vapors.

Informational Note: One common example is equipment marked for "IIB. + H2."

(C) Marking. Equipment shall be marked in accordance with 505.9(C)(1) or (C)(2).

(1) **Division Equipment.** Equipment identified for Class I, Division 1 or Class I, Division 2 shall, in addition to being marked in accordance with 500.8(C), be permitted to be marked with all of the following:

- (1) Class I, Zone 1 or Class I, Zone 2 (as applicable)
- (2) Applicable gas classification group(s) in accordance with Table 505.9(C)(1)(2)
- (3) Temperature classification in accordance with 505.9(D)(1)

Table 505.9(C)(1)(2) Gas Classification Groups

Gas Group	Comment
IIC	See 505.6(A)
IIB	See 505.6(B)
IIA	See 505.6(C)

NEC 2011

Changed From NEC 2008

505.9(C)(2) **Zone Equipment:** This was revised to include protection techniques "ic" and "[ic]" for Groups IIA, IIB, and IIC equipment.

NEC Language

(2) **Zone Equipment.** Equipment meeting one or more of the protection techniques described in 505.8 shall be marked with all of the following in the order shown:

- (1) Class
- (2) Zone

- (3) Symbol “AEx”
- (4) Protection technique(s) in accordance with Table 505.9(C)(2)(4)
- (5) Applicable gas classification group(s) in accordance with Table 505.9(C)(1)(2)
- (6) Temperature classification in accordance with 505.9(D)(1)

Exception No. 1: Associated apparatus NOT suitable for installation in a hazardous (classified) location shall be required to be marked only with (3), (4), and (5), but BOTH the symbol AEx (3) and the symbol for the type of protection (4) shall be enclosed within the same square brackets, for example, [AEx ia] IIC.

Exception No. 2: Simple apparatus as defined in 504.2 shall not be required to have a marked operating temperature or temperature class.

Electrical equipment of types of protection “e,” “m,” “ma,” “mb,” “px,” “py,” “pz,” or “q” shall be marked Group II. Electrical equipment of types of protection “d,” “ia,” “ib,” “ic,” [ia], “[ib],” or “[ic]” shall be marked Group IIA, IIB, or IIC, or for a specific gas or vapor. Electrical equipment of types of protection “n” shall be marked Group II unless it contains enclosed-break devices, nonincendive components, or energy-limited equipment or circuits, in which case it shall be marked Group IIA, IIB, or IIC, or a specific gas or vapor. Electrical equipment of other types of protection shall be marked Group II unless the type of protection utilized by the equipment requires that it be marked Group IIA, IIB, or IIC, or a specific gas or vapor.

Informational Note No. 1: An example of the required marking for intrinsically safe apparatus for installation in Class I, Zone 0 is “Class I, Zone 0, AEx ia IIC T6.” An explanation of the marking that is required is shown in Informational Note Figure 505.9(C)(2).

Informational Note No. 2: An example of the required marking for intrinsically safe associated apparatus mounted in a flameproof enclosure for installation in Class I, Zone 1 is “Class I, Zone 1 AEx d[ia] IIC T4.”

Informational Note No. 3: An example of the required marking for intrinsically safe associated apparatus NOT for installation in a hazardous (classified) location is “[AEx ia] IIC.”

Informational Note No. 4: The EPL (or equipment protection level) may appear in the product marking. EPLs are designated as G for gas, D for dust, or M for mining and are then followed by a letter (a, b, or c) to give the user a better understanding as to whether the equipment provides either (a) a “very high,” (b) a “high,” or (c) an “enhanced” level of protection against ignition of an explosive atmosphere. For example, an AEx d IIC T4 motor (which is suitable by protection concept for application in Zone 1) may additionally be marked with an EPL of “Gb” to indicate that it was provided with a high level of protection, such as AEx d IIC T4 Gb.

Changed From NEC 2008

505.9(C)(2) Informational Note No. 5: The NEC added a new informational note explaining equipment marked “Class I, Zone 0/1”.

NEC Language

Informational Note No. 5: Equipment installed outside a Zone 0 location, electrically connected to equipment located inside a Zone 0 location, may be marked Class I, Zone 0/1. The “/” indicates that equipment contains a separation element and can be installed at the boundary between a Zone 0 and a Zone 1 location. See ANSI/ISA-60079-26, Electrical Apparatus for Use in Class I, Zone 0 Hazardous (Classified) Locations.

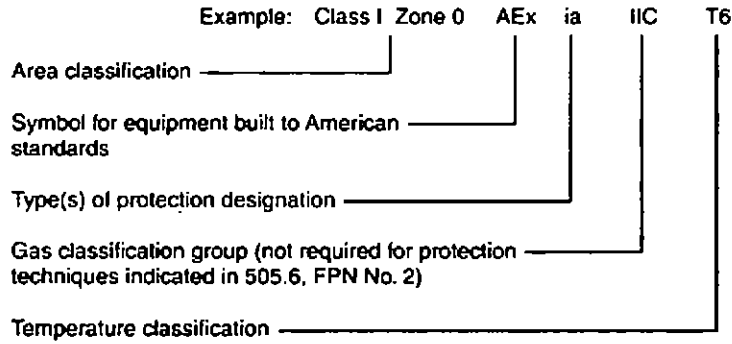

NEC 2011

Informational Note Figure 505.9(C)(2) Zone Equipment Marking.

Changed From NEC 2008

Table 505.9(C)(2)(4): This was revised to include current protection techniques for Class I, Zones 0, 1, & 2 locations.

Designation	Technique	Zone*
d	Flameproof enclosure	1
dh	Flameproof enclosure	1
e	Increased safety	1
eb	Increased safety	1
ia	Intrinsic safety	0
ib	Intrinsic safety	1
ic	Intrinsic safety	2
[ia]	Associated apparatus	Unclassified**
[ib]	Associated apparatus	Unclassified**
[ic]	Associated apparatus	Unclassified**
m	Encapsulation	1
ma	Encapsulation	0
mb	Encapsulation	1
nA	Nonsparking equipment	2
nA'	Nonsparking equipment	2
nC	Sparking equipment in which the contacts are suitably protected other than by restricted breathing enclosure	2
nCc	Sparking equipment in which the contacts are suitably protected other than by restricted breathing enclosure	2
nR	Restricted breathing enclosure	2
nRc	Restricted breathing enclosure	2
o	Oil immersion	1
ob	Oil immersion	1
px	Pressurization	1
pxb	Pressurization	1
py	Pressurization	1
pyb	Pressurization	1
pz	Pressurization	2
pzb	Pressurization	2
q	Powder filled	1
qb	Powder filled	1

*Does not address use where a combination of techniques is used.
 **Associated apparatus is permitted to be installed in a hazardous (classified) location if suitably protected using another type of protection.

NEC 2011

NEC Language

(D) **Class I Temperature.** The temperature marking specified below shall not exceed the ignition temperature of the specific gas or vapor to be encountered.

Informational Note: For information regarding ignition temperatures of gases and vapors, see NFPA 497-2008, Recommended Practice for the Classification of Flammable Liquids, Gases, or Vapors and of Hazardous (Classified) Locations for Electrical Installations in Chemical Process Areas; and IEC 60079-20-1996, Electrical Apparatus for Explosive Gas Atmospheres, Data for Flammable Gases and Vapours, Relating to the Use of Electrical Apparatus.

(1) **Temperature Classifications.** Equipment shall be marked to show the operating temperature or temperature class referenced to a 40°C ambient, or at the higher ambient temperature if the equipment is rated and marked for an ambient temperature of greater than 40°C. The temperature class, if provided, shall be indicated using the temperature class (T Code) shown in Table 505.9(D)(1).

Table 505.9(D)(1) Classification of Maximum Surface Temperature for Group II Electrical Equipment	
Temperature Class (T Code)	Maximum Surface Temperature (°C)
T1	≤450
T2	≤300
T3	≤200
T4	≤135
T5	≤100
T6	≤85

NEC 2011

Electrical equipment designed for use in the ambient temperature range between -20°C and +40°C shall require no ambient temperature marking.

Electrical equipment that is designed for use in a range of ambient temperatures other than -20°C to +40°C is considered to be special; and the ambient temperature range shall then be marked on the equipment, including either the symbol "Ta" or "Tamb" together with the special range of ambient temperatures, in degrees Celsius.

Informational Note: As an example, such a marking might be "-30°C to +40°C."

Exception No. 1: Equipment of the non-heat-producing type, such as conduit fittings, and equipment of the heat-producing type having a maximum temperature of not more than 100°C (212°F) shall not be required to have a marked operating temperature or temperature class.

Exception No. 2: Equipment identified for Class I, Division 1 or Division 2 locations as permitted by 505.20(B) and (D) shall be permitted to be marked in accordance with 500.8(C) and Table 500.8(C).

Changed From NEC 2008

505.9(E) Threading: This was revised to require entry threads to be either NPT or metric. Requirement for thread engagement and related exception relocated to 505.9(E)(1).

NEC Language

(E) **Threading.** The supply connection entry thread form shall be NPT or metric. Conduit and fittings shall be made wrenchtight to prevent sparking when fault current flows through the conduit system, and to ensure the explosionproof or flameproof integrity of the conduit system where applicable. Equipment provided

with threaded entries for field wiring connections shall be installed in accordance with 505.9(E)(1) or (E)(2) and with (E)(3).

(1) **Equipment Provided with Threaded Entries for NPT Threaded Conduit or Fittings.** For equipment provided with threaded entries for NPT threaded conduit or fittings, listed conduit, conduit fittings, or cable fittings shall be used.

All NPT threaded conduit and fittings referred to herein shall be threaded with a National (American) Standard Pipe Taper (NPT) thread.

NPT threaded entries into explosionproof or flameproof equipment shall be made up with at least five threads fully engaged.

Exception: For listed explosionproof or flameproof equipment, factory threaded NPT entries shall be made up with at least 4½ threads fully engaged.

Informational Note No. 1: Thread specifications for male NPT threads are located in ANSI/ASME B1.20.1-1983, Pipe Threads, General Purpose (Inch).

Changed From NEC 2008

505.9(E)(1) Informational Note No. 2: The NEC added a new informational note covering industry standards for female threaded entries.

NEC Language

Informational Note No. 2: Female NPT threaded entries use a modified National Standard Pipe Taper (NPT) thread with thread form per ANSI/ASME B1.20.1-1983, Pipe Threads, General Purpose (Inch). See ANSI UL/ISA 60079-1, Electrical Apparatus for Explosive Gas Atmospheres – Part 1: Flameproof Enclosures "d".

Changed From NEC 2008

505.9(E)(2) Equipment Provided with Threaded Entries for Metric Threaded Conduit or Fittings: This was revised to require listed conduit or cable fittings with equipment having metric threaded entries and to provide requirements covering thread engagement for explosionproof or flameproof equipment having metric threaded entries.

NEC Language

(2) **Equipment Provided with Threaded Entries for Metric Threaded Conduit or Fittings.** For equipment with metric threaded entries, listed conduit fittings or listed cable fittings shall be used. Such entries shall be identified as being metric, or listed adapters to permit connection to conduit or NPT threaded fittings shall be provided with the equipment and shall be used for connection to conduit or NPT threaded fittings.

Metric threaded entries into explosionproof or flameproof equipment shall have a class of fit of at least 6g/6H and be made up with at least five threads fully engaged for Groups C, D, IIB, or IIA and not less than eight threads fully engaged for Groups A, B, IIC, or IIB + H2.

Informational Note: Threading specifications for metric threaded entries are located in ISO 965/1-1980, ISO general purpose metric screw threads — Tolerances — Part 1: Principles and basic data, and ISO 965-3-1998, ISO general purpose metric screw

threads — Tolerances — Part 3: Deviations for constructional screw threads; and ISO 965/3-1980, Metric Screw Threads.

Changed From NEC 2008

505.9(E)(3) **Unused Openings:** The NEC added a new requirement covering use of listed metal close-up plugs and thread engagement.

NEC Language

(3) **Unused Openings.** All unused openings shall be closed with close-up plugs listed for the location and shall maintain the type of protection. The plug engagement shall comply with 505.9(E)(1) or 505.9(E)(2).

505.15 Wiring Methods

NEC Language

Wiring methods shall maintain the integrity of protection techniques and shall comply with 505.15(A) through (C).

(A) **Class I, Zone 0.** In Class I, Zone 0 locations, only intrinsically safe wiring methods in accordance with Article 504 shall be permitted.

Informational Note: Article 504 only includes protection technique "ia."

(B) Class I, Zone 1.

(1) **General.** In Class I, Zone 1 locations, the wiring methods in (B)(1)(a) through (B)(1)(f) shall be permitted.

(a) All wiring methods permitted by 505.15(A).

Changed From NEC 2008

505.15(B)(1)(b) : This was revised to reference installation requirements contained in Article 330 and to require use of listed termination fittings.

NEC Language

(b) In industrial establishments with restricted public access, where the conditions of maintenance and supervision ensure that only qualified persons service the installation, and where the cable is not subject to physical damage, Type MC-HL cable listed for use in Class I, Zone 1 or Division 1 locations, with a gas/vaportight continuous corrugated metallic sheath, an overall jacket of suitable polymeric material, and a separate equipment grounding conductor(s) in accordance with 250.122, and terminated with fittings listed for the application.

Type MC-HL cable shall be installed in accordance with the provisions of Article 330, Part II.

Changed From NEC 2008

505.15(B)(1)(c): This was revised to reference installation requirements contained in Article 727 and to require use of listed termination fittings.

NEC Language

(c) In industrial establishments with restricted public access, where the conditions of maintenance and supervision ensure that only qualified persons service the installation, and where the cable is not subject to physical damage, Type ITC-HL cable listed for use in Class I, Zone 1 or Division 1 locations, with a gas/vaportight continuous corrugated metallic sheath and an overall jacket of suitable polymeric material, and terminated with fittings listed for the application. Type ITC-HL cable shall be installed in accordance with the provisions of Article 727.

Informational Note: See 727.4 and 727.5 for restrictions on use of Type ITC cable.

(d) Type MI cable terminated with fittings listed for Class I, Zone 1 or Division 1 locations. Type MI cable shall be installed and supported in a manner to avoid tensile stress at the termination fittings.

(e) Threaded rigid metal conduit, or threaded steel intermediate metal conduit.

(f) Type PVC conduit and Type RTRC conduit shall be permitted where encased in a concrete envelope a minimum of 50 mm (2 in.) thick and provided with not less than 600 mm (24 in.) of cover measured from the top of the conduit to grade. Threaded rigid metal conduit or threaded steel intermediate metal conduit shall be used for the last 600 mm (24 in.) of the underground run to emergence or to the point of connection to the aboveground raceway. An equipment grounding conductor shall be included to provide for electrical continuity of the raceway system and for grounding of non-current-carrying metal parts.

Changed From NEC 2008

505.15(B)(2) **Flexible Connections:** This was revised to require listed cord connectors that maintain type of protection required for terminal compartment.

NEC Language

(2) **Flexible Connections.** Where necessary to employ flexible connections, flexible fittings listed for Class I, Zone 1 or Division 1 locations, or flexible cord in accordance with the provisions of 505.17 terminated with a listed cord connector that maintains the type of protection of the terminal compartment, shall be permitted.

(C) Class I, Zone 2.**Changed From NEC 2008**

505.15(C)(1) **General:** This was revised to include ITC-ER and PLTC-ER cables terminated with listed fittings.

NEC Language

(1) **General.** In Class I, Zone 2 locations, the following wiring methods shall be permitted.

(a) All wiring methods permitted by 505.15(B).

- (b) Types MC, MV, or TC cable, including installation in cable tray systems. The cable shall be terminated with listed fittings. Single conductor Type MV cables shall be shielded or metallic-armored.
- (c) Type ITC and Type ITC-ER cable as permitted in 727.4 and terminated with listed fittings.
- (d) Type PLTC and Type PLTC-ER cable in accordance with the provisions of Article 725, including installation in cable tray systems. The cable shall be terminated with listed fittings.
- (e) Enclosed gasketed busways, enclosed gasketed wireways.

Changed From NEC 2008

505.15(C)(1)(f): This was revised to require RTRC conduit be listed.

NEC Language

(f) In industrial establishments with restricted public access, where the conditions of maintenance and supervision ensure that only qualified persons service the installation, and where metallic conduit does not provide sufficient corrosion resistance, listed reinforced thermosetting resin conduit (RTRC), factory elbows, and associated fittings, all marked with the suffix -XW, and Schedule 80 PVC conduit, factory elbows, and associated fittings shall be permitted. Where seals are required for boundary conditions as defined in 505.16(C)(1)(b), the Zone 1 wiring method shall extend into the Zone 2 area to the seal, which shall be located on the Zone 2 side of the Zone 1–Zone 2 boundary.

Changed From NEC 2008

505.15(C)(1)(g): This was revised from "*nonincendive*" to protection technique "*ic*" (intrinsic safety).

NEC Language

(g) Intrinsic safety type of protection "*ic*" shall be permitted using any of the wiring methods permitted for unclassified locations. Intrinsic safety type of protection "*ic*" systems shall be installed in accordance with the control drawing(s). Simple apparatus, not shown on the control drawing, shall be permitted in an intrinsic safety type of protection "*ic*" circuit, provided the simple apparatus does not interconnect the intrinsic safety type of protection "*ic*" systems to any other circuit.

Informational Note: Simple apparatus is defined in 504.2.

Separate intrinsic safety type of protection "*ic*" systems shall be installed in accordance with one of the following:

- (1) In separate cables
- (2) In multiconductor cables where the conductors of each circuit are within a grounded metal shield

(3) In multiconductor cables where the conductors of each circuit have insulation with a minimum thickness of 0.25 mm (0.01 in.)

Changed From NEC 2008

505.15(C)(2) **Flexible Connections:** This was revised to require listed cord connectors.

NEC Language

(2) **Flexible Connections.** Where provision must be made for limited flexibility, flexible metal fittings, flexible metal conduit with listed fittings, liquidtight flexible metal conduit with listed fittings, liquidtight flexible nonmetallic conduit with listed fittings, or flexible cord in accordance with the provisions of 505.17 terminated with a listed cord connector that maintains the type of protection of the terminal compartment shall be permitted.

Informational Note: See 505.25(B) for grounding requirements where flexible conduit is used.

505.17 Flexible Cords, Class I, Zones 1 and 2

NEC Language

A flexible cord shall be permitted for connection between portable lighting equipment or other portable utilization equipment and the fixed portion of their supply circuit. Flexible cord shall also be permitted for that portion of the circuit where the fixed wiring methods of 505.15(B) cannot provide the necessary degree of movement for fixed and mobile electrical utilization equipment, in an industrial establishment where conditions of maintenance and engineering supervision ensure that only qualified persons install and service the installation, and the flexible cord is protected by location or by a suitable guard from damage. The length of the flexible cord shall be continuous. Where flexible cords are used, the cords shall comply with the following:

- (1) Be of a type listed for extra-hard usage
- (2) Contain, in addition to the conductors of the circuit, an equipment grounding conductor complying with 400.23
- (3) Be connected to terminals or to supply conductors in an approved manner
- (4) Be supported by clamps or by other suitable means in such a manner that there will be no tension on the terminal connections

Changed From NEC 2008

505.17(5): This was revised to require listed cord connectors.

NEC Language

(5) Be terminated with a *listed cord connector* that maintains the type of protection where the flexible cord enters boxes, fittings, or enclosures that are required to be explosionproof or flameproof

(6) Cord entering an increased safety “e” enclosure shall be terminated with a listed increased safety “e” cord connector.

Informational Note: See 400.7 for permitted uses of flexible cords.

Electric submersible pumps with means for removal without entering the wet-pit shall be considered portable utilization equipment. The extension of the flexible cord within a suitable raceway between the wet-pit and the power source shall be permitted.

Electric mixers intended for travel into and out of open-type mixing tanks or vats shall be considered portable utilization equipment.

Informational Note: See 505.18 for flexible cords exposed to liquids having a deleterious effect on the conductor insulation.

505.25 Grounding and Bonding

NEC Language

Grounding and bonding shall comply with Article 250 and the requirements in 505.25(A) and (B).

(A) **Bonding.** The locknut-bushing and double-locknut types of contacts shall not be depended on for bonding purposes, but bonding jumpers with proper fittings or other approved means of bonding shall be used. Such means of bonding shall apply to all intervening raceways, fittings, boxes, enclosures, and so forth, between Class I locations and the point of grounding for service equipment or point of grounding of a separately derived system.

Exception: The specific bonding means shall be required only to the nearest point where the grounded circuit conductor and the grounding electrode are connected together on the line side of the building or structure disconnecting means as specified in 250.32(B), provided the branch-circuit overcurrent protection is located on the load side of the disconnecting means.

Informational Note: See 250.100 for additional bonding requirements in hazardous (classified) locations.

Changed From NEC 2008

505.25(B) Types of Equipment Grounding Conductors: This was revised to require installation of a wire-type equipment bonding jumper.

NEC Language

(B) **Types of Equipment Grounding Conductors.** Flexible metal conduit and liquidtight flexible metal conduit shall include an equipment bonding jumper of the wire type in compliance with 250.102.

Exception: In Class I, Zone 2 locations, the bonding jumper shall be permitted to be deleted where all of the following conditions are met:

- (a) Listed liquidtight flexible metal conduit 1.8 m (6 ft) or less in length, with fittings listed for grounding, is used.
- (b) Overcurrent protection in the circuit is limited to 10 amperes or less.
- (c) The load is not a power utilization load.

505.26 Process Sealing

Changed From NEC 2008

505.26: The NEC relocated requirements for process sealing from 505.16(E)(3) and to add requirements covering listed Type MI cable assembly.

NEC Language

This section shall apply to process-connected equipment, which includes, but is not limited to, canned pumps, submersible pumps, flow, pressure, temperature, or analysis measurement instruments. A process seal is a device to prevent the migration of process fluids from the designed containment into the external electrical system. Process connected electrical equipment that incorporates a single process seal, such as a single compression seal, diaphragm, or tube to prevent flammable or combustible fluids from entering a conduit or cable system capable of transmitting fluids, shall be provided with an additional means to mitigate a single process seal failure. The additional means may include, but is not limited to the following:

- (1) A suitable barrier meeting the process temperature and pressure conditions that the barrier is subjected to upon failure of the single process seal. There shall be a vent or drain between the single process seal and the suitable barrier. Indication of the single process seal failure shall be provided by visible leakage, an audible whistle, or other means of monitoring.
- (2) A listed Type MI cable assembly, rated at not less than 125 percent of the process pressure and not less than 125 percent of the maximum process temperature (in degrees Celsius), installed between the cable or conduit and the single process seal.
- (3) A drain or vent located between the single process seal and a conduit or cable seal. The drain or vent shall be sufficiently sized to prevent overpressuring the conduit or cable seal above 6 in. water column (1493 Pa). Indication of the single process seal failure shall be provided by visible leakage, an audible whistle, or other means of monitoring.

Process-connected electrical equipment that does not rely on a single process seal or is listed and marked "single seal" or "dual seal" shall not be required to be provided with an additional means of sealing.

Informational Note: For construction and testing requirements for process sealing for listed and marked "single seal" or "dual seal" requirements, refer to ANSI/ISA-12.27.01-2003, Requirements for Process Sealing Between Electrical Systems and Potentially Flammable or Combustible Process Fluids.

ARTICLE 506 — Zone 20, 21, and 22 Locations for Combustible Dusts or Ignitable Fibers/Flyings

This article covers the requirements for the zone classification system as an alternative to the division classification system covered in Article 500, Article 502, and Article 503 for electrical and electronic equipment and wiring for all voltages in Zone 20, Zone 21, and Zone 22 hazardous (classified) locations where fire and explosion hazards may exist due to combustible dusts or ignitable fibers/flyings.

Combustible metallic dusts are not covered by the requirements of this article.

Changed From NEC 2008

506: This was revised informational notes to correlate with current titles of standards referenced therein.

NEC Language

Informational Note: Text that is followed by a reference in brackets has been extracted from NFPA 499-2008, Recommended Practice for the Classification of Combustible Dusts and of Hazardous (Classified) Locations for Electrical Installation in Chemical Process Areas. Only editorial changes were made to the extracted text to make it consistent with this Code.

506.2 Definitions

NEC Language

For purposes of this article, the following definitions apply.

Associated Nonincendive Field Wiring Apparatus. Apparatus in which the circuits are not necessarily nonincendive themselves but that affect the energy in nonincendive field wiring circuits and are relied upon to maintain nonincendive energy levels. Associated nonincendive field wiring apparatus may be either of the following:

- (1) Electrical apparatus that has an alternative type of protection for use in the appropriate hazardous (classified) location
- (2) Electrical apparatus not so protected that shall not be used in a hazardous (classified) location

Informational Note: Associated nonincendive field wiring apparatus has designated associated nonincendive field wiring apparatus connections for nonincendive field wiring apparatus and may also have connections for other electrical apparatus.

Changed From NEC 2008

506.2 Combustible Dust: The NEC added a new definition (extracted from NFPA 499) for consistency between area classification provisions in NFPA 499 and installation requirements in the NEC.

NEC Language

Combustible Dust. Any finely divided solid material that is 420 microns (0.017 in.) or smaller in diameter (material passing a U.S. No. 40 Standard Sieve) and presents a fire or explosion hazard when dispersed and ignited in air. [499:3.3.3]

506.8 Protection Techniques**NEC Language**

Acceptable protection techniques for electrical and electronic equipment in hazardous (classified) locations shall be as described in 506.8(A) through (J).

(A) **Dust Ignitionproof.** This protection technique shall be permitted for equipment in Zone 20, Zone 21, and Zone 22 locations for which it is identified.

(B) **Pressurized.** This protection technique shall be permitted for equipment in Zone 21 and Zone 22 locations for which it is identified.

(C) **Intrinsic Safety.** This protection technique shall be permitted for equipment in Zone 20, Zone 21, and Zone 22 locations for which it is identified. Installation of intrinsically safe apparatus and wiring shall be in accordance with the requirements of Article 504.

(D) **Dusttight.** This protection technique shall be permitted for equipment in Zone 22 locations for which it is identified.

Changed From NEC 2008

506.8(E) & **Informational Note:** This was revised to include all levels for protection technique "mD". New informational added to reference Table 506.9(C)(2)(3).

NEC Language

(E) **Protection by Encapsulation "mD".** This protection technique shall be permitted for equipment in Zone 20, Zone 21, and Zone 22 locations for which it is identified.

Informational Note: See Table 506.9(C)(2)(3) for the descriptions of subdivisions for encapsulation.

506.9 Equipment Requirements

(A) **Suitability.** Suitability of identified equipment shall be determined by one of the following:

- (1) Equipment listing or labeling
- (2) Evidence of equipment evaluation from a qualified testing laboratory or inspection agency concerned with product evaluation
- (3) Evidence acceptable to the authority having jurisdiction such as a manufacturer's self-evaluation or an owner's engineering judgment

Informational Note: Additional documentation for equipment may include certificates demonstrating compliance with applicable equipment standards, indicating special conditions of use, and other pertinent information.

(B) Listing.

- (1) Equipment that is listed for Zone 20 shall be permitted in a Zone 21 or Zone 22 location of the same dust or ignitable fiber/flying. Equipment that is listed for Zone 21 may be used in a Zone 22 location of the same dust fiber/flying.
- (2) Equipment shall be permitted to be listed for a specific dust or ignitable fiber/flying or any specific combination of dusts fibers/flyings.

(C) Marking.

(1) **Division Equipment.** Equipment identified for Class II, Division 1 or Class II, Division 2 shall, in addition to being marked in accordance with 500.8(C), be permitted to be marked with both of the following:

- (1) Zone 20, 21, or 22 (as applicable)
- (2) Temperature classification in accordance with 506.9(D)

(2) **Zone Equipment.** Equipment meeting one or more of the protection techniques described in 506.8 shall be marked with the following in the order shown:

- (1) Zone
- (2) Symbol "AEx"
- (3) Protection technique(s) in accordance with Table 506.9(C)(2)(3)
- (4) Temperature classification, marked as a temperature value, in degrees C, preceded by T
- (5) Ambient temperature marking in accordance with 506.9(D)

Changed From NEC 2008

506.9(C)(2) **Informational Note:** The NEC added a new informational note to explain use of EPL (equipment protection level) in product marking.

NEC Language

Informational Note: The EPL (or equipment protection level) may appear in the product marking. EPLs are designated as G for gas, D for dust, or M for mining, and are then followed by a letter (a, b, or c) to give the user a better understanding as to whether the equipment provides either (a) a "very high," (b) "high," or (c) an "enhanced" level of protection against ignition of an explosive atmosphere. For example, an AEx pb IIIB T165°C motor (which is suitable by protection concept for application in Zone 21) may additionally be marked with an EPL of "Db", AEx p IIIB T165°C Db.

Changed From NEC 2008

Table 506.9(C)(2)(3): This was revised to include current protection techniques for Class I, Zones 0, 1, & 2 locations.

Designation	Technique	Zone*
iaD	Protection by intrinsic safety	20
ia	Protection by intrinsic safety	20
ibD	Protection by intrinsic safety	21
ib	Protection by intrinsic safety	21
[iaD]	Associated apparatus	Unclassified**
[ia]	Associated apparatus	Unclassified**
[ibD]	Associated apparatus	Unclassified**
[ib]	Associated apparatus	Unclassified**
maD	Protection by encapsulation	20
ma	Protection by encapsulation	20
mbD	Protection by encapsulation	21
mb	Protection by encapsulation	21
pD	Protection by pressurization	21
p	Protection by pressurization	21
ph	Protection by pressurization	21
tD	Protection by enclosures	21
ta	Protection by enclosures	21
tb	Protection by enclosures	21
tc	Protection by enclosures	22

*Does not address use where a combination of techniques is used.
 **Associated apparatus is permitted to be installed in a hazardous (classified) location if suitably protected using another type of protection.

NEC 2011

Informational Note: The “D” suffix on the type of protection designation was employed prior to the introduction of Group IIIA, IIIB, and IIIC; which is now used to distinguish between the type of protection employed for Group II (Gases) or Group III (Dusts).

(D) Temperature Classifications. Equipment shall be marked to show the operating temperature referenced to a 40°C (104°F) ambient. Electrical equipment designed for use in the ambient temperature range between -20°C and +40°C shall require no additional ambient temperature marking. Electrical equipment that is designed for use in a range of ambient temperatures other than -20°C and +40°C is considered to be special; and the ambient temperature range shall then be marked on the equipment, including either the symbol “Ta” or “Tamb” together with the special range of ambient temperatures. As an example,

such a marking might be “–30°C Ta +40°C.” Electrical equipment suitable for ambient temperatures exceeding 40°C (104°F) shall be marked with both the maximum ambient temperature and the operating temperature at that ambient temperature.

Exception No. 1: Equipment of the non–heat-producing type, such as conduit fittings, shall not be required to have a marked operating temperature.

Exception No. 2: Equipment identified for Class II, Division 1 or Class II, Division 2 locations as permitted by 506.20(B) and (C) shall be permitted to be marked in accordance with 500.8(C) and Table 500.8(C).

Changed From NEC 2008

506.9(E) Threading: This was revised to require entry threads to be either NPT or metric.

NEC Language

(E) Threading. The supply connection entry thread form shall be NPT or metric. Conduit and fittings shall be made wrenchtight to prevent sparking when the fault current flows through the conduit system and to ensure the integrity of the conduit system. Equipment provided with threaded entries for field wiring connections shall be installed in accordance with 506.9(E)(1) or (E)(2) and with (E)(3).

(1) Equipment Provided with Threaded Entries for NPT Threaded Conduit or Fittings. For equipment provided with threaded entries for NPT threaded conduit or fittings, listed conduit fittings, or cable fittings shall be used. All NPT threaded conduit and fittings referred to herein shall be threaded with a National (American) Standard Pipe Taper (NPT) thread.

Informational Note: Thread specifications for NPT threads are located in ANSI/ASME B1.20.1-1983, Pipe Threads, General Purpose (Inch).

Changed From NEC 2008

506.9(E)(2) Equipment Provided with Threaded Entries for Metric Threaded Conduit or Fittings: This was revised to require listed conduit or cable fittings with equipment having metric threaded entries and to provide requirements covering thread engagement for equipment having metric threaded entries.

NEC Language

(2) Equipment Provided with Threaded Entries for Metric Threaded Conduit or Fittings. For equipment with metric threaded entries, listed conduit fittings or listed cable fittings shall be used. Such entries shall be identified as being metric, or listed adapters to permit connection to conduit or NPT threaded fittings shall be provided with the equipment and shall be used for connection to conduit or NPT threaded fittings. Metric threaded entries shall be made up with at least five threads fully engaged.

Changed From NEC 2008

506.9(E)(3) **Unused Openings:** The NEC added a new requirement covering use of listed metal close-up plugs and thread engagement.

NEC Language

(3) **Unused Openings.** All unused openings shall be closed with listed metal close-up plugs. The plug engagement shall comply with 506.9(E)(1) or (E)(2).

(F) **Optical Fiber Cables.** Where an optical fiber cable contains conductors that are capable of carrying current (composite optical fiber cable), the optical fiber cable shall be installed in accordance with the requirements of Articles 506.15 and 506.16.

506.15 Wiring Methods**NEC Language**

Wiring methods shall maintain the integrity of the protection techniques and shall comply with 506.15(A), (B), or (C).

(A) **Zone 20.** In Zone 20 locations, the following wiring methods shall be permitted.

- (1) Threaded rigid metal conduit or threaded steel intermediate metal conduit.
- (2) Type MI cable terminated with fittings listed for the location. Type MI cable shall be installed and supported in a manner to avoid tensile stress at the termination fittings.

Exception: MI cable and fittings listed for Class II, Division 1 locations shall be permitted to be used.

Changed From NEC 2008

506.15(A)(3): This was revised to reference installation requirements contained in Article 330 and to require the use of listed termination fittings.

NEC Language

(3) In industrial establishments with limited public access, where the conditions of maintenance and supervision ensure that only qualified persons service the installation, Type MC-HL cable listed for use in Zone 20 locations, with a continuous corrugated metallic sheath, an overall jacket of suitable polymeric material, and a separate equipment grounding conductor(s) in accordance with 250.122, and terminated with fittings listed for the application, shall be permitted. Type MC-HL cable shall be installed in accordance with the provisions of Article 330, Part II.

Exception: Type MC-HL cable and fittings listed for Class II, Division 1 locations shall be permitted to be used.

Changed From NEC 2008

506.15(A)(4): The NEC added a new requirement covering use and installation of ITC-HL cable.

NEC Language

(4) In industrial establishments with restricted public access, where the conditions of maintenance and supervision ensure that only qualified persons service the installation, and where the cable is not subject to physical damage, Type ITC-HL cable listed for use in Zone 1 or Class I, Division 1 locations, with a gas/vaportight continuous corrugated metallic sheath and an overall jacket of suitable polymeric material, and terminated with fittings listed for the application. Type ITC-HL cable shall be installed in accordance with the provisions of Article 727.

(5) Fittings and boxes shall be identified for use in Zone 20 locations.

Exception: Boxes and fittings listed for Class II, Division 1 locations shall be permitted to be used.

Changed From NEC 2008

506.15(A)(6): This was revised to require listed cord connectors that maintain type of protection required for terminal compartment.

NEC Language

(6) Where necessary to employ flexible connections, liquidtight flexible metal conduit with listed fittings, liquidtight flexible nonmetallic conduit with listed fittings, or flexible cord listed for extra-hard usage and provided with listed fittings shall be used. Where flexible cords are used, they shall also comply with 506.17 and shall be terminated with a listed cord connector that maintains the type of protection of the terminal compartment. Where flexible connections are subject to oil or other corrosive conditions, the insulation of the conductors shall be of a type listed for the condition or shall be protected by means of a suitable sheath.

Exception: Flexible conduit and flexible conduit and cord fittings listed for Class II, Division 1 locations shall be permitted to be used.

Informational Note: See 506.25 for grounding requirements where flexible conduit is used.

(B) **Zone 21.** In Zone 21 locations, the wiring methods in (B)(1) and (B)(2) shall be permitted.

(1) All wiring methods permitted in 506.15(A).

(2) Fittings and boxes that are dusttight, provided with threaded bosses for connection to conduit, in which taps, joints, or terminal connections are not made, and are not used in locations where metal dust is present, may be used.

(C) **Zone 22.** In Zone 22 locations, the following wiring methods shall be permitted.

(1) All wiring methods permitted in 506.15(B).

(2) Rigid metal conduit, intermediate metal conduit, electrical metallic tubing, dusttight wireways.

(3) Type MC or MI cable with listed termination fittings.

Changed From NEC 2008

506.15(C)(4) & (5): This was revised to include ITC-ER and PLTC-ER cables terminated with listed fittings.

NEC Language

(4) Type PLTC and Type PLTC-ER cable in accordance with the provisions of Article 725, including installation in cable tray systems. The cable shall be terminated with listed fittings.

(5) Type ITC and Type ITC-ER cable as permitted in 727.4 and terminated with listed fittings.

(6) Type MC, MI, MV, or TC cable installed in ladder, ventilated trough, or ventilated channel cable trays in a single layer, with a space not less than the larger cable diameter between two adjacent cables, shall be the wiring method employed. Single-conductor Type MV cables shall be shielded or metallic armored.

(7) Nonincendive field wiring shall be permitted using any of the wiring methods permitted for unclassified locations. Nonincendive field wiring systems shall be installed in accordance with the control drawing(s).

Simple apparatus, not shown on the control drawing, shall be permitted in a nonincendive field wiring circuit, provided the simple apparatus does not interconnect the nonincendive field wiring circuit to any other circuit.

Informational Note: Simple apparatus is defined in 504.2.

Separation of nonincendive field wiring circuits shall be in accordance with one of the following:

- a. Be in separate cables
- b. Be in multiconductor cables where the conductors of each circuit are within a grounded metal shield
- c. Be in multiconductor cables where the conductors have insulation with a minimum thickness of 0.25 mm (0.01 in.)

(8) Boxes and fittings shall be dusttight.

506.17 Flexible Cords

NEC Language

Flexible cords used in Zone 20, Zone 21, and Zone 22 locations shall comply with all of the following:

- (1) Be of a type listed for extra-hard usage
- (2) Contain, in addition to the conductors of the circuit, an equipment grounding conductor complying with 400.23
- (3) Be connected to terminals or to supply conductors in an approved manner

(4) Be supported by clamps or by other suitable means in such a manner to minimize tension on the terminal connections

Changed From NEC 2008

506.17(5): This was revised to require listed cord connectors that maintain type of protection required for terminal compartment.

NEC Language

(5) Be terminated with a listed cord connector that maintains the protection technique of the terminal compartment.

506.25 Grounding and Bonding

NEC Language

Grounding and bonding shall comply with Article 250 and the requirements in 506.25(A) and (B).

(A) **Bonding.** The locknut-bushing and double-locknut types of contacts shall not be depended on for bonding purposes, but bonding jumpers with proper fittings or other approved means of bonding shall be used. Such means of bonding shall apply to all intervening raceways, fittings, boxes, enclosures, and so forth, between Zone 20, Zone 21, and Zone 22 locations and the point of grounding for service equipment or point of grounding of a separately derived system.

Exception: The specific bonding means shall be required only to the nearest point where the grounded circuit conductor and the grounding electrode conductor are connected together on the line side of the building or structure disconnecting means as specified in 250.32(B) if the branch side overcurrent protection is located on the load side of the disconnecting means.

Informational Note: See 250.100 for additional bonding requirements in hazardous (classified) locations.

Changed From NEC 2008

506.25(B) **Types of Equipment Grounding Conductors:** This was revised to require installation of a wire-type equipment bonding jumper.

NEC Language

(B) **Types of Equipment Grounding Conductors.** Liquidtight flexible metal conduit shall include an equipment bonding jumper of the wire type in compliance with 250.102.

Exception: In Zone 22 locations, the bonding jumper shall be permitted to be deleted where all of the following conditions are met:

- (1) Listed liquidtight flexible metal conduit 1.8 m (6 ft) or less in length, with fittings listed for grounding, is used.
- (2) Overcurrent protection in the circuit is limited to 10 amperes or less.
- (3) The load is not a power utilization load.

ARTICLE 511 — Commercial Garages, Repair and Storage

These occupancies include locations used for service and repair operations in connection with self-propelled vehicles (including, but not limited to, passenger automobiles, buses, trucks, and tractors) in which volatile flammable liquids or flammable gases are used for fuel or power.

Article 100 defines garage as “a building or portion of a building in which one or more self-propelled vehicles can be kept for use, sale, storage, rental, repair, exhibition, or demonstration purposes.” Article 511 applies to commercial garages in which the primary operation is the service and repair of self-propelled vehicles that use flammable gases or liquids for fuel. These commercial garages include automotive service centers; repair garages for commercial vehicles, such as trucks and tractors; and service garages for fleet vehicles, such as buses, cars, and trucks.

The requirements of Article 511 are intended to mitigate the potential for an ignition-capable arc or spark from electrical wiring or equipment used in or above hazardous locations. Also covered are requirements for personnel protection in occupancies that are frequently wet or damp in which service personnel are subject to contact with large grounded surfaces, such as concrete slabs in direct contact with the earth. The increasing number of service operations in which minor repairs, such as oil changes, occur is covered under the requirements of this article plus the below grade work area classification requirements of Article 514. See 511.3 and its associated commentary.

Parking, storage, and similar occupancies are not required to be classified, provided that any repair that occurs is minor and does not involve the use of electrical equipment. In accordance with NFPA 88A, Standard for Parking Structures, a mechanical ventilating system that is capable of continuously providing a ventilation rate of 1 ft³ per minute for each square foot of floor area is required for all enclosed, basement, and underground parking garages.

Operations that involve open flames or electric arcs, including fusion gas welding and electric welding, as well as the requirements for heat-producing appliances, are found in *NFPA 30A, Code for Motor Fuel Dispensing Facilities and Repair Garages*. Repair work that involves an open flame or electric arcs must be restricted to areas specifically provided for such purposes.

Section 555.22 requires that the repair facilities for boats and other marine craft comply with the requirements of Article 511.

511.3 Area Classification, General

NEC Language

Where Class I liquids or gaseous fuels are stored, handled, or transferred, electrical wiring and electrical utilization equipment shall be designed in accordance with the requirements for Class I, Division 1 or 2 hazardous

(classified) locations as classified in accordance with 500.5 and 500.6, and this article. A Class I location shall not extend beyond an unpierced wall, roof, or other solid partition that has no openings. [30A:8.3.5, 8.3.2]

(A) **Parking Garages.** Parking garages used for parking or storage shall be permitted to be unclassified.

Informational Note: For further information, see NFPA 88A-2011, Standard for Parking Structures, and NFPA 30A-2008, Code for Motor Fuel Dispensing Facilities and Repair Garages.

(B) **Repair Garages, With Dispensing.** Major and minor repair garages that dispense motor fuels into the fuel tanks of vehicles, including flammable liquids having a flash point below 38°C (100°F) such as gasoline, or gaseous fuels such as natural gas, hydrogen, or LPG, shall have the dispensing functions and components classified in accordance with Table 514.3(B)(1) in addition to any classification required by this section. Where Class I liquids, other than fuels, are dispensed, the area within 900 mm (3 ft) of any fill or dispensing point, extending in all directions, shall be a Class I, Division 2 location.

(C) **Major Repair Garages.** Where flammable liquids having a flash point below 38°C (100°F) such as gasoline, or gaseous fuels such as natural gas, hydrogen, or LPG, will not be dispensed, but repair activities that involve the transfer of such fluids or gases are performed, the classification rules in (1), (2), and (3) shall apply.

(1) **Floor Areas.**

(a) **Ventilation Provided.** The floor area shall be unclassified where there is mechanical ventilation providing a minimum of four air changes per hour or 0.3 m³/min/m² (1 cfm/ft²) of exchanged air for each square meter (foot) of floor area. Ventilation shall provide for air exchange across the entire floor area, and exhaust air shall be taken at a point within 0.3 m (12 in.) of the floor.

(b) **Ventilation Not Provided.** The entire floor area up to a level of 450 mm (18 in.) above the floor shall be classified as Class I, Division 2 if the ventilation does not comply with 511.3(C)(1)(a).

(2) **Ceiling Areas.** Where lighter-than-air gaseous fueled vehicles, such as vehicles fueled by natural gas or hydrogen, are repaired or stored, the area within 450 mm (18 in.) of the ceiling shall be considered for classification in accordance with (a) and (b).

Changed From NEC 2008

511.3(C)(2)(a) **Ventilation Provided:** The NEC Revised the requirement from "not less than 18 in." to "not more than 18."

NEC Language

(a) **Ventilation Provided.** The ceiling area shall be unclassified where ventilation is provided, from a point not more than 450 mm (18 in.) from the highest point in the ceiling, to exhaust the ceiling area at a rate of not less than 0.3 m³/min/m² (1

cfm/ft²) of ceiling area at all times that the building is occupied or when vehicles using lighter-than-air gaseous fuels are parked below this area.

ARTICLE 514 — Motor Fuel Dispensing Facilities

Article 514 covers facilities that dispense fuel from storage tanks into the fuel tanks of vehicles.

A large table makes up about half of this Article. This table classifies a motor fuel dispensing area based on the equipment contained herein. The rest of this article contains specific provisions, and refer to other articles that must be applied.

Note that diesel fuel is not considered a flammable liquid, therefore, diesel dispensing equipment and associate wiring are not required to comply with the hazardous location requirements of this article.

514.3 Classification of Locations

NEC Language

(A) **Unclassified Locations.** Where the authority having jurisdiction can satisfactorily determine that flammable liquids having a flash point below 38°C (100°F), such as gasoline, will not be handled, such location shall not be required to be classified.

(B) **Classified Locations.**

Changed From NEC 2008

514.3(B)(1) **Class I Locations:** The NEC revised Table 514.3(B)(1) based on 2008 edition of NFPA 30A.

NEC Language

(1) **Class I Locations.** Table 514.3(B)(1) shall be applied where Class I liquids are stored, handled, or dispensed and shall be used to delineate and classify motor fuel dispensing facilities and commercial garages as defined in Article 511. Table 515.3 shall be used for the purpose of delineating and classifying aboveground tanks. A Class I location shall not extend beyond an unpierced wall, roof, or other solid partition. [30A:8.1, 8.3]

(2) **Compressed Natural Gas, Liquefied Natural Gas, and Liquefied Petroleum Gas Areas.** Table 514.3(B)(2) shall be used to delineate and classify areas where compressed natural gas (CNG), liquefied natural gas (LNG), or liquefied petroleum gas (LPG) is stored, handled, or dispensed. Where CNG or LNG dispensers are installed beneath a canopy or enclosure, either the canopy or the enclosure shall be designed to prevent accumulation or entrapment of ignitable vapors, or all electrical equipment installed beneath the canopy or enclosure shall be suitable for Class I, Division 2 hazardous (classified) locations. Dispensing devices for liquefied petroleum gas shall be located not less than 1.5 m (5 ft) from any dispensing device for Class I liquids. [30A:12.1, 12.4, 12.5]

Informational Note No. 1: For information on area classification where liquefied petroleum gases are dispensed, see NFPA 58-2011, Liquefied Petroleum Gas Code.

Informational Note No. 2: For information on classified areas pertaining to LP-Gas systems other than residential or commercial, see NFPA 58-2011, Liquefied Petroleum Gas Code, and NFPA 59-2008, Utility LP-Gas Plant Code.

Informational Note No. 3: See 555.21 for motor fuel dispensing stations in marinas and boatyards.

Table 514.31(B)(1) Class 1 Locations — Motor Fuel Dispensing Facilities			
Location	Division (Group D)	Zone (Group IIA)	Extent of Classified Location ¹
Dispensing Device (except Overhead Type)^{2,3}			
Under dispenser containment	1	1	Entire space within and under dispenser pit or containment
Dispenser	2	2	Within 450 mm (18 in.) of dispenser enclosure or that portion of dispenser enclosure containing liquid handling components, extending horizontally in all directions and down to grade level
Outdoor	2	2	Up to 450 mm (18 in.) above grade level, extending 6 m (20 ft) horizontally in all directions from dispenser enclosure
Indoor			
- with mechanical ventilation	2	2	Up to 450 mm (18 in.) above floor level, extending 6 m (20 ft) horizontally in all directions from dispenser enclosure
- with gravity ventilation	2	2	Up to 450 mm (18 in.) above floor level, extending 7.5 m (25 ft) horizontally in all directions from dispenser enclosure
Dispensing Device — Overhead Type⁴			
	1	1	Space within dispenser enclosure and all electrical equipment integral with dispensing base or nozzle
	2	2	Within 450 mm (18 in.) of dispenser enclosure, extending horizontally in all directions and down to grade level
	2	2	Up to 450 mm (18 in.) above grade level, extending 6 m (20 ft) horizontally in all directions from a point vertically below edge of dispenser enclosure
Remote Pump —			
Outdoor	1	1	Entire space within any pit or box below grade level, any part of which is within 3 m (10 ft) horizontally from any edge of pump
	2	2	Within 900 mm (3 ft) of any edge of pump, extending horizontally in all directions
	2	2	Up to 450 mm (18 in.) above grade level, extending 3 m (10 ft) horizontally in all directions from any edge of pump
Indoor	1	1	Entire space within any pit
	2	2	Within 1.5 m (5 ft) of any edge of pump, extending in all directions
	2	2	Up to 900 mm (3 ft) above floor level, extending 7.5 m (25 ft) horizontally in all directions from any edge of pump
Sales, Storage, Rest Rooms including structures (such as the attendant's kiosk) on or adjacent to dispensers			
	unclassified	unclassified	Except as noted below
	1	1	Entire volume, if there is any opening to room within the extent of a Division 1 or Zone 1 location
	2	2	Entire volume, if there is any opening to room within the extent of a Division 2 or Zone 2 location
Tank, Aboveground			
Inside tank	1	0	Entire inside volume
Shell, ends, roof, dike area	1	1	Entire space within dike, where dike height exceeds distance from tank shell to inside of dike wall for more than 50 percent of tank circumference
	2	2	Entire space within dike, where dike height does not exceed distance from tank shell to inside of dike wall for more than 50 percent of tank circumference

Table 514.3(B)(1) <i>Continued</i>			
Location	Division (Group D)	Zone (Group IIA)	Extent of Classified Location ¹
Vent	2	2	Within 3 m (10 ft) of shell, ends, or roof of tank
	1	1	Within 1.5 m (5 ft) of open end of vent, extending in all directions
	2	2	Between 1.5 m and 3 m (5 ft and 10 ft) from open end of vent, extending in all directions
Tank, Underground			
Inside tank	1	0	Entire inside volume
Fill Opening	1	1	Entire space within any pit or box below grade level, any part of which is within a Division 1 or Division 2 classified location or within a Zone 1 or Zone 2 classified location
	2	2	Up to 450 mm (18 in.) above grade level, extending 1.5 m (5 ft) horizontally in all directions from any tight-fill connection and extending 3 m (10 ft) horizontally in all directions from any loose-fill connection
Vent	1	1	Within 1.5 m (5 ft) of open end of vent, extending in all directions
	2	2	Between 1.5 m and 3 m (5 ft and 10 ft) from open end of vent, extending in all directions
Vapor Processing System			
Pits	1	1	Entire space within any pit or box below grade level, any part of which: (1) is within a Division 1 or Division 2 classified location; (2) is within a Zone 1 or Zone 2 classified location; (3) houses any equipment used to transfer or process vapors
Equipment in protective enclosures	2	2	Entire space within enclosure
Equipment not within protective enclosure	2	2	Within 450 mm (18 in.) of equipment containing flammable vapors or liquid, extending horizontally in all directions and down to grade level
	2	2	Up to 450 mm (18 in.) above grade level within 3 m (10 ft) horizontally of the vapor processing equipment
- Equipment enclosure	1	1	Entire space within enclosure, if flammable vapor or liquid is present under normal operating conditions
	2	2	Entire space within enclosure, if flammable vapor or liquid is not present under normal operating conditions
- Vacuum assist blower	2	2	Within 450 mm (18 in.) of blower, extending horizontally in all directions and down to grade level
	2	2	Up to 450 mm (18 in.) above grade level, extending 3 m (10 ft) horizontally in all directions
Vault	1	1	Entire interior space, if Class I liquids are stored within

¹For marine application, *grade level* means the surface of a pier, extending down to water level.

²Refer to Figure 514.3 for an illustration of classified location around dispensing devices.

³Area classification inside the dispenser enclosure is covered in UL 87, *Standard for Power-Operated Dispensing Devices for Petroleum Products*.

⁴Ceiling-mounted hose reel. [30A: Table 8.3.1]

Dispensing Device	Extent of Classified Area	
	Class I, Division 1	Class I, Division 2
	Compressed natural gas	Entire space within the dispenser enclosure
Liquefied natural gas	Entire space within the dispenser enclosure and 1.5 m (5 ft) in all directions from the dispenser enclosure	From 1.5 m to 3.0 m (5 ft to 10 ft) in all directions from the dispenser enclosure
Liquefied petroleum gas	Entire space within the dispenser enclosure; 450 mm (18 in.) from the exterior surface of the dispenser enclosure to an elevation of 1.2 m (4 ft) above the base of the dispenser; the entire pit or open space beneath the dispenser and within 6.0 m (20 ft) horizontally from any edge of the dispenser when the pit or trench is not mechanically ventilated.	Up to 450 mm (18 in.) aboveground and within 6.0 m (20 ft) horizontally from any edge of the dispenser enclosure, including pits or trenches within this area when provided with adequate mechanical ventilation

[30A: Table 12.6.2]

NEC 2011

Please review this large table with your copy of NEC 2011

Figure 514.3 Classified Areas Adjacent to Dispensers as Detailed in Table 514.3(B)(1).

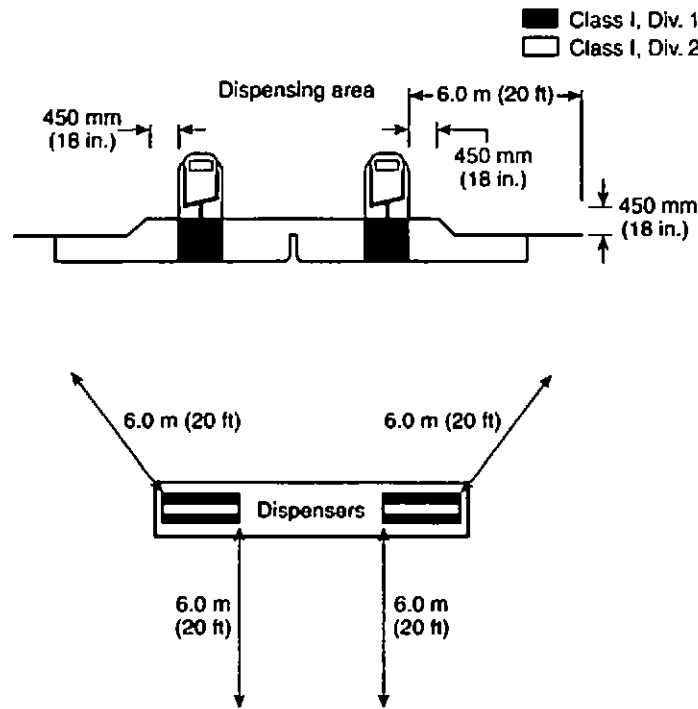

NEC 2011

30A:Figure 8.3.1

514.8 Underground Wiring

NEC Language

Underground wiring shall be installed in threaded rigid metal conduit or threaded steel intermediate metal conduit. Any portion of electrical wiring that is below the surface of a Class I, Division 1, or a Class I, Division 2, location [as classified in Table 514.3(B)(1) and Table 514.3(B)(2)] shall be sealed within 3.05 m (10 ft) of the point of emergence above grade. Except for listed explosionproof reducers at the conduit seal, there shall be no union, coupling, box, or fitting between the conduit seal and the point of emergence above grade. Refer to **Table 300.5** in the NEC 2011.

Exception No. 1: Type MI cable shall be permitted where it is installed in accordance with Article 332.

Changed From NEC 2008

514.8 Exception 2: This was revised to specify Types PVC and RTRC rigid nonmetallic conduits.

NEC Language

Exception No. 2: Type PVC conduit and Type RTRC conduit shall be permitted where buried under not less than 600 mm (2 ft) of cover. Where Type PVC conduit or Type RTRC conduit is used, threaded rigid metal conduit or threaded steel intermediate metal conduit shall be used for the last 600 mm (2 ft) of the underground run to emergence or to the point of connection to the aboveground raceway, and an equipment grounding conductor shall be included to provide electrical continuity of the raceway system and for grounding of non-current-carrying metal parts.

514.11 Circuit Disconnects

Changed From NEC 2008

514.11: This was revised to identify all of the types of circuits that are required to be disconnected and to change “acceptable” to “approved” in regard to other types of disconnecting means.

Highlight

Fuel dispensing equipment has become increasingly complex over the past several years.

Pull up to any gas station and you will notice that the pumps are outfitted not only with supply power, but they are sometimes equipped with credit card readers, video cameras, television monitors, and sometimes interactive computer ordering systems.

These additional circuits can contain the potential to create an explosion or electrical shock hazard in the event of a fault or fuel spill.

The revision to 514.11(A) will now require that all of these circuits to be simultaneously disconnected with the action of its emergency disconnecting means.

NEC Language

(A) **General.** Each circuit leading to or through dispensing equipment, including all associated power, communications, data, and video circuits, and equipment for remote pumping systems, shall be provided with a clearly identified and readily accessible switch or other approved means, located remote from the dispensing devices, to disconnect simultaneously from the source of supply, all conductors of the circuits, including the grounded conductor, if any.

Single-pole breakers utilizing handle ties shall not be permitted.

514.13 Provisions for Maintenance and Service of Dispensing Equipment***Changed From NEC 2008***

514.13: This was revised to identify all of the types of circuits that are required to be disconnected.

NEC Language

Each dispensing device shall be provided with a means to remove all external voltage sources, including power, communications, data, and video circuits and including feedback, during periods of maintenance and service of the dispensing equipment. The location of this means shall be permitted to be other than inside or adjacent to the dispensing device. The means shall be capable of being locked in the open position.

ARTICLE 515 — Bulk Storage Plants

This article covers a property or portion of a property where flammable liquids are received by tank vessel, pipelines, tank car, or tank vehicle and are stored or blended in bulk for the purpose of distributing such liquids by tank vessel, pipeline, tank car, tank vehicle, portable tank, or container.

Article 515 covers facilities that store (in bulk) and distribute flammable liquids as opposed to dispensing liquids into fuel tanks of vehicles. Flammable liquid dispensing locations, including those within the bulk storage facility, are covered under Article 514.

Bulk storage tanks may be located inside buildings or outside either above ground or underground. Addressed by this article are the hazardous locations in the vicinity of the storage tank, and the tank vehicle, pier, or wharf from which the liquids are loaded and offloaded. This article also covers the classification of the areas around drum storage containers.

515.7 Wiring and Equipment Above Class I Locations***Changed From NEC 2008***

515.7(A) **Fixed Wiring:** This was revised to include PLTC, PLTC-ER, ITC, and ITC-ER cables and to require cable terminate in listed fittings.

NEC Language

(A) **Fixed Wiring.** All fixed wiring above Class I locations shall be in metal raceways, Schedule 80 PVC conduit, Type RTRC marked with the suffix -XW, or Type MI, Type TC, or Type MC cable, or Type PLTC and Type PLTC-ER cable in accordance with the provisions of Article 725, including installation in cable tray systems or Type ITC and Type ITC-ER cable as permitted in 727.4. The cable shall be terminated with listed fittings.

515.8 Underground Wiring**Changed From NEC 2008**

515.8(A) Wiring Method: This was revised to specify Types PVC and RTRC rigid nonmetallic conduits.

NEC Language

(A) **Wiring Method.** Underground wiring shall be installed in threaded rigid metal conduit or threaded steel intermediate metal conduit or, where buried under not less than 600 mm (2 ft) of cover, shall be permitted in Type PVC conduit, Type RTRC conduit, or a listed cable. Where Type PVC conduit or Type RTRC conduit is used, threaded rigid metal conduit or threaded steel intermediate metal conduit shall be used for not less than the last 600 mm (2 ft) of the conduit run to the conduit point of emergence from the underground location or to the point of connection to an aboveground raceway. Where cable is used, it shall be enclosed in threaded rigid metal conduit or threaded steel intermediate metal conduit from the point of lowest buried cable level to the point of connection to the aboveground raceway.

(B) **Insulation.** Conductor insulation shall comply with 501.20.

Changed From NEC 2008

515.8(C) Nonmetallic Wiring: This was revised to specify Types PVC and RTRC rigid nonmetallic conduits.
--

NEC Language

(C) **Nonmetallic Wiring.** Where Type PVC conduit, Type RTRC conduit, or cable with a nonmetallic sheath is used, an equipment grounding conductor shall be included to provide for electrical continuity of the raceway system and for grounding of non-current-carrying metal parts.

Article 516 — Spray Application, Dipping, and Coating Processes

Article 516 covers the regular or frequent application of flammable liquids, combustible liquids, and combustible powders by spray operations and the application of flammable liquids, or combustible liquids at temperatures above their flashpoint, by dipping, coating, or other means.

The proper maintenance and operation of processes and process areas where flammable and combustible materials are handled and applied are critical with respect to the protection of life and property from fire or explosion. An analysis of actual experience in industry demonstrates that the largest fire losses and frequency of fires have occurred where the proper codes and standards have not been used or applied properly.

The safety of life and property from fire or explosion as a result of spray applications of flammable and combustible materials, such as paints, finishes, and adhesives, depends on the arrangement and operation of a particular installation. The principal hazards of spray application operations originate from flammable or combustible liquids or powders and their vapors or mists, as well as from highly combustible residues or powders. The human element necessitates careful consideration of the operation's location and the installation of extinguishing equipment to reduce the possibility of fire spreading to other property and to minimize the probability of damage to other property.

516.4 Wiring and Equipment in Class I Locations

NEC Language

(D) **Portable Equipment.** Portable electric luminaires or other utilization equipment shall not be used in a spray area during spray operations.

Exception No. 1: Where portable electric luminaires are required for operations in spaces not readily illuminated by fixed lighting within the spraying area, they shall be of the type identified for Class I, Division 1 or Class 1, Zone 1 locations where readily ignitable residues may be present. [33:6.9 Exception]

Changed From NEC 2008

516.4(D) Exception 2: This was revised to apply to spray booths in addition to those used for "automobile refinishing."

NEC Language

Exception No. 2: Where portable electric drying apparatus is used in spray booths and the following requirements are met:

- (a) The apparatus and its electrical connections are not located within the spray enclosure during spray operations.
- (b) Electrical equipment within 450 mm (18 in.) of the floor is identified for Class I, Division 2 or Class I, Zone 2 locations.
- (c) All metallic parts of the drying apparatus are electrically bonded and grounded.

(d) Interlocks are provided to prevent the operation of spray equipment while drying apparatus is within the spray enclosure, to allow for a 3-minute purge of the enclosure before energizing the drying apparatus and to shut off drying apparatus on failure of ventilation system.

516.7 Wiring and Equipment Not Within Class I and II Locations

Changed From NEC 2008

516.7(A) Wiring: This was revised to specify Types PVC and RTRC rigid nonmetallic conduits.

NEC Language

(A) **Wiring.** All fixed wiring above the Class I and II locations shall be in metal raceways, Type PVC conduit, Type RTRC conduit, or electrical nonmetallic tubing; where cables are used, they shall be Type MI, Type TC, or Type MC cable. Cellular metal floor raceways shall only be permitted to supply ceiling outlets or as extensions to the area below the floor of a Class I or II location. Where cellular metal raceways, are used, they shall not have connections leading into or passing through the Class I or II location unless suitable seals are provided.

Article 517 — Health Care Facilities

Health care facilities differ from other types of building in many important respects.

Article 517 is primarily concerned with those parts of health care facilities where patients are examined and treated.

Such facilities, whether permanent or movable, still fall under this article. However, Article 517 wiring and protection requirements do not apply to business offices, patient sleeping areas, or waiting rooms, nor does it apply to animal veterinary facilities.

I. General

517.2 Definitions

NEC Language

All definitions in this section are provided to help retain context.

Alternate Power Source. One or more generator sets, or battery systems where permitted, intended to provide power during the interruption of the normal electrical services or the public utility electrical service intended to provide power during interruption of service normally provided by the generating facilities on the premises.

Ambulatory Health Care Occupancy. A building or portion thereof used to provide services or treatment simultaneously to four or more patients that provides, on an outpatient basis, one or more of the following:

- (1) Treatment for patients that renders the patients incapable of taking action for self-preservation under emergency conditions without assistance of others.
- (2) Anesthesia that renders the patients incapable of taking action for self-preservation under emergency conditions without the assistance of others.
- (3) Emergency or urgent care for patients who, due to the nature of their injury or illness, are incapable of taking action for self-preservation under emergency conditions without the assistance of others. [101:3.3.168.1]

Anesthetizing Location. Any area of a facility that has been designated to be used for the administration of any flammable or nonflammable inhalation anesthetic agent in the course of examination or treatment, including the use of such agents for relative analgesia.

Changed From NEC 2008

517.2. Battery-Powered Lighting Units: The NEC added a new definition to correlate with use of term in several Article 517 requirements.

NEC Language

Battery-Powered Lighting Units. Individual unit equipment for backup illumination consisting of the following:

- (1) Rechargeable battery
- (2) Battery-charging means
- (3) Provisions for one or more lamps mounted on the equipment, or with terminals for remote lamps, or both
- (4) Relaying device arranged to energize the lamps automatically upon failure of the supply to the unit equipment

Critical Branch. A subsystem of the emergency system consisting of feeders and branch circuits supplying energy to task illumination, special power circuits, and selected receptacles serving areas and functions related to patient care and that are connected to alternate power sources by one or more transfer switches during interruption of normal power source. [99:3.3.26]

Electrical Life-Support Equipment. Electrically powered equipment whose continuous operation is necessary to maintain a patient's life. [99:3.3.37]

Emergency System. A system of circuits and equipment intended to supply alternate power to a limited number of prescribed functions vital to the protection of life and safety. [99:3.3.41]

Equipment System. A system of circuits and equipment arranged for delayed, automatic, or manual connection to the alternate power source and that serves primarily 3-phase power equipment.

Essential Electrical System. A system comprised of alternate sources of power and all connected distribution systems and ancillary equipment, designed to

ensure continuity of electrical power to designated areas and functions of a health care facility during disruption of normal power sources, and also to minimize disruption within the internal wiring system. [99:3.3.44]

Exposed Conductive Surfaces. Those surfaces that are capable of carrying electric current and that are unprotected, unenclosed, or unguarded, permitting personal contact. Paint, anodizing, and similar coatings are not considered suitable insulation, unless they are listed for such use.

Fault Hazard Current. The hazard current of a given isolated system with all devices connected except the line isolation monitor.

Flammable Anesthetics. Gases or vapors, such as fluroxene, cyclopropane, divinyl ether, ethyl chloride, ethyl ether, and ethylene, which may form flammable or explosive mixtures with air, oxygen, or reducing gases such as nitrous oxide.

Flammable Anesthetizing Location. Any area of the facility that has been designated to be used for the administration of any flammable inhalation anesthetic agents in the normal course of examination or treatment.

Hazard Current. For a given set of connections in an isolated power system, the total current that would flow through a low impedance if it were connected between either isolated conductor and ground.

Monitor Hazard Current. The hazard current of the line isolation monitor alone.

Total Hazard Current. The hazard current of a given isolated system with all devices, including the line isolation monitor, connected.

Health Care Facilities. Buildings or portions of buildings in which medical, dental, psychiatric, nursing, obstetrical, or surgical care are provided. Health care facilities include, but are not limited to, hospitals, nursing homes, limited care facilities, clinics, medical and dental offices, and ambulatory care centers, whether permanent or movable.

Hospital. A building or portion thereof used on a 24-hour basis for the medical, psychiatric, obstetrical, or surgical care of four or more inpatients. [101:3.3.124]

Isolated Power System. A system comprising an isolating transformer or its equivalent, a line isolation monitor, and its ungrounded circuit conductors.

Changed From NEC 2008

517.2. Isolation Transformer: Revised definition to clarify connection between primary and secondary windings.

NEC Language

Isolation Transformer. A transformer of the multiple-winding type, with the primary and secondary windings physically separated, which inductively couples its secondary winding(s) to circuit conductors connected to its primary winding(s).

II. Wiring and Protection

517.13 Grounding of Receptacles and Fixed Electrical Equipment in Patient Care Areas

NEC Language

Wiring in patient care areas shall comply with 517.13(A) and (B).

(A) **Wiring Methods.** All branch circuits serving patient care areas shall be provided with an effective ground-fault current path by installation in a metal raceway system, or a cable having a metallic armor or sheath assembly. The metal raceway system, or metallic cable armor, or sheath assembly shall itself qualify as an equipment grounding conductor in accordance with 250.118.

(B) **Insulated Equipment Grounding Conductor.**

Changed From NEC 2008

517.13(B)(1) **General:** This was revised to identify items that are required to be connected to the insulated equipment grounding conductor.

NEC Language

(1) **General.** The following shall be directly connected to an insulated copper equipment grounding conductor that is installed with the branch circuit conductors in the wiring methods as provided in 517.13(A).

- (1) The grounding terminals of all receptacles.
- (2) Metal boxes and enclosures containing receptacles.
- (3) All non-current-carrying conductive surfaces of fixed electrical equipment likely to become energized that are subject to personal contact, operating at over 100 volts.

Changed From NEC 2008

517.13(B)(1) **Exception:** The NEC added a new exception recognizing use of an insulated equipment bonding jumper as a means to connect a metal box and receptacle grounding terminal to the equipment grounding conductor.

NEC Language

Exception: An insulated equipment bonding jumper that directly connects to the equipment grounding conductor is permitted to connect the box and receptacle(s) to the equipment grounding conductor.

Changed From NEC 2008

517.13(B)(2) **Sizing:** Relocated and revised requirement for sizing equipment grounding conductors and equipment bonding jumpers.

NEC Language

(2) **Sizing.** Equipment grounding conductors and equipment bonding jumpers shall be sized in accordance with 250.122.

517.16 Receptacles with Insulated Grounding Terminals

Changed From NEC 2008

517.16: Revised requirement to prohibit use of receptacles with insulated grounding terminal in patient care areas.

NEC Language

Receptacles with insulated grounding terminals, as described in 250.146(D), shall not be permitted.

517.17 Ground-Fault Protection

Changed From NEC 2008

517.17: This was revised to clarify additional levels of ground-fault protection are not permitted to be installed on the load side of any essential electrical system transfer switch.

NEC Language

(A) **Applicability.** The requirements of 517.17 shall apply to hospitals and other buildings (including multiple-occupancy buildings) with critical care areas or utilizing electrical life-support equipment, and buildings that provide the required essential utilities or services for the operation of critical care areas or electrical life-support equipment.

(B) **Feeders.** Where ground-fault protection is provided for operation of the service disconnecting means or feeder disconnecting means as specified by 230.95 or 215.10, an additional step of ground-fault protection shall be provided in all next level feeder disconnecting means downstream toward the load. Such protection shall consist of overcurrent devices and current transformers or other equivalent protective equipment that shall cause the feeder disconnecting means to open.

The additional levels of ground-fault protection shall not be installed ~~as follows~~ (4) on the load side of an essential electrical system transfer switch.

Changed From NEC 2008

517.17(C) **Selectivity:** Revised requirement on selectivity between service and feeder ground-fault protective devices.

NEC Language

(C) **Selectivity.** Ground-fault protection for operation of the service and feeder disconnecting means shall be fully selective such that the feeder device, but not the service device, shall open on ground faults on the load side of the feeder device. Separation of ground-fault protection time-current characteristics shall conform to manufacturer's recommendations and shall consider all required tolerances and disconnect operating time to achieve 100 percent selectivity.

Informational Note: See 230.95, fine print note, for transfer of alternate source where ground-fault protection is applied.

517.18 General Care Areas

Changed From NEC 2008

517.18(A) Patient Bed Location: This was revised to prohibit use of multiwire branch circuits from supplying receptacles at patient bed locations.

NEC Language

(A) Patient Bed Location. Each patient bed location shall be supplied by at least two branch circuits, one from the emergency system and one from the normal system. All branch circuits from the normal system shall originate in the same panelboard.

The branch circuit serving patient bed locations shall not be part of a multi-wire branch circuit.

Exception No. 1: Branch circuits serving only special-purpose outlets or receptacles, such as portable X-ray outlets, shall not be required to be served from the same distribution panel or panels.

Exception No. 2: Requirements of 517.18(A) shall not apply to patient bed locations in clinics, medical and dental offices, and outpatient facilities; psychiatric, substance abuse, and rehabilitation hospitals; sleeping rooms of nursing homes and limited care facilities meeting the requirements of 517.10(B)(2).

Exception No. 3: A general care patient bed location served from two separate transfer switches on the emergency system shall not be required to have circuits from the normal system.

Changed From NEC 2008

517.18(B) Patient Bed Location Receptacles: This was revised to permit “quadruplex” type receptacles.

NEC Language

(B) Patient Bed Location Receptacles. Each patient bed location shall be provided with a minimum of four receptacles. They shall be permitted to be of the single, duplex, or quadruplex type, or any combination of the three. All receptacles, whether four or more, shall be listed “hospital grade” and so identified. The grounding terminal of each receptacle shall be connected to an insulated copper equipment grounding conductor sized in accordance with Table 250.122.

Exception No. 1: The requirements of 517.18(B) shall not apply to psychiatric, substance abuse, and rehabilitation hospitals meeting the requirements of 517.10(B)(2).

Exception No. 2: Psychiatric security rooms shall not be required to have receptacle outlets installed in the room.

Informational Note. It is not intended that there be a total, immediate replacement of existing non-hospital grade receptacles. It is intended, however, that non-hospital grade receptacles be replaced with hospital grade receptacles upon modification of use, renovation, or as existing receptacles need replacement.

517.19 Critical Care Areas

Changed From NEC 2008

517.19(A) **Patient Bed Location Branch Circuits:** This was revised to prohibit use of multiwire branch circuits from supplying receptacles at patient bed locations.

NEC Language

(A) **Patient Bed Location Branch Circuits.** Each patient bed location shall be supplied by at least two branch circuits, one or more from the emergency system and one or more circuits from the normal system. At least one branch circuit from the emergency system shall supply an outlet(s) only at that bed location. All branch circuits from the normal system shall be from a single panelboard. Emergency system receptacles shall be identified and shall also indicate the panelboard and circuit number supplying them.

The branch circuit serving patient bed locations shall not be part of a multi-wire branch circuit.

Exception No. 1: Branch circuits serving only special-purpose receptacles or equipment in critical care areas shall be permitted to be served by other panelboards.

Exception No. 2: Critical care locations served from two separate transfer switches on the emergency system shall not be required to have circuits from the normal system.

(B) **Patient Bed Location Receptacles.**

(1) **Minimum Number and Supply.** Each patient bed location shall be provided with a minimum of six receptacles, at least one of which shall be connected to either of the following:

- (1) The normal system branch circuit required in 517.19(A)
- (2) An emergency system circuit supplied by a different transfer switch than the other receptacles at the same patient bed location

Changed From NEC 2008

517.19(B)(2) **Receptacle Requirements:** This was revised to permit “quadruplex” type receptacles.

NEC Language

(2) **Receptacle Requirements.** The receptacles required in 517.19(B)(1) shall be permitted to be single, duplex, or quadruplex type or any combination thereof. All receptacles shall be listed “hospital grade” and shall be so identified. The grounding terminal of each receptacle shall be connected to the reference grounding point by means of an insulated copper equipment grounding conductor.

Changed From NEC 2008

517.19(D) Equipment Grounding and Bonding: This was revised to clarify that the requirement covers any metal equipment or equipment enclosure that is connected to a metal raceway or metal cable containing feeder conductors.

NEC Language

(D) Equipment Grounding and Bonding. Where a grounded electrical distribution system is used and metal feeder raceway or Type MC or MI cable that qualifies as an equipment grounding conductor in accordance with 250.118 is installed, grounding of enclosures and equipment, such as panelboards and switchboards, shall be ensured by one of the following bonding means at each termination or junction point of the metal raceway or Type MC or MI cable:

517.20 Wet Procedure Locations**Changed From NEC 2008**

517.20(A) Receptacles and Fixed Equipment: This was revised to specify performance requirements for two means of controlling shock exposure in wet procedure locations.

NEC Language

(A) Receptacles and Fixed Equipment. Wet procedure location patient care areas shall be provided with special protection against electric shock by one of the following means:

- (1) Power distribution system that inherently limits the possible ground-fault current due to a first fault to a low value, without interrupting the power supply
- (2) Power distribution system in which the power supply is interrupted if the ground-fault current does, in fact, exceed a value of 6 mA

Changed From NEC 2008

517.20(A) Exception: This was revised to clarify that equipment grounding conductor is to be insulated.

NEC Language

Exception: Branch circuits supplying only listed, fixed, therapeutic and diagnostic equipment shall be permitted to be supplied from a grounded service, single- or 3-phase system, provided that

- (a) Wiring for grounded and isolated circuits does not occupy the same raceway, and
- (b) All conductive surfaces of the equipment are connected to an insulated copper equipment grounding conductor.

III. Essential Electrical System

517.26 Application of Other Articles

NEC Language

The essential electrical system shall meet the requirements of Article 700, except as amended by Article 517.

Changed From NEC 2008

517.26 Informational Note: The NEC added a new informational note referencing NFPA 110 for design and installation of essential electrical systems.

NEC Language

Informational Note: The provisions of NFPA 110-2010, Standard for Emergency and Standby Power Systems, should be considered when designing and installing essential electrical power supply systems.

517.30 Essential Electrical Systems for Hospitals

(C) Wiring Requirements.

Changed From NEC 2008

517.30(C)(1) Separation from Other Circuits: This was revised to specify separate systems where multiple emergency system transfer switches are used to supply general care or critical care locations.

NEC Language

(1) **Separation from Other Circuits.** The life safety branch and critical branch of the emergency system shall be kept entirely independent of all other wiring and equipment and shall not enter the same raceways, boxes, or cabinets with each other or other wiring.

Where general care locations are served from two separate transfer switches on the emergency system in accordance with 517.18(A), Exception No. 3, the general care circuits from the two separate systems shall be kept independent of each other.

Where critical care locations are served from two separate transfer switches on the emergency system in accordance with 517.19(A), Exception No. 2, the critical care circuits from the two separate systems shall be kept independent of each other.

Wiring of the life safety branch and the critical branch shall be permitted to occupy the same raceways, boxes, or cabinets of other circuits not part of the branch where such wiring complies with one of the following:

- (1) Is in transfer equipment enclosures
- (2) Is in exit or emergency luminaires supplied from two sources
- (3) Is in a common junction box attached to exit or emergency luminaires supplied from two sources

Changed From NEC 2008

517.30(C)(1)(4): This was revised to permit combining of circuits only where supplied from the same branch of emergency system and the same transfer switch.

NEC Language

(4) Is for two or more emergency circuits supplied from the same branch and same transfer switch.

The wiring of the equipment system shall be permitted to occupy the same raceways, boxes, or cabinets of other circuits that are not part of the emergency system.

IV. Inhalation Anesthetizing Locations**517.63 Grounded Power Systems in Anesthetizing Locations****Changed From NEC 2008**

517.63(A) **Battery-Powered Lighting Units:** This was revised to clarify use and to permit connection to a lighting circuit supplied from the critical branch.

NEC Language

(A) **Battery-Powered Lighting Units.** One or more battery-powered lighting units shall be provided and shall be permitted to be wired to the critical lighting circuit in the area and connected ahead of any local switches.

Changed From NEC 2008

517.63(E) **Location of Isolated Power Systems:** This was revised to clarify requirement applies to isolated power system equipment and the circuit supplying that equipment.

NEC Language

(E) **Location of Isolated Power Systems.** Where an isolated power system is utilized, the isolated power equipment shall be listed as isolated power equipment. Isolated power system equipment and its supply circuit shall be permitted to be located in an anesthetizing location, provided it is installed above a hazardous (classified) location or in an other-than-hazardous (classified) location.

VI. Communications, Signaling Systems, Data Systems, Fire Alarm Systems, and Systems Less Than 120 Volts, Nominal**517.80 Patient Care Areas****Changed From NEC 2008**

517.80: This was revised to clarify grounding and mechanical protection requirements for Class 2 and Class 3 signaling and communications systems and to power-limited fire alarm systems.

NEC Language

Equivalent insulation and isolation to that required for the electrical distribution systems in patient care areas shall be provided for communications, signaling systems, data system circuits, fire alarm systems, and systems less than 120 volts, nominal.

Class 2 and Class 3 signaling and communications systems and power-limited fire alarm systems shall not be required to comply with the grounding requirements of 517.13, to comply with the mechanical protection requirements of 517.30(C)(3)(5), or to be enclosed in raceways, unless otherwise specified by Chapter 7 or 8.

Secondary circuits of transformer-powered communications or signaling systems shall not be required to be enclosed in raceways unless otherwise specified by Chapter 7 or 8. [99:4.4.2.2.4.6]

VII. Isolated Power Systems**517.160 Isolated Power Systems****(A) Installations.*****Changed From NEC 2008***

517.160(A)(1) **Isolated Power Circuits:** This was revised to include circuit breakers as a means of control and to require separation of isolated power systems conductors from conductors of other systems.

NEC Language

(1) **Isolated Power Circuits.** Each isolated power circuit shall be controlled by a switch or circuit breaker that has a disconnecting pole in each isolated circuit conductor to simultaneously disconnect all power. Such isolation shall be accomplished by means of one or more isolation transformers, by means of generator sets, or by means of electrically isolated batteries. Conductors of isolated power circuits shall not be installed in cables, raceways, or other enclosures containing conductors of another system.

Changed From NEC 2008

517.160(A)(5) **Conductor Identification:** This was revised to specify conductor identification applies to the entire length of the conductor.

Highlight

Isolated power systems are used to supply critical systems or equipment that requires clean power.

These systems are most often found in hospitals, laboratories, IT data centers, etc.

In the 2008 Code, the conductors of these systems were allowed to be identified at the ends by marking tape or some other means at the time of installation. This is no longer acceptable.

Newly installed conductors supplying isolated systems will now be required to be color coded along its entire length. Furthermore, the colors to be used are specifically orange for the first conductor and brown for the second. Each conductor must also contain a distinctive colored stripe other than white, green, or gray along its entire length. For three phase systems, the third conductor must be yellow in color with a distinctive stripe along its entire length. This provision by its nature will eliminate the use of tape to mark conductors of isolated systems.

NEC Language

(5) **Conductor Identification.** The isolated circuit conductors shall be identified as follows:

(1) **Isolated Conductor No. 1** — Orange with at least one distinctive colored stripe other than white, green, or gray along the entire length of the conductor

(2) **Isolated Conductor No. 2** — Brown with at least one distinctive colored stripe other than white, green, or gray along the entire length of the conductor

For 3-phase systems, the third conductor shall be identified as yellow with at least one distinctive colored stripe other than white, green, or gray along the entire length of the conductor. Where isolated circuit conductors supply 125-volt, single-phase, 15- and 20-ampere receptacles, the striped orange conductor(s) shall be connected to the terminal(s) on the receptacles that are identified in accordance with 200.10(B) for connection to the grounded circuit conductor.

ARTICLE 518 — Assembly Occupancies

This article applies to buildings or portions of a building that are specifically designed or intended for the assembly of 100 or more people.

Article 518 recognizes that it is much harder to evacuate 100 or more people from a burning building than to evacuate just a few people.

518.3 Other Articles

(A) **Hazardous (Classified) Areas.** Electrical installations in hazardous (classified) areas located in assembly occupancies shall comply with Article 500.

Changed From NEC 2008

518.3(B) Temporary Wiring: This was revised to specify type of GFCI protection required for branch circuits and feeders supplied through cord and plug connections and to require compliance with GFCI requirements contained in the NEC other than 590.6.

NEC Language

(B) **Temporary Wiring.** In exhibition halls used for display booths, as in trade shows, the temporary wiring shall be permitted to be installed in accordance with Article 590. Flexible cables and cords approved for hard or extra-hard usage shall be permitted to be laid on floors where protected from contact by the general public. The ground-fault circuit-interrupter requirements of 590.6 shall not apply. All other ground-fault circuit-interrupter requirements of this Code shall apply.

Where ground-fault circuit interrupter protection for personnel is supplied by plug-and-cord-connection to the branch circuit or to the feeder, the ground fault circuit interrupter protection shall be listed as portable ground fault circuit interrupter protection or provide a level of protection equivalent to a portable ground fault circuit interrupter, whether assembled in the field or at the factory.

Exception: Where conditions of supervision and maintenance ensure that only qualified persons will service the installation, flexible cords or cables identified in Table 400.4 for hard usage or extra-hard usage shall be permitted in cable trays used only for temporary wiring. All cords or cables shall be installed in a single layer. A permanent sign shall be attached to the cable tray at intervals not to exceed 7.5 m (25 ft). The sign shall read

CABLE TRAY FOR TEMPORARY WIRING ONLY

518.5 Supply

Changed From NEC 2008

518.5: This was revised to replace "derating" with "ampacity adjustment".

NEC Language

Portable switchboards and portable power distribution equipment shall be supplied only from listed power outlets of sufficient voltage and ampere rating. Such power outlets shall be protected by overcurrent devices. Such overcurrent devices and power outlets shall not be accessible to the general public. Provisions for connection of an equipment grounding conductor shall be provided. The neutral conductor of feeders supplying solid-state phase control, 3-phase, 4-wire dimmer systems shall be considered a current-carrying conductor for purposes of ampacity adjustment. The neutral conductor of feeders supplying solid-state sine wave, 3-phase, 4-wire dimming systems shall not be considered a current-carrying conductor for purposes of ampacity adjustment.

Exception: The neutral conductor of feeders supplying systems that use or may use both phase-control and sine-wave dimmers shall be considered as current-carrying for purposes of ampacity adjustment.

Informational Note: For definitions of solid-state dimmer types, see 520.2.

ARTICLE 520 — Theaters, Audience Areas of Motion Picture and Television Studios, Performance Areas, and Similar Locations

Article 520 covers all buildings or that part of a building or structure, indoor or outdoor, designed or used for presentation, dramatic, musical, motion picture projection, or similar purposes and to specific audience seating areas within motion picture or television studios.

The special requirements of Article 520 apply only to that part of a building used as a theater or for a similar purpose and do not necessarily apply to the entire building. In a school building, for example, the requirements of Article 520 apply to an auditorium used for dramatic or other performances.

The special requirements of this article apply to the stage, auditorium, dressing rooms, and main corridors leading to the auditorium, but not to other parts of the building that are not involved in the use of the auditorium for performances or entertainment. The theater space may be a traditional theater, where the audience sits in the auditorium (house) facing the proscenium arch and views the performance on the stage on the other side of the arch, or it may house other spaces, such as a simple stage platform, either indoors or outdoors, with seats on three or four sides facing the platform. Audience areas of motion picture and television studios, as defined and covered in Article 530, are also covered by the requirements of Article 520.

I. General

520.6 Number of Conductors in Raceway

Changed From NEC 2008

520.6: This was revised to clarify "drop boxes" and "connector strips" are stage circuits and are covered by this requirement.

NEC Language

The number of conductors permitted in any metal conduit, rigid nonmetallic conduit as permitted in this article, or electrical metallic tubing for circuits or for remote-control conductors shall not exceed the percentage fill shown in Table 1 of Chapter 9. Where contained within an auxiliary gutter or a wireway, the sum of the cross-sectional areas of all contained conductors at any cross section shall not exceed 20 percent of the interior cross-sectional area of the auxiliary gutter or wireway. The 30-conductor limitation of 366.22 and 376.22 shall not apply.

520.10 Portable Equipment Used Outdoors

Changed From NEC 2008

520.10: This was revised to clarify that the requirement applies to portable equipment used outdoors and the condition under which equipment not identified for outdoor use may be used.

NEC Language

Portable stage and studio lighting equipment and portable power distribution equipment not identified for outdoor use shall be permitted for temporary use outdoors, provided the equipment is supervised by qualified personnel while energized and barriered from the general public.

II. Fixed Stage Switchboards

520.27 Stage Switchboard Feeders

NEC Language

(A) Type of Feeder. Feeders supplying stage switchboards shall be one of the types in 520.27(A)(1) through (A)(3).

- (1) **Single Feeder.** A single feeder disconnected by a single disconnect device.
- (2) **Multiple Feeders to Intermediate Stage Switchboard (Patch Panel).** Multiple feeders of unlimited quantity shall be permitted, provided that all multiple feeders are part of a single system. Where combined, neutral conductors in a given raceway shall be of sufficient ampacity to carry the maximum unbalanced current supplied by multiple feeder conductors in the same raceway, but they need not be greater than the ampacity of the neutral conductor supplying the primary stage switchboard. Parallel neutral conductors shall comply with 310.10(H).
- (3) **Separate Feeders to Single Primary Stage Switchboard (Dimmer Bank).** Installations with separate feeders to a single primary stage switchboard shall have a disconnecting means for each feeder. The primary stage switchboard shall have a permanent and obvious label stating the number and location of disconnecting means. If the disconnecting means are located in more than one distribution switchboard, the primary stage switchboard shall be provided with barriers to correspond with these multiple locations.

Changed From NEC 2008

520.27(B) **Neutral Conductor:** This was revised to replace "derating" with "ampacity adjustment."

NEC Language

(B) **Neutral Conductor.** For the purpose of ampacity adjustment, the following shall apply:

- (1) The neutral conductor of feeders supplying solid-state, phase-control 3-phase, 4-wire dimming systems shall be considered a current-carrying conductor.
- (2) The neutral conductor of feeders supplying solid-state, sine wave 3-phase, 4-wire dimming systems shall not be considered a current-carrying conductor.
- (3) The neutral conductor of feeders supplying systems that use or may use both phase-control and sine wave dimmers shall be considered as current-carrying.

III. Fixed Stage Equipment Other Than Switchboards

520.44 Borders, Proscenium Sidelights, Drop Boxes, and Connector Strips

Changed From NEC 2008

520.44: This was revised to include "drop boxes" and "connector strips" and to add a requirement for identification of conductors in multi-conductor extra-hard usage cord and cable.

NEC Language

(A) **General.** Borders and proscenium sidelights shall be as follows:

- (1) Constructed as specified in 520.43
- (2) Suitably stayed and supported
- (3) Designed so that the flanges of the reflectors or other adequate guards protect the lamps from mechanical damage and from accidental contact with scenery or other combustible material

(B) **Connector Strips and Drop Boxes.** Connector strips and drop boxes shall be as follows:

- (1) Suitably stayed and supported
- (2) Listed as stage and studio wiring devices

(C) **Cords and Cables for Border Lights, Drop Boxes, and Connector Strips.**

(1) **General.** Cords and cables for supply to border lights, drop boxes, and connector strips shall be listed for extra-hard usage. The cords and cables shall be suitably supported. Such cords and cables shall be employed only where flexible conductors are necessary. Ampacity of the conductors shall be as provided in 400.5.

(2) **Cords and Cables Not in Contact with Heat-Producing Equipment.** Listed multiconductor extra-hard-usage-type cords and cables not in direct contact with equipment containing heat-producing elements shall be permitted to have their ampacity determined by Table 520.44. Maximum load current in any conductor with an ampacity determined by Table 520.44 shall not exceed the values in Table 520.44.

Table 520.44 Ampacity of Listed Extra-Hard-Usage Cords and Cables with Temperature Ratings of 75°C (167°F) and 90°C (194°F)* [Based on Ambient Temperature of 30°C (86°F)]

Size (AWG)	Temperature Rating of Cords and Cables		Maximum Rating of Overcurrent Device
	75°C (167°F)	90°C (194°F)	
14	24	28	15
12	32	35	20
10	41	47	25
8	57	65	35
6	77	87	45
4	101	114	60
2	133	152	80

*Ampacity shown is the ampacity for multiconductor cords and cables where only three copper conductors are current-carrying as described in 400.5. If the number of current-carrying conductors in a cord or cable exceeds three and the load diversity factor is a minimum of 50 percent, the ampacity of each conductor shall be reduced as shown in the following table:

Number of Conductors	Percent of Ampacity
4-6	80
7-24	70
25-42	60
43 and above	50

Note: Ultimate insulation temperature. In no case shall conductors be associated together in such a way with respect to the kind of circuit, the wiring method used, or the number of conductors such that the temperature limit of the conductors is exceeded.

A neutral conductor that carries only the unbalanced current from other conductors of the same circuit need not be considered as a current-carrying conductor.

In a 3-wire circuit consisting of two phase conductors and the neutral conductor of a 4-wire, 3-phase, wye-connected system, the neutral conductor carries approximately the same current as the line-to-neutral currents of the other conductors and shall be considered to be a current-carrying conductor.

On a 4-wire, 3-phase wye circuit where the major portion of the load consists of nonlinear loads, there are harmonic currents in the neutral conductor. Therefore, the neutral conductor shall be considered to be a current-carrying conductor.

NEC 2011

(3) Identification of Conductors in Multiconductor Extra-hard Usage Cords and Cables. Grounded (neutral) conductors shall be white without stripe or shall be identified by a distinctive white marking at their terminations. Grounding conductors shall be green with or without yellow stripe or shall be identified by a distinctive green marking at their terminations.

IV. Portable Switchboards on Stage

520.50 Road Show Connection Panel (A Type of Patch Panel)

NEC Language

A panel designed to allow for road show connection of portable stage switchboards to fixed lighting outlets by means of permanently installed

supplementary circuits. The panel, supplementary circuits, and outlets shall comply with 520.50(A) through (D).

Changed From NEC 2008

520.50(A) Load Circuits: This was revised to clarify that circuits are to originate from grounding-type polarized inlets.

NEC Language

(A) **Load Circuits.** Circuits shall originate from grounding-type polarized inlets of current and voltage rating that match the fixed-load receptacle.

(B) **Circuit Transfer.** Circuits that are transferred between fixed and portable switchboards shall have all circuit conductors transferred simultaneously.

(C) **Overcurrent Protection.** The supply devices of these supplementary circuits shall be protected by branch-circuit overcurrent protective devices. Each supplementary circuit, within the road show connection panel and theater, shall be protected by branch-circuit overcurrent protective devices installed within the road show connection panel.

(D) **Enclosure.** Panel construction shall be in accordance with Article 408.

520.52 Overcurrent Protection for Branch Circuits

Changed From NEC 2008

520.52: This was revised to specify that branch circuits originating in portable switchboards are not required to comply with 210.23.

NEC Language

Portable switchboards shall contain overcurrent protection for branch circuits. The requirements of 210.23 shall not apply.

V. Portable Stage Equipment Other Than Switchboards

520.62 Portable Power Distribution Units

NEC Language

Portable power distribution units shall comply with 520.62(A) through (E).

(A) **Enclosure.** The construction shall be such that no current-carrying part will be exposed.

Changed From NEC 2008

520.62(B) Receptacles and Overcurrent Protection: This was revised to specify "flexible" cords and to include cord connectors in addition to pendant receptacles.

NEC Language

(B) **Receptacles and Overcurrent Protection.** Receptacles shall comply with 520.45 and shall have branch-circuit overcurrent protection in the box. Fuses and

circuit breakers shall be protected against physical damage. Flexible cords or cables supplying pendant receptacles or cord connectors shall be listed for extra-hard usage.

(C) **Busbars and Terminals.** Busbars shall have an ampacity equal to the sum of the ampere ratings of all the circuits connected to the busbar. Lugs shall be provided for the connection of the master cable.

(D) **Flanged Surface Inlets.** Flanged surface inlets (recessed plugs) that are used to accept the power shall be rated in amperes.

(E) **Cable Arrangement.** Cables shall be adequately protected where they pass through enclosures and be arranged so that tension on the cable is not transmitted to the terminations.

520.65 Festoons

Changed From NEC 2008

520.65: Revised by adding requirement for insulation puncturing lamp holders to be attached only to stranded conductors.

NEC Language

Joints in festoon wiring shall be staggered. Where such lampholders have terminals of a type that puncture the insulation and make contact with the conductors, they shall be attached only to conductors of the stranded type. Lamps enclosed in lanterns or similar devices of combustible material shall be equipped with guards.

ARTICLE 525 — Carnivals, Circuses, Fairs, and Similar Events

This article covers the installation of portable wiring and equipment for carnivals, circuses, exhibitions, fairs, traveling attractions and similar functions.

The locations are similar to assembly occupancies, but they are not the same. There are two big differences:

1. Article 525 applications are temporary, while Article 518 occupancies are not.
2. Article 518 does not cover amusement rides and attractions, while Article 525 does.

I. General Requirements

525.5 Overhead Conductor Clearances

NEC Language

(A) **Vertical Clearances.** Conductors shall have a vertical clearance to ground in accordance with 225.18. These clearances shall apply only to wiring installed outside of tents and concessions.

(B) Clearance to Portable Structures.

(1) **Under 600 Volts.** Portable structures shall be maintained not less than 4.5 m (15 ft) in any direction from overhead conductors operating at 600 volts or less, except for the conductors supplying the portable structure. Portable structures included in 525.3(D) shall comply with Table 680.8.

Changed From NEC 2008

525.5(B)(2) **Over 600 Volts:** This was revised to clarify the space in which portable structures are not permitted to be located.

NEC Language

(2) **Over 600 Volts.** Portable structures shall not be located under or within a space that is located 4.5 m (15 ft) horizontally and extending vertically to grade of conductors operating in excess of 600 volts.

II. Power Sources**525.10 Services****NEC Language**

Services shall comply with 525.10(A) and (B).

(A) **Guarding.** Service equipment shall not be installed in a location that is accessible to unqualified persons, unless the equipment is lockable.

Changed From NEC 2008

525.10(B) **Mounting and Location:** This was revised by replacing “mounting” with “securely fastened.”

NEC Language

(B) **Mounting and Location.** Service equipment shall be securely fastened to a solid backing and be installed so as to be protected from the weather, unless of weatherproof construction.

III. Wiring Methods**525.21 Rides, Tents, and Concessions****Changed From NEC 2008**

525.21(A) **Disconnecting Means:** This was revised by replacing “disconnect switch” with “means to disconnect” and “disconnecting means.”

NEC Language

(A) **Disconnecting Means.** A means to disconnect each portable structure from all ungrounded conductors shall be provided. The disconnecting means shall be located within sight of and within 1.8 m (6 ft) of the operator’s station. The disconnecting means shall be readily accessible to the operator, including when the ride is in operation. Where accessible to unqualified persons, the disconnecting means shall be lockable. A shunt trip device that opens the fused

disconnect or circuit breaker when a switch located in the ride operator's console is closed shall be a permissible method of opening the circuit.

525.22 Portable Distribution or Termination Boxes

Portable distribution or termination boxes shall comply with 525.22(A) through (D).

Changed From NEC 2008

525.22(A) **Construction:** This was revised to specify the conditions under which live parts are permitted to be exposed.

NEC Language

(A) **Construction.** Boxes shall be designed so that no live parts are exposed except when necessary for examination, adjustment, servicing, or maintenance by qualified persons. Where installed outdoors, the box shall be of weatherproof construction and mounted so that the bottom of the enclosure is not less than 150 mm (6 in.) above the ground.

(B) **Busbars and Terminals.** Busbars shall have an ampere rating not less than the overcurrent device supplying the feeder supplying the box. Where conductors terminate directly on busbars, busbar connectors shall be provided.

(C) **Receptacles and Overcurrent Protection.** Receptacles shall have overcurrent protection installed within the box. The overcurrent protection shall not exceed the ampere rating of the receptacle, except as permitted in Article 430 for motor loads.

(D) **Single-Pole Connectors.** Where single-pole connectors are used, they shall comply with 530.22.

525.23 Ground-Fault Circuit-Interrupter (GFCI) Protection

Changed From NEC 2008

525.23: This was reorganized to improve usability and revised to clarify which receptacles are not required to be provided with GFCI protection.

NEC Language

(A) **Where GFCI Protection Is Required.** GFCI protection for personnel shall be provided for the following:

- (1) All 125-volt, single-phase, 15- and 20-ampere non-locking-type receptacles used for disassembly and reassembly or readily accessible to the general public
- (2) Equipment that is readily accessible to the general public and supplied from a 125-volt, single-phase, 15- or 20-ampere branch circuit

The ground-fault circuit-interrupter shall be permitted to be an integral part of the attachment plug or located in the power-supply cord within 300 mm (12 in.) of the

attachment plug. Listed cord sets incorporating ground-fault circuit-interrupter for personnel shall be permitted.

(B) **Where GFCI Protection Is Not Required.** Receptacles that are not accessible from grade level and that only facilitate quick disconnecting and reconnecting of electrical equipment shall not be required to be provided with GFCI protection. These receptacles shall be of the locking type.

(C) **Where GFCI Protection Is Not Permitted.** Egress lighting shall not be protected by a GFCI.

Article 530 — Motion Picture and Television Studios and Similar Locations

The requirements of Article 530 apply to television studios and motion picture studios using either film or electronic cameras, except as provided in 520.1, and exchanges, factories, laboratories, stages, or a portion of the building in which film or tape more than 22 mm (.086 in.) in width is exposed, developed, printed, cut, edited, rewound, repaired, or stored.

Informational Note: For methods of protecting against cellulose nitrate film hazards, see NFPA 40-2011, Standard for the Storage and Handling of Cellulose Nitrate Film.

The requirements for motion picture studios and for television studios are virtually the same and are intended to apply only to those locations presenting special hazards, that is, where film is handled or for temporary structures constructed of wood or other combustible material. In other areas of the facilities, the conditions are similar to those for theater stages, and the provisions of Article 520 apply for such areas as stages and dressing rooms.

II. Stage or Set

530.20 Grounding

Changed From NEC 2008

530.20: This was revised to include Type AC cable with an insulated equipment grounding conductor.

NEC Language

Type MC cable, Type MI cable, Type AC cable containing an insulated equipment grounding conductor, metal raceways, and all non-current-carrying metal parts of appliances, devices, and equipment shall be connected to an equipment grounding conductor. This shall not apply to pendant and portable lamps, to portable stage lighting and stage sound equipment, or to other portable and special stage equipment operating at not over 150 volts dc to ground.

530.21 Plugs and Receptacles

Changed From NEC 2008

530.21: This was revised to include cord connectors and flanged surface devices.

NEC Language

(A) **Rating.** Plugs and receptacles, including cord connectors and flanged surface devices, shall be rated in amperes. The voltage rating of the plugs and receptacles shall be not less than the nominal circuit voltage. Plug and receptacle ampere ratings for ac circuits shall not be less than the feeder or branch-circuit overcurrent device ampere rating. Table 210.21(B)(2) shall not apply.

(B) **Interchangeability.** Plugs and receptacles used in portable professional motion picture and television equipment shall be permitted to be interchangeable for ac or dc use on the same premises, provided they are listed for ac/dc use and marked in a suitable manner to identify the system to which they are connected.

V. Cellulose Nitrate Film Storage Vaults**530.51 Lamps in Cellulose Nitrate Film Storage Vaults*****Changed From NEC 2008***

530.51: This was revised by replacing "fixtures" with "luminaires."

NEC Language

Lamps in cellulose nitrate film storage vaults shall be installed in rigid luminaires of the glass-enclosed and gasketed type. Lamps shall be controlled by a switch having a pole in each ungrounded conductor. This switch shall be located outside of the vault and provided with a pilot light to indicate whether the switch is on or off. This switch shall disconnect from all sources of supply all ungrounded conductors terminating in any outlet in the vault.

ARTICLE 540 — Motion Picture Projection Rooms

The provisions of Article 540 apply to motion picture projection rooms, motion picture projectors, and associated equipment of the professional and nonprofessional types using incandescent, carbon arc, xenon, or other light source equipment that develops hazardous gases, dust, or radiation.

Informational Note: For further information, see NFPA 40-2011, Standard for the Storage and Handling of Cellulose Nitrate Film.

Hazardous locations, as defined in Article 500, do not include motion picture projection rooms, even though some of the older types of film, such as cellulose nitrate film (rarely used now), are highly flammable. Cellulose acetate film, called safety film, is in wide use today. Because film is not volatile at ordinary temperatures and no flammable gases are present, the wiring installation is not required to be suitable for hazardous locations, as defined in Article 500, but should be installed with special care to protect against the hazards of fire.

II. Equipment and Projectors of the Professional Type

540.11 Location of Associated Electrical Equipment

(A) **Motor Generator Sets, Transformers, Rectifiers, Rheostats, and Similar Equipment.** Motor-generator sets, transformers, rectifiers, rheostats, and similar equipment for the supply or control of current to projection or spotlight equipment shall, where nitrate film is used, be located in a separate room. Where placed in the projection room, they shall be located or guarded so that arcs or sparks cannot come in contact with film, and the commutator end or ends of motor generator sets shall comply with one of the conditions in 540.11(A)(1) through (A)(6).

(1) **Types.** Be of the totally enclosed, enclosed fan-cooled, or enclosed pipe-ventilated type.

Changed From NEC 2008

540.11(A)(2) **Separate Rooms or Housings:** This was revised to require "approved" ventilation.

NEC Language

(2) **Separate Rooms or Housings.** Be enclosed in separate rooms or housings built of noncombustible material constructed so as to exclude flyings or lint with approved ventilation from a source of clean air.

ARTICLE 545 — Manufactured Buildings

Article 545 covers requirements for a manufactured building and building components as herein defined. The term manufactured building is defined in 545.2.

With respect to this construction method for dwelling units, the distinction between manufactured buildings covered in Article 545 and manufactured homes as covered and defined in Article 550 is important. The most distinguishing feature between the two types of structures is how they are placed on the building site. Manufactured homes are built on a chassis and installed on site with or without a permanent foundation. Manufactured buildings are generally constructed within a factory or assembly plant and then transported to the building site. They are not built on a chassis and are designed to be installed on a permanent foundation.

In addition, the organizations responsible for construction standards for these units differ. In the case of manufactured homes, the U.S. Department of Housing and Urban Development, 24 CFR 3280, Manufactured Home Construction and Safety Standards, contains construction requirements for manufactured homes. Manufactured homes bear a nameplate documenting that the unit was constructed in accordance with the federal standard. In accordance with federal law, this identifying mark is universally recognized throughout the United States.

Manufactured building construction standards generally are promulgated through state or local units of government and typically have an information sheet (often inside the cabinet below the kitchen sink) indicating the applicable building, electrical, plumbing, and mechanical codes to which the building was constructed. Manufactured building construction can be directly affected by differences in building construction regulations among those jurisdictions responsible for regulating this type of construction.

545.2 Definitions

NEC Language

Building Component. Any subsystem, subassembly, or other system designed for use in or integral with or as part of a structure, which can include structural, electrical, mechanical, plumbing, and fire protection systems, and other systems affecting health and safety.

Building System. Plans, specifications, and documentation for a system of manufactured building or for a type or a system of building components, which can include structural, electrical, mechanical, plumbing, and fire protection systems, and other systems affecting health and safety, and including such variations thereof as are specifically permitted by regulation, and which variations are submitted as part of the building system or amendment thereto.

Changed From NEC 2008

545.2. Closed Construction: This was revised to clarify that components cannot be inspected “after” the manufactured building has been installed at building site.

NEC Language

Closed Construction. Any building, building component, assembly, or system manufactured in such a manner that all concealed parts of processes of manufacture cannot be inspected after installation at the building site without disassembly, damage, or destruction.

Manufactured Building. Any building that is of closed construction and is made or assembled in manufacturing facilities on or off the building site for installation, or for assembly and installation on the building site, other than manufactured homes, mobile homes, park trailers, or recreational vehicles.

Article 547 — Agricultural Buildings

Two factors have a tremendous influence on the lifespan of agricultural equipment: dust and moisture.

Dust gets into mechanisms and causes premature wear. With electricity on the scene, dust adds two other dangers: fire and explosion. Dust from hay, grain, and fertilizer is highly flammable. Litter materials, such as straw, are also highly flammable. Excrement from farm animals may cause corrosive vapors that eat at mechanical equipment and wiring methods and can cause electrical equipment

to fail. For this reason, Article 547 includes requirements for dealing with dust and corrosion.

Another factor to consider in agricultural buildings is moisture, which causes corrosion. Water is present for many reasons, including wash down. Thus, this article has requirements for dealing with wet and damp environments, and also includes other requirements. For example, it requires you to install equipotential planes in all concrete floor confinement areas of livestock buildings containing metallic equipment accessible to animals and likely to become energized.

Livestock animals have a low tolerance to small levels of stray electrical current, which can cause loss of milk production and, at times, livestock fatality. As a result, the NEC contains specific requirements for an equipotential plane in buildings that house livestock.

547.5 Wiring Methods

Changed From NEC 2008

547.5(G) Receptacles: This was revised to delete provision permitting a single receptacle without GFCI protection where located within 3 ft. of a GFCI protected receptacle.

NEC Language

(G) Receptacles. All 125-volt, single-phase, 15- and 20-ampere general-purpose receptacles installed in the locations listed in (1) through (4) shall have ground-fault circuit-interrupter protection:

- (1) Areas having an equipotential plane
- (2) Outdoors
- (3) Damp or wet locations
- (4) Dirt confinement areas for livestock

547.8 Luminaires

NEC Language

Luminaires shall comply with 547.8(A) through (C).

(A) Minimize the Entrance of Dust. Luminaires shall be installed to minimize the entrance of dust, foreign matter, moisture, and corrosive material.

(B) Exposed to Physical Damage. Luminaires exposed to physical damage shall be protected by a suitable guard.

Changed From NEC 2008

547.8(C) Exposed to Water: This was revised to specify "listed as suitable for use in a wet location."

NEC Language

(C) **Exposed to Water.** Luminaires exposed to water from condensation, building cleansing water, or solution shall be listed as suitable for use in wet locations.

547.9 Electrical Supply to Building(s) or Structure(s) from a Distribution Point**NEC Language**

A distribution point shall be permitted to supply any building or structure located on the same premises. The overhead electrical supply shall comply with 547.9(A) and (B), or with 547.9(C). The underground electrical supply shall comply with 547.9(C).

(A) **Site-Isolating Device.** Site-isolating devices shall comply with 547.9(A)(1) through (A)(10).

(1) **Where Required.** A site-isolating device shall be installed at the distribution point where two or more agricultural buildings or structures are supplied from the distribution point.

Changed From NEC 2008

547.9(A)(2) **Location:** This was revised to specify location and height above grade for the site-isolating device.

NEC Language

(2) **Location.** The site-isolating device shall be pole-mounted and be not less than the height above grade required by 230.24 for the conductors it supplies.

(3) **Operation.** The site-isolating device shall simultaneously disconnect all ungrounded service conductors from the premises wiring.

(4) **Bonding Provisions.** The site-isolating device enclosure shall be connected to the grounded circuit conductor and the grounding electrode system.

(5) **Grounding.** At the site-isolating device, the system grounded conductor shall be connected to a grounding electrode system via a grounding electrode conductor.

(6) **Rating.** The site-isolating device shall be rated for the calculated load as determined by Part V of Article 220.

(7) **Overcurrent Protection.** The site-isolating device shall not be required to provide overcurrent protection.

(8) **Accessibility.** The site-isolating device shall be capable of being remotely operated by an operating handle installed at a readily accessible location. The operating handle of the site-isolating device, when in its highest position, shall not be more than 2.0 m (6 ft 7 in.) above grade or a working platform.

(9) **Series Devices.** An additional site-isolating device for the premises wiring system shall not be required where a site-isolating device meeting all applicable

requirements of this section is provided by the serving utility as part of their service requirements.

(10) **Marking.** A site-isolating device shall be permanently marked to identify it as a site-isolating device. This marking shall be located on the operating handle or immediately adjacent thereto.

(B) **Service Disconnecting Means and Overcurrent Protection at the Building(s) or Structure(s).** Where the service disconnecting means and overcurrent protection are located at the building(s) or structure(s), the requirements of 547.9(B)(1) through (B)(3) shall apply.

(1) **Conductor Sizing.** The supply conductors shall be sized in accordance with Part V of Article 220.

(2) **Conductor Installation.** The supply conductors shall be installed in accordance with the requirements of Part II of Article 225.

(3) **Grounding and Bonding.** For each building or structure, grounding and bonding of the supply conductors shall be in accordance with the requirements of 250.32, and the following conditions shall be met:

(1) The equipment grounding conductor is not smaller than the largest supply conductor if of the same material, or is adjusted in size in accordance with the equivalent size columns of Table 250.122 if of different materials.

(2) The equipment grounding conductor is connected to the grounded circuit conductor and the site-isolating device at the distribution point.

Changed From NEC 2008

547.9(C) Service Disconnecting Means and Overcurrent Protection at the Distribution Point: This was revised to include branch circuits that supply buildings or structures.

NEC Language

(C) **Service Disconnecting Means and Overcurrent Protection at the Distribution Point.** Where the service disconnecting means and overcurrent protection for each set of feeders or branch circuits are located at the distribution point, the feeders or branch circuits to buildings or structures shall comply with the provisions of 250.32 and Article 225, Parts I and II.

Informational Note: Methods to reduce neutral-to-earth voltages in livestock facilities include supplying buildings or structures with 4-wire single-phase services, sizing 3-wire single-phase service and feeder conductors to limit voltage drop to 2 percent, and connecting loads line-to-line.

Changed From NEC 2008

547.9(D) Identification: This was revised to specify that the requirement applies to sites supplied by more than one "distribution point."

NEC Language

(D) **Identification.** Where a site is supplied by more than one distribution point, a permanent plaque or directory shall be installed at each of these distribution points denoting the location of each of the other distribution points and the buildings or structures served by each.

547.10 Equipotential Planes and Bonding of Equipotential Planes**NEC Language**

The installation and bonding of equipotential planes shall comply with 547.10(A) and (B). For the purposes of this section, the term livestock shall not include poultry.

(A) **Where Required.** Equipotential planes shall be installed where required in (A)(1) and (A)(2).

(1) **Indoors.** Equipotential planes shall be installed in confinement areas with concrete floors where metallic equipment is located that may become energized and is accessible to livestock.

(2) **Outdoors.** Equipotential planes shall be installed in concrete slabs where metallic equipment is located that may become energized and is accessible to livestock.

The equipotential plane shall encompass the area where the livestock stands while accessing metallic equipment that may become energized.

Changed From NEC 2008

547.10(B) Bonding: This was revised to require that the equipotential plane bonding conductor be a solid copper conductor.

NEC Language

(B) **Bonding.** Equipotential planes shall be connected to the electrical grounding system. The bonding conductor shall be solid copper, insulated, covered or bare, and not smaller than 8 AWG. The means of bonding to wire mesh or conductive elements shall be by pressure connectors or clamps of brass, copper, copper alloy, or an equally substantial approved means. Slatted floors that are supported by structures that are a part of an equipotential plane shall not require bonding.

Informational Note No. 1: Methods to establish equipotential planes are described in American Society of Agricultural and Biological Engineers (ASABE) EP473.2-2001, Equipotential Planes in Animal Containment Areas.

Informational Note No. 2: Methods for safe installation of livestock waterers are described in American Society of Agricultural and Biological Engineers (ASABE) EP342.2-1995, Safety for Electrically Heated Livestock Waterers.

Informational Note No. 3: Low grounding electrode system resistances may reduce potential differences in livestock facilities.

ARTICLE 550 — Mobile Homes, Manufactured Homes, and Mobile Home Parks

Among dwelling types, mobile homes have the highest rate of fire. Article 550 addresses some of the causes of those fires with the intent of reducing these statistics.

Article 550 recognizes that the same structures used for mobile or manufactured homes are also used for non-dwelling purposes, such as construction offices or clinics. Thus, it excludes those structures from the 100A minimum service requirement.

According to the NEC, there is a difference between a mobile home and a manufactured home, and article 550 has different requirements for each. For example, you cannot locate service equipment on a mobile home. However, you can install service equipment on a manufactured home (provided you meet seven conditions).

Mobile home and manufactured homes are not covered by same building codes as a site-built home, but are covered instead by HUD standards. According to HUD, both are referred to as manufactured homes and the term *mobile home* has not been used for many years. This disparity between the NEC and industry practices can cause confusion, so it is important to read the NEC carefully as you apply this article.

II. Mobile and Manufactured Homes

550.13 Receptacle Outlets

NEC Language

(A) Grounding-Type Receptacle Outlets. All receptacle outlets shall comply with the following:

- (1) Be of grounding type
- (2) Be installed according to 406.4
- (3) Except where supplying specific appliances, be 15- or 20-ampere, 125-volt, either single or multiple type, and accept parallel-blade attachment plugs

Changed From NEC 2008

550.13(B) **Ground-Fault Circuit Interrupters (GFCI)**: This was revised by deleting exception and adding provision referencing to exceptions specified in 210.8(A).

NEC Language

(B) **Ground-Fault Circuit Interrupters (GFCI)**. All 125-volt, single-phase, 15- and 20-ampere receptacle outlets installed outdoors, in compartments accessible from outside the unit, or in bathrooms, including receptacles in luminaires, shall have GFCI protection. GFCI protection shall be provided for receptacle outlets

serving countertops in kitchens and receptacle outlets located within 1.8 m (6 ft) of a wet bar sink. The exceptions in 210.8(A) shall be permitted.

Feeders supplying branch circuits shall be permitted to be protected by a ground-fault circuit-interrupter in lieu of the provision for such interrupters specified herein.

Changed From NEC 2008

550.13(F)(1): This was revised to define further the locations where receptacles cannot be installed in relation to a bathtub or shower space.

NEC Language

(1) Receptacle outlets shall not be installed within or directly over a bathtub or shower space.

550.15 Wiring Methods and Materials

NEC Language

Except as specifically limited in this section, the wiring methods and materials included in this Code shall be used in mobile homes. Aluminum conductors, aluminum alloy conductors, and aluminum core conductors such as copper-clad aluminum shall not be acceptable for use as branch-circuit wiring.

Changed From NEC 2008

550.15(H) **Under-Chassis Wiring (Exposed to Weather)**: This was revised by incorporating exception into requirement and adding direct burial requirement.

NEC Language

(H) **Under-Chassis Wiring (Exposed to Weather)**. Where outdoor or under-chassis line-voltage (120 volts, nominal, or higher) wiring is exposed to moisture or physical damage, it shall be protected by rigid metal conduit or intermediate metal conduit, except as provided in (1) or (2). The conductors shall be suitable for wet locations.

(1) Where closely routed against frames and equipment enclosures, reinforced thermosetting resin conduit (RTRC) listed for aboveground use, Type MI cable, electrical metallic tubing, or rigid polyvinyl chloride conduit (PVC) shall be permitted.

(2) Where extending vertically from a direct-burial depth of at least 457 mm (18 in.) below grade and terminated to a factory-installed conduit or enclosure, Schedule 80 PVC or RTRC listed for exposure to physical damage.

550.25 Arc-Fault Circuit-Interrupter Protection

Changed From NEC 2008

550.25: This was revised to expand the areas where AFCI protection is required.

NEC Language

(A) **Definition.** Arc-fault circuit interrupters are defined in Article 100.

(B) **Mobile Homes and Manufactured Homes.** All 120-volt branch circuits that supply 15- and 20-ampere outlets installed in family rooms, dining rooms, living rooms, parlors, libraries, dens, bedrooms, sunrooms, recreation rooms, closets, hallways, or similar rooms or areas of mobile homes and manufactured homes shall comply with 210.12.

ARTICLE 551 — Recreational Vehicles and Recreational Vehicle Parks

The provisions of article 551 cover the electrical conductors and equipment other than low-voltage and automotive vehicle circuits or extensions thereof, installed within or on recreational vehicles, the conductors that connect recreational vehicles to a supply of electricity, and the installation of equipment and devices related to electrical installations within a recreational vehicle park.

Laws in many states require a factory inspection of recreational vehicles by either a governmental or a private inspection agency. NFPA 1192, Standard on Recreational Vehicles, is widely accepted by the recreational vehicle (RV) industry and those authorities having jurisdiction responsible for ensuring that RVs are built to a recognized safety standard. Section 4.4 of NFPA 1192-2008 requires compliance with Parts I, III, IV, V, and VI of Article 551 and requires compliance with ANSI/RVIA 12V, Low Voltage Systems in Conversion and Recreational Vehicles, for the RV electrical systems rated 24 volts, nominal, or less.

Informational Note: For information on low-voltage systems, refer to NFPA 1192-2008, Standard on Recreational Vehicles, and ANSI/RVIA 12V-2005, Standard for Low Voltage Systems in Conversion and Recreational Vehicles.

I. General**551.2 Definitions**

(See Article 100 for additional definitions.)

Changed From NEC 2008

551.2. Air-Conditioning or Comfort-Cooling Equipment: This was revised to indicate that the identified functions may occur individually.

NEC Language

Air-Conditioning or Comfort-Cooling Equipment. All of that equipment intended or installed for the purpose of processing the treatment of air so as to control simultaneously or individually its temperature, humidity, cleanliness, and distribution to meet the requirements of the conditioned space.

Changed From NEC 2008

551.2. Low Voltage: This was revised to not limit low-voltage power sources.

NEC Language

Low Voltage. An electromotive force rated 24 volts, nominal, or less.

III. Other Power Sources**551.30 Generator Installations****NEC Language**

(A) **Mounting.** Generators shall be mounted in such a manner as to be effectively bonded to the recreational vehicle chassis.

Changed From NEC 2008

551.30(B) **Generator Protection:** This was revised to require automatic transfer switches be listed for emergency or optional standby use.

NEC Language

(B) **Generator Protection.** Equipment shall be installed to ensure that the current-carrying conductors from the engine generator and from an outside source are not connected to a vehicle circuit at the same time. Automatic transfer switches in such applications shall be listed for use in one of the following:

- (1) Emergency systems
- (2) Optional standby systems

Receptacles used as disconnecting means shall be accessible (as applied to wiring methods) and capable of interrupting their rated current without hazard to the operator.

551.33 Alternate Source Restrictions**Changed From NEC 2008**

551.33: This was revised to require automatic transfer switches be listed for emergency or optional standby use.

NEC Language

Transfer equipment, if not integral with the listed power source, shall be installed to ensure that the current-carrying conductors from other sources of ac power and from an outside source are not connected to the vehicle circuit at the same time. Automatic transfer switches in such applications shall be listed for use in one of the following:

- (1) Emergency systems
- (2) Optional standby systems

IV. Nominal 120-Volt or 120/240-Volt Systems

551.46 Means for Connecting to Power Supply

NEC Language

(A) **Assembly.** The power-supply assembly or assemblies shall be factory supplied or factory installed and be of one of the types specified herein.

(1) **Separable.** Where a separable power-supply assembly consisting of a cord with a female connector and molded attachment plug cap is provided, the vehicle shall be equipped with a permanently mounted, flanged surface inlet (male, recessed-type motor-base attachment plug) wired directly to the distribution panelboard by an approved wiring method. The attachment plug cap shall be of a listed type.

Changed From NEC 2008

551.46(A)(2) **Permanently Connected:** This was revised to include storage and removal of cord assembly.

NEC Language

(2) **Permanently Connected.** Each power-supply assembly shall be connected directly to the terminals of the distribution panelboard or conductors within a junction box and provided with means to prevent strain from being transmitted to the terminals. The ampacity of the conductors between each junction box and the terminals of each distribution panelboard shall be at least equal to the ampacity of the power-supply cord. The supply end of the assembly shall be equipped with an attachment plug of the type described in 551.46(C). Where the cord passes through the walls or floors, it shall be protected by means of conduit and bushings or equivalent. The cord assembly shall have permanent provisions for protection against corrosion and mechanical damage while the vehicle is in transit, or while the cord assembly is being stored or removed for use.

551.47 Wiring Methods

Changed From NEC 2008

551.47(I) **Cable Supports:** The NEC revised the requirement for cable support.

NEC Language

(I) **Cable Supports.** Where connected with cable connectors or clamps, cables shall be supported within 300 mm (12 in.) of outlet boxes, distribution panelboards, and splice boxes on appliances. Supports shall be provided at intervals not exceeding 1.4 m (4½ ft) at other places.

(J) **Nonmetallic Box Without Cable Clamps.** Nonmetallic-sheathed cables shall be supported within 200 mm (8 in.) of a nonmetallic outlet box without cable clamps. Where wiring devices with integral enclosures are employed with a loop of extra cable to permit future replacement of the device, the cable loop shall be considered as an integral portion of the device.

(K) **Physical Damage.** Where subject to physical damage, exposed nonmetallic cable shall be protected by covering boards, guard strips, raceways, or other means.

Changed From NEC 2008

551.47(L) **Receptacle Faceplates:** This was revised to reference metal and nonmetallic faceplate requirements in Article 406.

NEC Language

(L) **Receptacle Faceplates.** Metal faceplates shall comply with Section 406.5(A). Nonmetallic faceplates shall comply with Section 406.5(C).

Changed From NEC 2008

551.47(P)(2) **Direct Wired:** This was revised to permit RTRC listed for exposure to physical damage.

NEC Language

(2) **Direct Wired.** That portion of a branch circuit that is installed in an expandable unit shall be permitted to be connected to the portion of the branch circuit in the main body of the vehicle by means of flexible cord installed in accordance with 551.47(P)(2)(a) through (P)(2)(e) or other approved wiring method.

- (a) The flexible cord shall be listed for hard usage and for use in wet locations.
- (b) The flexible cord shall be permitted to be exposed on the underside of the vehicle.
- (c) The flexible cord shall be permitted to pass through the interior of a wall or floor assembly or both a maximum concealed length of 600 mm (24 in.) before terminating at an outlet or junction box.
- (d) Where concealed, the flexible cord shall be installed in nonflexible conduit or tubing that is continuous from the outlet or junction box inside the recreational vehicle to a weatherproof outlet box, junction box, or strain relief fitting listed for use in wet locations that is located on the underside of the recreational vehicle. The outer jacket of the flexible cord shall be continuous into the outlet or junction box.
- (e) Where the flexible cord passes through the floor to an exposed area inside of the recreational vehicle, it shall be protected by means of conduit and bushings or equivalent.

Where subject to physical damage, the flexible cord shall be protected with RMC, IMC, Schedule 80 PVC, reinforced thermosetting resin conduit (RTRC) listed for exposure to physical damage, or other approved means and shall extend at least 150 mm (6 in.) above the floor. A means shall be provided to secure the flexible cord where it enters the recreational vehicle.

(Q) Prewiring for Air-Conditioning Installation. Prewiring installed for the purpose of facilitating future air-conditioning installation shall comply with the applicable portions of this article and the following:

- (1) An overcurrent protective device with a rating compatible with the circuit conductors shall be installed in the distribution panelboard and wiring connections completed.
- (2) The load end of the circuit shall terminate in a junction box with a blank cover or other listed enclosure. Where a junction box with a blank cover is used, the free ends of the conductors shall be adequately capped or taped.
- (3) A label conforming to 551.46(D) shall be placed on or adjacent to the junction box and shall read as follows:

AIR-CONDITIONING CIRCUIT.
 THIS CONNECTION IS FOR AIR CONDITIONERS
 RATED 110–125-VOLT AC, 60 HZ,
 ___ AMPERES MAXIMUM.
 DO NOT EXCEED CIRCUIT RATING.

An ampere rating, not to exceed 80 percent of the circuit rating, shall be legibly marked in the blank space.

- (4) The circuit shall serve no other purpose.

(R) Prewiring for Generator Installation. Prewiring installed for the purpose of facilitating future generator installation shall comply with the other applicable portions of this article and the following:

Changed From NEC 2008

551.47(R)(1): This was revised to specify where conductor load information is located.

NEC Language

- (1) Circuit conductors shall be appropriately sized in relation to the anticipated load as stated on the label required in (R)(4).
- (2) Where junction boxes are utilized at either of the circuit originating or terminus points, free ends of the conductors shall be adequately capped or taped.
- (3) Where devices such as receptacle outlet, transfer switch, and so forth, are installed, the installation shall be complete, including circuit conductor connections. All devices shall be listed and appropriately rated.

Changed From NEC 2008

551.47(R)(4): Revised label requirement to clarify that ampere rating applies to overcurrent protective device.

NEC Language

(4) A label conforming to 551.46(D) shall be placed on the cover of each junction box containing incomplete circuitry and shall read, as appropriate, either

<p>GENERATOR</p> <p>ONLY INSTALL A GENERATOR LISTED</p> <p>SPECIFICALLY FOR RV USE</p> <p>HAVING OVERCURRENT PROTECTION</p> <p>RATED 110/125-VOLT AC,</p> <p>60 HZ, _____ AMPERES MAXIMUM.</p>
--

Or

<p>GENERATOR</p> <p>ONLY INSTALL A GENERATOR LISTED</p> <p>SPECIFICALLY FOR RV USE</p> <p>HAVING OVERCURRENT PROTECTION</p> <p>RATED 120/240-VOLT AC,</p> <p>60 HZ, _____ AMPERES MAXIMUM.</p>
--

The correct ampere rating shall be legibly marked in the blank space.

(S) **Prewiring for Other Circuits.** Prewiring installed for the purpose of installing other appliances or devices shall comply with the applicable portions of this article and the following:

- (1) An overcurrent protection device with a rating compatible with the circuit conductors shall be installed in the distribution panelboard with wiring connections completed.
- (2) The load end of the circuit shall terminate in a junction box with a blank cover or a device listed for the purpose. Where a junction box with blank cover is used, the free ends of the conductors shall be adequately capped or taped.
- (3) A label conforming to 551.46(D) shall be placed on or adjacent to the junction box or device listed for the purpose and shall read as follows:

<p>THIS CONNECTION IS FOR _____ RATED _____ VOLT AC, 60 HZ, _____ AMPERES MAXIMUM. DO NOT EXCEED CIRCUIT RATING.</p>
--

An ampere rating not to exceed 80 percent of the circuit rating shall be legibly marked in the blank space.

551.54 Grounding

Changed From NEC 2008

<p>551.54: This was revised to include industry recognized term "neutral conductor."</p>
--

NEC Language

(See also 551.56 on bonding of non-current-carrying metal parts.)

(A) **Power-Supply Grounding.** The grounding conductor in the supply cord or feeder shall be connected to the grounding bus or other approved grounding means in the distribution panelboard.

(B) **Distribution Panelboard.** The distribution panelboard shall have a grounding bus with terminals for all grounding conductors or other approved grounding means.

(C) **Insulated Grounded Conductor (Neutral Conductor).** The grounded circuit conductor (neutral conductor) shall be insulated from the equipment grounding conductors and from equipment enclosures and other grounded parts. The grounded circuit conductor (neutral conductor) terminals in the distribution panelboard and in ranges, clothes dryers, counter-mounted cooking units, and wall-mounted ovens shall be insulated from the equipment enclosure. Bonding screws, straps, or buses in the distribution panelboard or in appliances shall be removed and discarded. Connection of electric ranges and electric clothes dryers utilizing a grounded conductor, if cord-connected, shall be made with 4-conductor cord and 3-pole, 4-wire grounding-type plug caps and receptacles.

551.55 Interior Equipment Grounding**NEC Language****Changed From NEC 2008**

551.55(D) **Grounding Connection in Nonmetallic Box:** Revised "grounding conductor" to "equipment grounding conductor."

NEC Language

(D) **Grounding Connection in Nonmetallic Box.** A connection between the one or more **equipment grounding conductors** brought into a nonmetallic outlet box shall be so arranged that a connection of the equipment grounding conductor can be made to any fitting or device in that box that requires grounding.

V. Factory Tests**551.60 Factory Tests (Electrical)****Changed From NEC 2008**

551.60: This was revised to include requirement that test be performed per the instructions provided by the manufacturer of the test equipment.

NEC Language

Each recreational vehicle designed with a 120-volt or a 120/240-volt electrical system shall withstand the applied potential without electrical breakdown of a 1-minute, 900-volt ac or 1280-volt dc dielectric strength test, or a 1-second, 1080-volt ac or 1530-volt dc dielectric strength test, with all switches closed, between ungrounded and grounded conductors and the recreational vehicle ground.

During the test, all switches and other controls shall be in the "on" position. Fixtures, including luminaires and permanently installed appliances, shall not be required to withstand this test. The test shall be performed after branch circuits are complete prior to energizing the system and again after all outer coverings and cabinetry have been secured. The dielectric test shall be performed in accordance with the test equipment manufacturer's written instructions.

Each recreational vehicle shall be subjected to all of the following:

- (1) A continuity test to ensure that all metal parts are properly bonded
- (2) Operational tests to demonstrate that all equipment is properly connected and in working order
- (3) Polarity checks to determine that connections have been properly made
- (4) GFCI test to demonstrate that the ground fault protection device(s) installed on the recreational vehicle are operating properly.

VI. Recreational Vehicle Parks

551.80 Underground Service, Feeder, Branch-Circuit, and Recreational Vehicle Site Feeder-Circuit Conductors

NEC Language

(A) **General.** All direct-burial conductors, including the equipment grounding conductor if of aluminum, shall be insulated and identified for the use. All conductors shall be continuous from equipment to equipment. All splices and taps shall be made in approved junction boxes or by use of material listed and identified for the purpose.

Changed From NEC 2008

551.80(B) **Protection Against Physical Damage:** This was revised to identify specific nonmetallic conduits permitted to be used.

NEC Language

(B) **Protection Against Physical Damage.** Direct-buried conductors and cables entering or leaving a trench shall be protected by rigid metal conduit, intermediate metal conduit, electrical metallic tubing with supplementary corrosion protection, rigid polyvinyl chloride conduit (PVC), nonmetallic underground conduit with conductors (NUCC), high density polyethylene conduit (HDPE), reinforced thermosetting resin conduit (RTRC), liquidtight flexible nonmetallic conduit, liquidtight flexible metal conduit, or other approved raceways or enclosures. Where subject to physical damage, the conductors or cables shall be protected by rigid metal conduit, intermediate metal conduit, Schedule 80 PVC conduit, or RTRC listed for exposure to physical damage. All such protection shall extend at least 450 mm (18 in.) into the trench from finished grade.

Informational Note: See 300.5 and Article 340 for conductors or Type UF cable used underground or in direct burial in earth.

ARTICLE 552 — Park Trailers

The provisions of Article 552 cover the electrical conductors and equipment installed within or on park trailers not covered fully under Articles 550 and 551.

The scope of Article 552 covers park trailers that have a single chassis and wheels, that do not exceed 400 ft² (set up), and that are not used as permanent residences. Additionally, Article 552 does not apply to units that meet the definition of park trailer (see 552.2) but are used for commercial purposes (see 552.4).

Park trailers equipped with electrical loads similar to those used in mobile homes are not uncommon. It is also not uncommon for a park trailer to be located in the same park trailer community for several years without relocation.

Park trailers are somewhat similar to mobile homes and recreational vehicles, and many requirements in Article 552 are the same as or similar to those contained in Articles 550 and 551. Article 552, therefore, is similar in structure to Articles 550 and 551.

IV. Nominal 120-Volt or 120/240-Volt Systems

552.46 Branch Circuits.

NEC Language

Branch circuits shall be determined in accordance with 552.46(A) and (B).

(A) **Two to Five 15- or 20-Ampere Circuits.** Two to five 15- or 20-ampere circuits to supply lights, receptacle outlets, and fixed appliances shall be permitted. Such park trailers shall be equipped with a distribution panelboard rated at 120 volts maximum with a 30-ampere rated main power supply assembly. Not more than two 120-volt thermostatically controlled appliances (i.e., air conditioner and water heater) shall be installed in such systems unless appliance isolation switching, energy management systems, or similar methods are used.

Exception: Additional 15- or 20-ampere circuits shall be permitted where a listed energy management system rated at 30 amperes maximum is employed within the system.

(B) **More Than Five Circuits.** Where more than five circuits are needed, they shall be determined in accordance with 552.46(B)(1), (B)(2), and (B)(3).

Changed From NEC 2008

552.46(B)(1) Lighting: The NEC revised appliance terminology for consistency with other NEC requirements, and to include ranges and counter-mounted cooking units.

NEC Language

(1) **Lighting.** Based on 33 volt-amperes/m² (3 VA/ft²) multiplied by the outside dimensions of the park trailer (coupler excluded) divided by 120 volts to determine the number of 15- or 20-ampere lighting area circuits, for example,

$$\frac{3 \times \text{length} \times \text{width}}{120 \times 15 \text{ (or 20)}} \\ = \text{No. of 15- (or 20-) ampere circuits}$$

The lighting circuits shall be permitted to serve listed cord-connected kitchen waste disposers and to provide power for supplemental equipment and lighting on gas-fired ranges, ovens, or counter-mounted cooking units.

(2) **Small Appliances.** Small-appliance branch circuits shall be installed in accordance with 210.11(C)(1).

(3) **General Appliances.** (including furnace, water heater, space heater, range, and central or room air conditioner, etc.) An individual branch circuit shall be permitted to supply any load for which it is rated. There shall be one or more circuits of adequate rating in accordance with (a) through (d).

Informational Note No. 1: For the laundry branch circuit, see 210.11(C)(2).

Informational Note No. 2: For central air conditioning, see Article 440

(a) The total rating of fixed appliances shall not exceed 50 percent of the circuit rating if lighting outlets, general-use receptacles, or both are also supplied.

(b) For fixed appliances with a motor(s) larger than horsepower, the total calculated load shall be based on 125 percent of the largest motor plus the sum of the other loads. Where a branch circuit supplies continuous load(s) or any combination of continuous and noncontinuous loads, the branch-circuit conductor size shall be in accordance with 210.19(A).

(c) The rating of a single cord-and-plug-connected appliance supplied by other than an individual branch circuit shall not exceed 80 percent of the circuit rating.

(d) The rating of a range branch circuit shall be based on the range demand as specified for ranges in 552.47(B)(5).

552.59 Outdoor Outlets, Fixtures, Including Luminaires, Air-Cooling Equipment, and So On

Changed From NEC 2008

552.59(A) **Listed for Outdoor Use:** This was revised to reference requirements in Articles 404 and 406 for switches, circuit breakers, and receptacles installed outdoors.

NEC Language

(A) **Listed for Outdoor Use.** Outdoor fixtures, including luminaires, and equipment shall be listed for outdoor use. Outdoor receptacle outlets shall be in

accordance with 406.9(A) and (B). Switches and circuit breakers installed outdoors shall comply with 404.4.

ARTICLE 553 — Floating Buildings

Article 553 covers wiring, services, feeders, and grounding for floating buildings.

Although the Code does not cover electrical installations in ships or watercraft, it does cover installations for floating buildings. Floating buildings may be restaurants, aquariums, dwelling units or many other occupancies. All other applicable articles of the Code apply to these floating buildings.

II. Services and Feeders

553.4 Location of Service Equipment

Changed From NEC 2008

553.4: The NEC added a new requirement for main overcurrent device to have ground fault protection not exceeding 100 mA.

NEC Language

The service equipment for a floating building shall be located adjacent to, but not in or on, the building or any floating structure. The main overcurrent protective device that feeds the floating structure shall have ground fault protection not exceeding 100 mA. Ground fault protection of each individual branch or feeder circuit shall be permitted as a suitable alternative.

ARTICLE 555 — Marinas and Boatyards

To provide power to a marina or boatyard, you must allow for variations in water level between the point of use and the power source. Water level is not constant. Ocean tides rise and fall, while lakes and rivers vary in depth in response to rain.

Article 555 begins with the concept of the electrical datum plane. You might think of it as the border of a "demilitarized zone" for electrical equipment. Or, you can think of it as a line that marks the beginning of a "no man's land" where you simply don't place electrical equipment.

Once you determine where this plane is, don't locate transformers, connections, or receptacles below that line.

555.2 Definitions

NEC Language

Changed From NEC 2008

555.2. **Marine Power Outlet:** This was revised to include "distribution panelboards."

NEC Language

Marine Power Outlet. An enclosed assembly that can include equipment such as receptacles, circuit breakers, fused switches, fuses, watt-hour meter(s), *distribution panelboards*, and monitoring means approved for marine use.

555.3 Ground-Fault Protection**Changed From NEC 2008**

555.3: The NEC added a new requirement for main overcurrent device to have ground fault protection not exceeding 100 mA.

NEC Language

The main overcurrent protective device that feeds the marina shall have ground fault protection not exceeding 100 mA. Ground-fault protection of each individual branch or feeder circuit shall be permitted as a suitable alternative.

555.12 Load Calculations for Service and Feeder Conductors**NEC Language**

General lighting and other loads shall be calculated in accordance with Part III of Article 220, and, in addition, the demand factors set forth in Table 555.12 shall be permitted for each service and/or feeder circuit supplying receptacles that provide shore power for boats. These calculations shall be permitted to be modified as indicated in notes (1) and (2) to Table 555.12. Where demand factors of Table 555.12 are applied, the demand factor specified in 220.61(B) shall not be permitted.

Informational Note: These demand factors may be inadequate in areas of extreme hot or cold temperatures with loaded circuits for heating, air-conditioning, or refrigerating equipment.

Changed From NEC 2008

Table 555.12: The NEC revised the table heading to specify "shore power" receptacles.

Number of Shore Power Receptacles	Sum of the Rating of the Receptacles (%)
1-4	100
5-8	90
9-14	80
15-30	70
31-40	60
41-50	50
51-70	40
≥71	30

Notes:

- Where shore power accommodations provide two receptacles specifically for an individual boat slip and these receptacles have different voltages (for example, one 30 ampere, 125 volt and one 50 ampere, 125/250 volt), only the receptacle with the larger kilowatt demand shall be required to be calculated.
- If the facility being installed includes individual kilowatt-hour submeters for each slip and is being calculated using the criteria listed in Table 555.12, the total demand amperes may be multiplied by 0.9 to achieve the final demand amperes.

NEC 2011

555.13 Wiring Methods and Installation

NEC Language

(B) Installation.

(1) **Overhead Wiring.** Overhead wiring shall be installed to avoid possible contact with masts and other parts of boats being moved in the yard.

Conductors and cables shall be routed to avoid wiring closer than 6.0 m (20 ft) from the outer edge or any portion of the yard that can be used for moving vessels or stepping or unstepping masts.

(2) **Outside Branch Circuits and Feeders.** Outside branch circuits and feeders shall comply with Article 225 except that clearances for overhead wiring in portions of the yard other than those described in 555.13(B)(1) shall not be less than 5.49 m (18 ft) abovegrade.

(3) **Wiring Over and Under Navigable Water.** Wiring over and under navigable water shall be subject to approval by the authority having jurisdiction.

Informational Note: See NFPA 303-2011, Fire Protection Standard for Marinas and Boatyards, for warning sign requirements.

(4) Portable Power Cables.

(a) Where portable power cables are permitted by 555.13(A)(2), the installation shall comply with the following:

(1) Cables shall be properly supported.

- (2) Cables shall be located on the underside of the pier.
- (3) Cables shall be securely fastened by nonmetallic clips to structural members other than the deck planking.
- (4) Cables shall not be installed where subject to physical damage.
- (5) Where cables pass through structural members, they shall be protected against chafing by a permanently installed oversized sleeve of nonmetallic material.

Changed From NEC 2008

555.13(B)(4)(b): This was revised to permit use of listed marine power outlet as splice location.

NEC Language

(b) Where portable power cables are used as permitted in 555.13(A)(2)(2), there shall be an approved junction box of corrosion-resistant construction with permanently installed terminal blocks on each pier section to which the feeder and feeder extensions are to be connected. A listed marine power outlet employing terminal blocks/bars shall be permitted in lieu of a junction box. Metal junction boxes and their covers, and metal screws and parts that are exposed externally to the boxes, shall be of corrosion-resistant materials or protected by material resistant to corrosion.

Changed From NEC 2008

555.13(B)(5) **Protection**: This was revised to specify nonmetallic conduit types.

NEC Language

(5) **Protection**. Rigid metal conduit, reinforced thermosetting resin conduit (RTRC) listed for aboveground use, or rigid polyvinyl chloride (PVC) conduit suitable for the location, shall be installed to protect wiring above decks of piers and landing stages and below the enclosure that it serves. The conduit shall be connected to the enclosure by full standard threads or fittings listed for use in damp or wet locations, as applicable.

ARTICLE 590 — Temporary Installations

There is a misconception that temporary wiring represents a lower standard than that of other wiring. In fact, it merely meets a different standard.

In one sense, however, a temporary installation does represent a lower standard. For example, you can use Type NM cable rather than raceway-enclosed wiring without any height limitations based on the type of construction, and it is not necessary to put splices in boxes. You must remove a temporary installation upon completion of the purpose for which it was installed. If the temporary installation is for holiday displays, it cannot last more than 90 days.

Article 590 addresses practicality and execution issues that are inherent in temporary installations, thereby making them less time consuming to install.

590.4 General

NEC Language

(A) **Services.** Services shall be installed in conformance with Parts I through VIII of Article 230, as applicable.

(B) **Feeders.** Overcurrent protection shall be provided in accordance with 240.4, 240.5, 240.100, and 240.101. Conductors shall be permitted within cable assemblies or within multiconductor cords or cables of a type identified in Table 400.4 for hard usage or extra-hard usage. For the purpose of this section, Type NM and Type NMC cables shall be permitted to be used in any dwelling, building, or structure without any height limitation or limitation by building construction type and without concealment within walls, floors, or ceilings.

Exception. Single insulated conductors shall be permitted where installed for the purpose(s) specified in 590.3(C), where accessible only to qualified persons.

Changed From NEC 2008

590.4(C) Branch Circuits: This was revised to include other locations where branch circuits originate.

NEC Language

(C) **Branch Circuits.** All branch circuits shall originate in an approved power outlet, switchboard or panelboard, motor control center, or fused switch enclosure. Conductors shall be permitted within cable assemblies or within multiconductor cord or cable of a type identified in Table 400.4 for hard usage or extra-hard usage. Conductors shall be protected from overcurrent as provided in 240.4, 240.5, and 240.100. For the purposes of this section, Type NM and Type NMC cables shall be permitted to be used in any dwelling, building, or structure without any height limitation or limitation by building construction type and without concealment within walls, floors, or ceilings.

Exception: Branch circuits installed for the purposes specified in 590.3(B) or 590.3(C) shall be permitted to be run as single insulated conductors. Where the wiring is installed in accordance with 590.3(B), the voltage to ground shall not exceed 150 volts, the wiring shall not be subject to physical damage, and the conductors shall be supported on insulators at intervals of not more than 3.0 m (10 ft); or, for festoon lighting, the conductors shall be so arranged that excessive strain is not transmitted to the lampholders.

(D) **Receptacles.**

Changed From NEC 2008

590.4(D)(1) All Receptacles: This was revised to prohibit receptacles from being supplied from any branch circuits that supplies temporary lighting.

NEC Language

(1) **All Receptacles.** All receptacles shall be of the grounding type. Unless installed in a continuous metal raceway that qualifies as an equipment grounding conductor in accordance with 250.118 or a continuous metal-covered cable that qualifies as an equipment grounding conductor in accordance with 250.118, all branch circuits shall include a separate equipment grounding conductor, and all receptacles shall be electrically connected to the equipment grounding conductor(s). Receptacles on construction sites shall not be installed on any branch circuit that supplies temporary lighting.

Changed From NEC 2008

590.4(D)(2) **Receptacles in Wet Locations:** The NEC added a new requirement referencing 406.9(B)(1) for receptacles installed in wet locations.

NEC Language

(2) **Receptacles in Wet Locations.** All 15- and 20-ampere, 125- and 250-volt receptacles installed in a wet location shall comply with 406.9(B)(1).

590.6 Ground-Fault Protection for Personnel**NEC Language**

Ground-fault protection for personnel for all temporary wiring installations shall be provided to comply with 590.6(A) and (B). This section shall apply only to temporary wiring installations used to supply temporary power to equipment used by personnel during construction, remodeling, maintenance, repair, or demolition of buildings, structures, equipment, or similar activities. This section shall apply to power derived from an electric utility company or from an on-site-generated power source.

Changed From NEC 2008

590.6(A) **Receptacle Outlets:** Revised and reorganized requirements for GFCI protection of receptacles used to supply temporary power.

NEC Language

(A) **Receptacle Outlets.** Temporary receptacle installations used to supply temporary power to equipment used by personnel during construction, remodeling, maintenance, repair, or demolition of buildings, structures, equipment, or similar activities shall comply with the requirements of 590.6(A)(1) through (A)(3), as applicable.

Exception: In industrial establishments only, where conditions of maintenance and supervision ensure that only qualified personnel are involved, an assured equipment grounding conductor program as specified in 590.6(B)(2) shall be permitted for only those receptacle outlets used to supply equipment that would create a greater hazard if power were interrupted or having a design that is not compatible with GFCI protection.

(1) **Receptacle Outlets Not Part of Permanent Wiring.** All 125-volt, single-phase, 15-, 20-, and 30-ampere receptacle outlets that are not a part of the

permanent wiring of the building or structure and that are in use by personnel shall have ground-fault circuit-interrupter protection for personnel.

(2) **Receptacle Outlets Existing or Installed as Permanent Wiring.** Ground-fault circuit-interrupter protection for personnel shall be provided for all 125-volt, single-phase, 15-, 20-, and 30-ampere receptacle outlets installed or existing as part of the permanent wiring of the building or structure and used for temporary electric power. Listed cord sets or devices incorporating listed ground-fault circuit-interrupter protection for personnel identified for portable use shall be permitted.

Changed From NEC 2008

590.6(A)(3) **Receptacles on 15-kW or less Portable Generators:** The NEC added a new requirement for GFCI protection of 125 volt and 125/250 volt, single phase, 15-, 20-, and 30-ampere receptacles installed on portable generators rated 15 kW and less. Requirement also specifies that receptacles used in a wet or damp location are to comply with 406.9(A) and (B).

NEC Language

(3) **Receptacles on 15-kW or less Portable Generators.** All 125-volt and 125/250-volt, single-phase, 15-, 20-, and 30-ampere receptacle outlets that are a part of a 15-kW or smaller portable generator shall have listed ground-fault circuit-interrupter protection for personnel. All 15- and 20-ampere, 125- and 250-volt receptacles, including those that are part of a portable generator, used in a damp or wet location shall comply with 406.9(A) and (B). Listed cord sets or devices incorporating listed ground-fault circuit-interrupter protection for personnel identified for portable use shall be permitted for use with 15-kW or less portable generators manufactured or remanufactured prior to January 1, 2011.

Changed From NEC 2008

590.6(B) **Use of Other Outlets:** This was revised to include specific uses for other receptacles supplying temporary power.

NEC Language

(B) **Use of Other Outlets.** For temporary wiring installations, receptacles, other than those covered by 590.6(A)(1) through (A)(3) used to supply temporary power to equipment used by personnel during construction, remodeling, maintenance, repair, or demolition of buildings, structures, or equipment, or similar activities, shall have protection in accordance with (B)(1) or the assured equipment grounding conductor program in accordance with (B)(2).

(1) **GFCI Protection.** Ground-fault circuit-interrupter protection for personnel.

Exam

1. 501.140 Flexible Cords, Class I, Divisions 1 and 2. (B)(4): In Division 1 locations or in Division 2 locations where the boxes, fittings, or enclosures are required to be explosionproof, the cord shall be terminated with _____.
 - a. a cord connector
 - b. an attachment plug listed for the location
 - c. a cord connector installed with a seal listed for the location
 - d. Any of the above
2. 504.30(B) From Different Intrinsically Safe Circuit Conductors: The clearance between two terminals for connection of field wiring of different intrinsically safe circuits shall be at least _____, unless this clearance is permitted to be reduced by the control drawing.
 - a. 0.15
 - b. 0.20
 - c. 0.25
 - d. 0.30
3. 511.3(C)(2)(a) Ventilation Provided: The ceiling area shall be unclassified where ventilation is provided, from a point not more than _____ from the highest point in the ceiling, to exhaust the ceiling area at a rate of not less than 0.3 m³/min/m² (1 cfm/ft²) of ceiling area at all times that the building is occupied or when vehicles using lighter-than-air gaseous fuels are parked below this area.
 - a. 12 inches
 - b. 18 inches
 - c. 20 inches
 - d. 24 inches
4. 590.4(C) Branch Circuits: What is the height limitation of NM or NMC cables permitted in a dwelling?
 - a. 4 feet
 - b. 8 feet
 - c. 10 feet
 - d. No height limitation
5. 555.3 Ground-Fault Protection. The main overcurrent protective device that feeds the marina shall have ground fault protection not exceeding _____. Ground-fault protection of each individual branch or feeder circuit shall be permitted as a suitable alternative.

- a. 150 mA
 - b. 100 mA
 - c. 90 mA
 - d. None of the above
6. 551.80(B) Protection Against Physical Damage: Where subject to physical damage, the conductors or cables shall be protected by rigid metal conduit, intermediate metal conduit, Schedule 80 PVC conduit, or RTRC listed for exposure to physical damage. All such protection shall extend at least _____ into the trench from finished grade.
- a. 14 in
 - b. 16 in
 - c. 18 in
 - d. 20 in
7. 551.47 (I) Wiring Methods. Cable Supports. Where connected with cable connectors or clamps, cables shall be supported within _____ of outlet boxes, distribution panelboards, and splice boxes on appliances. Supports shall be provided at intervals not exceeding 1.4 m (4½ ft) at other places.
- a. 6 inches
 - b. 10 inches
 - c. 12 inches
 - d. 14 inches
8. 551.47(I) Cable Supports: Where connected with cable connectors or clamps, cables shall be supported within 300 mm (12 in.) of outlet boxes, distribution panelboards, and splice boxes on appliances. Supports shall be provided at intervals not exceeding _____ at other places.
- a. 4 ½ feet
 - b. 3 feet
 - c. 3 ½ feet
 - d. 6 feet
9. 551.2. Low Voltage: An electromotive force shall be rated _____, nominal, or less.
- a. 12 volts
 - b. 16 volts
 - c. 24 volts
 - d. 50 volts

- 10.550.25 (B) Arc-Fault Circuit-Interrupter Protection. Mobile Homes and Manufactured Homes.** In which room(s) of mobile and manufactured homes are arc-fault circuit interrupters not required?
- Sunroom and dining rooms
 - Living rooms
 - Kitchen and bathrooms
 - Bedrooms
- 11. 550.13(F)(1):** Receptacles cannot be installed in relation to a _____ space.
- Toilet
 - Sink
 - Behind door
 - Over bathtub and shower
- 12.550.13(B) Ground-Fault Circuit Interrupters (GFCI):** GFCI protection shall be provided for receptacle outlets serving countertops in kitchens and receptacle outlets located within _____ of a wet bar sink. The exceptions in 210.8(A) shall be permitted.
- 6 feet
 - 4 feet
 - 3 feet
 - None of the above
- 13. 547.10(B) Bonding:** Equipotential planes shall be connected to the electrical grounding system. The bonding conductor shall be solid copper, insulated, covered or bare, and not smaller than _____.
- 4 AWG
 - 6 AWG
 - 8 AWG
 - 10 AWG
- 14.547.10(B) Bonding:** The means of bonding to wire mesh or conductive elements shall be by pressure connectors or clamps of _____.
- Brass
 - Copper
 - Copper alloy
 - Any of the above
- 15.547.8(C) Exposed to Water:** To be suitable for use in a wet location, Luminaires must be listed as resistant to exposure to _____.

- a. Water from condensation
 - b. Building cleansing water
 - c. Solution
 - d. All of the above
- 16.547.5 (G) Wiring Methods. Receptacles:** All 125-volt, single-phase, 15- and 20-ampere general-purpose receptacles installed _____ shall have ground-fault circuit-interrupter protection:
- a. Bedrooms
 - b. Outdoors
 - c. Halls
 - d. Living room
- 17.525.22 (A) Portable Distribution or Termination Boxes. Construction.** Portable distribution or termination boxes shall be designed so that no live parts are exposed except when necessary for examination, adjustment, servicing, or maintenance by qualified persons. Where installed outdoors, the box shall be of weatherproof construction and mounted so that the bottom of the enclosure is not less than _____ above the ground.
- a. 6 inches
 - b. 8 inches
 - c. 10 inches
 - d. None of the above
- 18.517.63 (A) Grounded Power Systems in Anesthetizing Locations - Battery-Powered Lighting Units.** One or more battery-powered lighting units shall be provided and shall be permitted to be wired to the critical lighting circuit in the area and connected _____.
- a. Ahead of any local switches
 - b. On the load side of the switch
 - c. None of the above
 - d. All of the above
- 19.517.18(B) Patient Bed Location Receptacles:** Each patient bed location shall be provided with a minimum of _____ receptacles.
- a. One
 - b. Two
 - c. Three
 - d. Four

- 20.515.7 (A) Wiring and Equipment Above Class I Locations - Fixed Wiring.** All fixed wiring above Class I locations shall be in metal raceways:
- Schedule 80 PVC conduit, Type RTRC marked with the suffix –XW
 - Type MI, Type TC, or Type MC cable
 - Type PLTC and Type PLTC-ER cable
 - All of the above
- 21.514.8 Underground Wiring - Exception No. 2:** Type PVC conduit and Type RTRC conduit shall be permitted where buried under not less than _____ of cover.
- 1 foot
 - 2 feet
 - 3 feet
 - 4 feet
- 22.506.2 Combustible Dust** is any finely divided solid material that is _____ or smaller in diameter (material passing a U.S. No. 40 Standard Sieve) and presents a fire or explosion hazard when dispersed and ignited in air.
[499:3.3.3]
- 420 microns
 - 440 microns
 - 460 microns
 - 480 microns
- 23.502.10(B)(1)(7):** In industrial establishments with restricted public access where the conditions of maintenance and supervision ensure that only qualified persons service the installation and where metallic conduit does not provide sufficient corrosion resistance, reinforced thermosetting resin conduit (RTRC) factory elbows, and associated fittings, all marked with suffix -XW, and Schedule _____ PVC conduit, factory elbows and associated fittings shall be permitted.
- 30
 - 40
 - 60
 - 80
- 24.502.10(B)(3)(3):** The NEC was revised to permit installation of nonincendive field wiring in raceways where conductor insulation thickness is not less than _____ in.
- 0.50
 - 0.01

- c. 0.60
 - d. 0.30
- 25.502.150(B)(1) Contacts:** Contacts shall comply with 502.150(A)(1) or shall be installed in enclosures that are _____ or otherwise identified for the location.
- a. Rainproof
 - b. Raitight
 - c. Dusttight
 - d. Dustproof
- 26.517.18(B) Patient Bed Location Receptacles:** Each patient bed location shall be provided with a minimum of four receptacles. They shall be permitted to be _____.
- a. Single type
 - b. Duplex type
 - c. Quadruplex type
 - d. Any combination of the three
- 27.517.19 (A) Critical Care Areas - Patient Bed Location Branch Circuits.** Each patient bed location shall be supplied by at least ____ branch circuits.
- a. two
 - b. three
 - c. four
 - d. six
- 28.525.5 Overhead Conductor Clearances - Over 600 Volts.** Portable structures shall not be located under or within a space that is located _____ horizontally and extending vertically to grade of conductors operating in excess of 600 volts.
- a. 3 feet
 - b. 6 feet
 - c. 15 feet
 - d. 12 feet
- 29.553.4 Location of Service Equipment.** The service equipment for a floating building shall be located adjacent to, but not in or on, the building or any floating structure. The main overcurrent protective device that feeds the floating structure shall have ground fault protection not exceeding _____. Ground fault protection of each individual branch or feeder circuit shall be permitted as a suitable alternative.
- a. 50 mA

- b. 80 mA
- c. 100 mA
- d. 120 mA

30.590.6(A)(3) Receptacles on 15-kW or less Portable Generators. Listed cord sets or devices incorporating listed ground-fault circuit-interrupter protection for personnel identified for portable use shall be permitted for use with _____ or less portable generators manufactured or remanufactured prior to January 1, 2011.

- a. 20-kW
- b. 15-kW
- c. 25 kW
- d. 30 kW

Attachment #2: Instructor Information

Course Instructor:

Joe Crump

Florida Certified Electrical Contractor AC# 2712320

Mr. Crump's resume is attached for review.

Joe H. Crump

1900 Winchester Road North, Saint Petersburg FL 33710
Home (727) 343-0713 Work (727) 224-8200

Experience

L. Crump Electric, Saint Petersburg, FL.

Owner, 1973-Present

Schedule and control up to 75 full time employees. Residential, commercial, and industrial appraiser.

U.S. Army Corp of Engineering, United States Army

Electrical Engineer, 1969-1972

Designed and implemented wiring for military bases. Supervised quality control.

Certification

1966 Journeyman Electrical Certified

1969 Master Electrician — City of Saint Petersburg, FL

1969 United States Civil Service — Skilled Electrician

1970 Department of the Army — Construction Foreman Course

1990 Master Electrician — State of Florida

1991 Southern Building Code Congress — Residential Electrical Inspector

1992 Southern Building Code Congress — Commercial Electrical Inspector

1992 Building Officials and Code Administrators International, Inc. — Certified as a Electrical Inspector

1992 Southern Building Code Congress — Certified as Electrical inspector

1992 Grounding and Bonding Certified

1992 National Certification Program — 1 & 2 Family Housing

1993 National Certification Program — Electrical General

1993 National Certification Program — Commercial

1993 Business Industry Training Institute, Northwest Iowa Community College — 1993 Florida Boards of Building Codes and Standards Certified

1996 NFPA Board Certified into the Electrical Section

1996 Teacher with Pinellas County Vocation Tech School

1996 National Certified as A Board Electrical Contractor

2008 — Florida Certified Electrical Contractor AC# 2712320

2008 — PCCLB License #I-EC 13002856

Education

Attended Florida Beacon College

Bachelor Degree from Rhodes College

MBA from Florida Metropolitan University

Attachment #3: Course Materials and Fees

Course Material:

The course is reviewed online and is available to anyone who purchases it 24/7 as long as there is computer and internet access.

All material necessary to complete the course is included by viewing online. Students are not directed to additional material as a requirement for course completion, only as added information for personal interest.

Course Fee:

The fee for this course is \$44.85

Attachment #4: Schedule of Course Dates and Locations

This course is presented in an online format. The course is available at www.RedVector.com 24 hours a day, 7 days a week to anyone with computer and internet access.

SAMPLE

Certificate of Completion

John Doe

VA License #: 123456

has successfully completed the following course

Series B: 2011 NEC Code Changes - Chapter 5 (RV-10289)

This online course is approved for 3 continuing education hours

XXXXXXXXXX

date of course completion

Course Approval

Course Completion Date

Matthew Casey, PhD, VP of Content

RedVector.com

AIA Registered Provider #J315

FL DBPR Approved Provider #0001771

FBPE Approved Provider #33



Two Urban Centre • 4890 West Kennedy Boulevard Suite 740 • Tampa, FL 33609

Attachment #6: Online/Correspondence Course Information

Security Procedures Utilized:

All students must register with the web site to gain access to their online course(s). The registration process creates a unique user profile and records their personal information including name, address, phone, email, username, password, licenses held, and license number(s). This information is automatically recorded and saved electronically.

We monitor required student participation in the course by logging and tracking the date and time a student enters a course, tracking activity during the course, and recording the date and time they complete the exam with a required passing score. If our learning management system detects 13-minutes of inactivity, a pop-up appears alerting the student that they must verify their presence or the session times out and the course closes.

In addition, at the completion of an exam, before it is graded, students are asked to confirm an affidavit indicating they personally completed the entire course. They must also confirm their identity before their exam is graded. This confirmation is stored in our database for audit purposes.

Once a student completes and passes the course with a grade of 70% or higher, they are given a certificate of completion and the course completion is recorded in their user profile, along with date and time completed.

End of Course Test:

A copy is attached for review.

Online Course Access:

The Board has been set up with a test account to preview courses on the RedVector.com website. To access the courses, please follow the directions below.

1. Log on to the web site at <http://www.RedVector.com>
2. On the top center of the page click the orange "Sign-In" button.
3. In the gray column labeled "Returning Users" enter your username **VAELEC** and your password **vaelec (both are case-sensitive)**. Click the "LOGIN" button.
4. You should arrive at the User Menu. Click on the second box "My Courses".
5. A list of courses will appear. Click on the title of the course you wish to begin and follow the instructions.

Exam: 2011 NEC Code Changes - Chapter 5 (4 hour)

1. 501.140 Flexible Cords, Class I, Divisions 1 and 2. (B)(4): In Division 1 locations or in Division 2 locations where the boxes, fittings, or enclosures are required to be explosionproof, the cord shall be terminated with _____.
 - A. a cord connector
 - B. an attachment plug listed for the location
 - C. a cord connector installed with a seal listed for the location
 - D. Any of the above

2. 504.30(B) From Different Intrinsically Safe Circuit Conductors: The clearance between two terminals for connection of field wiring of different intrinsically safe circuits shall be at least _____, unless this clearance is permitted to be reduced by the control drawing.
 - A. 0.15
 - B. 0.2
 - C. 0.25
 - D. 0.3

3. 511.3(C)(2)(a) Ventilation Provided: The ceiling area shall be unclassified where ventilation is provided, from a point not more than _____ from the highest point in the ceiling, to exhaust the ceiling area at a rate of not less than 0.3 m³/min/m² (1 cfm/ft²) of ceiling area at all times that the building is occupied or when vehicles using lighter-than-air gaseous fuels are parked below this area.
 - A. 12 inches
 - B. 18 inches
 - C. 20 inches
 - D. 24 inches

4. 590.4(C) Branch Circuits: What is the height limitation of NM or NMC cables permitted in a dwelling?
 - A. 4 feet
 - B. 8 feet
 - C. 10 feet
 - D. No height limitation

5. 555.3 Ground-Fault Protection. The main overcurrent protective device that feeds the marina shall have ground fault protection not exceeding _____. Ground-fault protection of each individual branch or feeder circuit shall be permitted as a suitable alternative.
 - A. 150 mA
 - B. 100 mA
 - C. 90 mA
 - D. None of the above

6. 551.80(B) Protection Against Physical Damage: Where subject to physical damage, the conductors or cables shall be protected by rigid metal conduit, intermediate metal conduit, Schedule 80 PVC conduit, or RTRC listed for exposure to physical damage. All such protection shall extend at least _____ into the trench from finished grade.
- A. 14 inches
 - B. 16 inches
 - C. 18 inches
 - D. 20 inches
7. 551.47 (I) Wiring Methods. Cable Supports. Where connected with cable connectors or clamps, cables shall be supported within _____ of outlet boxes, distribution panelboards, and splice boxes on appliances. Supports shall be provided at intervals not exceeding 1.4 m (4½ ft) at other places.
- A. 6 inches
 - B. 10 inches
 - C. 12 inches
 - D. 14 inches
8. 551.47(I) Cable Supports: Where connected with cable connectors or clamps, cables shall be supported within 300 mm (12 in.) of outlet boxes, distribution panelboards, and splice boxes on appliances. Supports shall be provided at intervals not exceeding _____ at other places.
- A. 4.5 feet
 - B. 3 feet
 - C. 3.5 feet
 - D. 6 feet
9. 551.2. Low Voltage: An electromotive force shall be rated _____, nominal, or less.
- A. 12 volts
 - B. 16 volts
 - C. 24 volts
 - D. 50 volts
10. 550.25 (B) Arc-Fault Circuit-Interrupter Protection. Mobile Homes and Manufactured Homes. In which room(s) of mobile and manufactured homes are arc-fault circuit interrupters not required?
- A. Sunroom and dining rooms
 - B. Living rooms
 - C. Kitchen and bathrooms
 - D. Bedrooms
11. 550.13(F)(1): Receptacles cannot be installed in relation to a _____ space.
- A. Toilet
 - B. Sink
 - C. Behind door
 - D. Over bathtub and shower

12. 550.13(B) Ground-Fault Circuit Interrupters (GFCI): GFCI protection shall be provided for receptacle outlets serving countertops in kitchens and receptacle outlets located within _____ of a wet bar sink. The exceptions in 210.8(A) shall be permitted.
- A. 6 feet
 - B. 4 feet
 - C. 3 feet
 - D. None of the above
13. 547.10(B) Bonding: Equipotential planes shall be connected to the electrical grounding system. The bonding conductor shall be solid copper, insulated, covered or bare, and not smaller than _____.
- A. 4 AWG
 - B. 6 AWG
 - C. 8 AWG
 - D. 10 AWG
14. 547.10(B) Bonding: The means of bonding to wire mesh or conductive elements shall be by pressure connectors or clamps of _____.
- A. Brass
 - B. Copper
 - C. Copper alloy
 - D. Any of the above
15. 547.8(C) Exposed to Water: To be suitable for use in a wet location. Luminaires must be listed as resistant to exposure to _____.
- A. Water from condensation
 - B. Building cleansing water
 - C. Solution
 - D. All of the above
16. 547.5 (G) Wiring Methods. Receptacles: All 125-volt, single-phase, 15- and 20-ampere general-purpose receptacles installed _____ shall have ground-fault circuit-interrupter protection:
- A. Bedrooms
 - B. Outdoors
 - C. Halls
 - D. Living room
17. 525.22 (A) Portable Distribution or Termination Boxes. Construction. Portable distribution or termination boxes shall be designed so that no live parts are exposed except when necessary for examination, adjustment, servicing, or maintenance by qualified persons. Where installed outdoors, the box shall be of weatherproof construction and mounted so that the bottom of the enclosure is not less than _____ above the ground.
- A. 6 inches
 - B. 8 inches
 - C. 10 inches

D. None of the above

18. 517.63 (A) Grounded Power Systems in Anesthetizing Locations - Battery-Powered Lighting Units. One or more battery-powered lighting units shall be provided and shall be permitted to be wired to the critical lighting circuit in the area and connected _____.
- A. Ahead of any local switches
 - B. On the load side of the switch
 - C. None of the above
 - D. All of the above
19. 517.18(B) Patient Bed Location Receptacles: Each patient bed location shall be provided with a minimum of _____ receptacles.
- A. One
 - B. Two
 - C. Three
 - D. Four
20. 515.7 (A) Wiring and Equipment Above Class I Locations - Fixed Wiring. All fixed wiring above Class I locations shall be in metal raceways:
- A. Schedule 80 PVC conduit, Type RTRC marked with the suffix -XW
 - B. Type MI, Type TC, or Type MC cable
 - C. Type PLTC and Type PLTC-ER cable
 - D. All of the above
21. 514.8 Underground Wiring - Exception No. 2: Type PVC conduit and Type RTRC conduit shall be permitted where buried under not less than _____ of cover.
- A. 1 foot
 - B. 2 feet
 - C. 3 feet
 - D. 4 feet
22. 506.2 Combustible Dust is any finely divided solid material that is _____ or smaller in diameter (material passing a U.S. No. 40 Standard Sieve) and presents a fire or explosion hazard when dispersed and ignited in air. [499:3.3.3]
- A. 420 microns
 - B. 440 microns
 - C. 460 microns
 - D. 480 microns
23. 502.10(B)(1)(7): In industrial establishments with restricted public access where the conditions of maintenance and supervision ensure that only qualified persons service the installation and where metallic conduit does not provide sufficient corrosion resistance, reinforced thermosetting resin conduit (RTRC) factory elbows, and associated fittings, all marked with suffix -XW, and Schedule _____ PVC conduit, factory elbows and associated fittings shall be permitted.
- A. 30

- B. 40
- C. 60
- D. 80

24. 502.10(B)(3)(3): The NEC was revised to permit installation of nonincendive field wiring in raceways where conductor insulation thickness is not less than ____ in.
- A. 0.5
 - B. 0.01
 - C. 0.6
 - D. 0.3
25. 502.150(B)(1) Contacts: Contacts shall comply with 502.150(A)(1) or shall be installed in enclosures that are _____ or otherwise identified for the location.
- A. Rainproof
 - B. Raitight
 - C. Dusttight
 - D. Dustproof
26. 517.18(B) Patient Bed Location Receptacles: Each patient bed location shall be provided with receptacles. They shall be permitted to be _____.
- A. Single type
 - B. Duplex type
 - C. Quadruplex type
 - D. Any combination of the three
27. 517.19 (A) Critical Care Areas - Patient Bed Location Branch Circuits. Each patient bed location shall be supplied by at least ____ branch circuits.
- A. two
 - B. three
 - C. four
 - D. six
28. 525.5 Overhead Conductor Clearances - Over 600 Volts. Portable structures shall not be located under or within a space that is located _____ horizontally and extending vertically to grade of conductors operating in excess of 600 volts.
- A. 3 feet
 - B. 6 feet
 - C. 15 feet
 - D. 12 feet
29. 553.4 Location of Service Equipment. The service equipment for a floating building shall be located adjacent to, but not in or on, the building or any floating structure. The main overcurrent protective device that feeds the floating structure shall have ground fault protection not exceeding 100 mA. Ground fault protection of each individual branch or feeder circuit shall be permitted as a suitable alternative.

- A. 50 mA
- B. 80 mA
- C. 100 mA
- D. 120 mA

30. 590.6(A)(3) Receptacles on 15-kW or less Portable Generators. Listed cord sets or devices incorporating listed ground-fault circuit-interrupter protection for personnel identified for portable use shall be permitted for use with _____ or less portable generators manufactured or remanufactured prior to January 1, 2011.
- A. 20-kW
 - B. 15-kW
 - C. 25 kW
 - D. 30 kW

Attachment #1: Course Syllabus

Course Title:

Series B: 2011 NEC Code Changes - Introduction, Chapter 1 & Chapter 2 (RV-10286)

Course Hours:

3 hours

Course Instructor:

Joe Crump

Course Description:

The NFPA® updates to the NEC Code periodically – you need to know the latest updates and the reasons for them.

This **interactive online** course provides you with everything you need to be familiar with the NEC Code – specifically the 2011 version. For all of the major Code changes covered, you'll get:

- A summary addressing each relevant Change.
- Excerpts of actual 2011 National Electrical Code® text with relevant Staff comments and illustrations.
- First-time articles, usability improvements, and revisions that boost electrical safety making the 2011 National Electrical Code® essential.

Course Objectives:

At the conclusion of this course, you will be able to:

- Discuss the scope of the 2011 National Electric Code
- Explain code-wide changes
- Recognize the reasons for changes to existing Code
- List new articles in the Code
- Describe deletions in some existing requirements

Course Outline:

Introduction

Ch. 1 Article 100 Definitions

Ch. 1 Articles 110.3 – 110.74

- Article 110 — Requirements for Electrical Installations
- 110.3 — Examination, Identification, Installation, and Use of Equipment
- 110.10 Circuit Impedance, Short-Circuit Current Ratings, and Other Characteristics
- 110.11 Deteriorating Agents
- 110.14 Electrical Connections
- 110.16 Arc-Flash Hazard Warning
- 110.22 Identification of Disconnecting Means
- 110.24 Available Fault Current
- 110.26 Spaces About Electrical Equipment
- 110.28 Enclosure Types.
- 110.31 Enclosure for Electrical Installations
- 110.34 Work Space and Guarding
- 110.74 Conductor Installation

Ch. 2 Articles 200.2 – 200.7

- Article 200 — Use and Identification of Grounded Conductors
- 200.2 General
- 200.4 Neutral Conductors
- 200.6 Means of Identifying Grounded Conductors.
- 200.7 — Use of Insulation of a White or Gray Color or with Three Continuous White Stripes

Ch. 2 Articles 210.4 – 210.52

- Article 210 — Branch Circuits
- 210.4 Multiwire Branch Circuits
- 210.5 Identification for Branch Circuits
- 210.6 Branch-Circuit Voltage Limitations
- 210.7 Multiple Branch Circuits
- 210.8 — Ground-Fault Circuit-Interrupter — Protection for Personnel
- 210.12 Arc-Fault Circuit-Interrupter Protection
- 210.19 Conductors — Minimum Ampacity and Size
- 210.24 Branch-Circuit Requirements — Summary
- 210.52 Dwelling Unit Receptacle Outlets
- 210.52[G] – Basements, Garages, and Accessory Buildings

Ch. 2 Articles 220.5 – 225.70

- 220.5 Calculations
- 220.14 Other Loads — All Occupancies
- 220.18 Maximum Loads
- 220.43 Show-Window and Track Lighting
- 220.86 Schools
- 220.102 Farm Loads — Buildings and Other Loads
- Article 225 — Outside Branch Circuits and Feeders
- 225.2 Definition
- 225.8 Calculation of Loads 600 Volts, Nominal, or Less
- 225.18 Clearance for Overhead Conductors and Cables
- 225.22 Raceways on Exterior Surfaces of Buildings or Other Structures
- 225.27 Raceway Seal
- 225.30 Number of Supplies
- 225.52 Disconnecting Means
- 225.56 Inspections and Tests
- 225.70 Substations

Ch. 2 Articles 230.6 – 230.208

- Article 230 — Services
- 230.6 Conductors Considered Outside the Building
- 230.24 Clearances
- 230.32 Protection Against Damage
- 230.40 Number of Service-Entrance Conductor Sets
- 230.42 Minimum Size and Rating
- 230.43 Wiring Methods for 600 Volts, Nominal, or Less
- 230.44 Cable Trays
- 230.50 Protection Against Physical Damage
- 230.54 Overhead Service Locations

- 230.66 Marking
- 230.72 Grouping of Disconnects
- 230.77 Indicating
- 230.82 Equipment Connected to the Supply Side of Service Disconnect
- 230.92 Locked Service Overcurrent Devices
- 230.205 Disconnecting Means
- 230.208 Protection Requirements

Ch. 2 Articles 240.4 – 240.91

- 240.4 Protection of Conductors
- 240.15 Ungrounded Conductors (Overcurrent Protection)
- 240.21 Location in Circuit
- 240.24 Location in or on Premises
- 240.87 Noninstantaneous Trip
- 240.91 Protection of Conductors

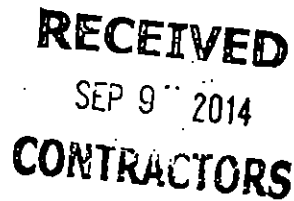

2011 NEC® Code Changes – Introduction, Chapter 1 and Chapter 2

Developed by National Green Building, Inc.

Course Description

The NFPA updates to the NEC Code periodically – you need to know the latest updates and the reasons for them.

This **interactive online** course provides you with everything you need to be familiar with the NEC Code – specifically the 2011 version. For all of the major Code changes covered, you'll get:



Eden Electrical

- A summary addressing each relevant Change.
- Excerpts of actual 2011 National Electrical Code text with relevant Staff comments and illustrations.
- First-time articles, usability improvements, and revisions that boost electrical safety making the 2008 National Electrical Code essential.

Performance Objectives

At the conclusion of this course, you will be able to:

- Discuss the scope of the 2011 National Electric Code
- Explain code-wide changes
- Recognize the reasons for changes to existing Code
- List new articles in the Code
- Describe deletions in some existing requirements

References

1. NFPA. 2011 National Electric Code (NEC), 2010
2. NFPA. NEC Plus, 2010
3. International Association of Electrical Inspectors. NEC 2011 — Analysis of Changes, 2010.
4. Mike Holt Enterprises. Changes to the NEC 2011, 2010

The designations “National Electric Code” and “NEC” refer to NFPA 70, National Electric Code, which is a registered trademark of the National Fire Protection Association.

Note: The National Electric Code is intended for electricians and subcontractors, electrical inspectors, electrical engineers, designers, and other qualified persons who understand electrical currents, theory, safety procedures, and electrical trade practices. The code does not serve as a teaching manual for untrained individuals.

To properly use this course, you must use a hard copy of the 2011 NEC. You will need it for reference while taking the course, especially when reviewing information in large tables.

You are encouraged to obtain either the electronic version or the printed hard copy of the 2011 NEC, the National Electrical Code Report on Proposals and the National Electrical Code Report on Comments. These valuable resources include a more detailed record of each change and provide actual panel actions and statements to help clarify the changes that were accepted.

A **Summary of each change** (highlighted in yellow) is provided when additional discussion is required. Generally, for each highlighted change, the course covers the provisions of the change and in most cases, the actual **NEC Language** needed for elaboration or clarification.

When necessary, the course paraphrases appropriate paragraphs to illustrate precise NEC wording or terminology. In many cases, paragraphs not directly affected by a change are retained to preserve context.

Introduction

According to the National Fire Protection Association (NFPA), there were approximately 5,077 proposals submitted for modifications to the 2011 edition of the NEC. Of these proposals, 4,093 were submitted by the public at large, while 174 proposals were developed by the code-making panels themselves during the proposal stage.

As with every edition of the NEC, some of the changes include new requirements to sections, while some of the changes include entirely new articles. Some changes are revisions to existing requirements while others are deletions to some existing requirements.

Code-Wide Changes

90.5(C) Mandatory Rules, Permissive Rules, and Explanatory Material

90.5(D) Informative Annexes

The familiar term **fine print notes (FPN)** has been removed throughout the Code and replaced with **Informational Notes**. “Fine print” refers to a type size, rather than clearly portraying its advisory nature.

The NEC contains notes that are enforceable requirements of the code, such as **table notes**. “Fine print” in some legal documents does not necessarily make the text an unenforceable requirement. This change makes the advisory nature of these notes clear.

Also, a new section has been added at 90.5(D) introducing the concept of **Informative Annexes** to the NEC.

Non-mandatory information relative to the use of the NEC is contained in the informative annexes found in the back of the NEC. Informative annexes are not part of the enforceable requirements of the NEC, but are included for information purposes only.

Alternative Energy

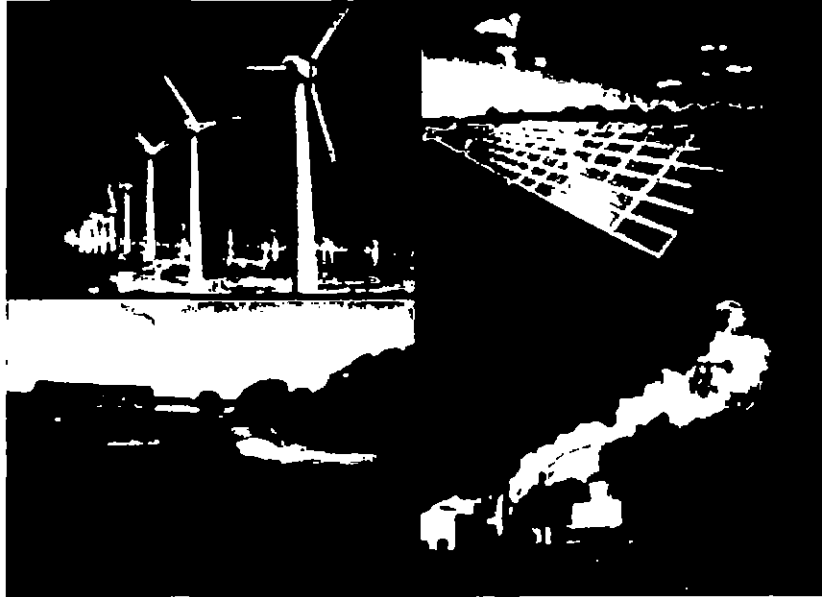

GreenGop.org

Major changes to the 2011 NEC focus on **alternative energy**. The Code now recognizes the increasing demand for alternate energy, and provides safe installation requirements.

Coverage of solar, fuel cell, and green technology is not new for the NEC. These latest changes in the 2011 edition update the Code by reflecting field experience and current technology.

The 2011 Code has revised **Article 625** to include **plug-in-hybrid vehicle charging systems** as equipment that must meet the electrical protection and ventilation requirements of Article 625. In the future, plug-in hybrid vehicles may not only serve as a source of transportation, they may also be able to serve as a power source.

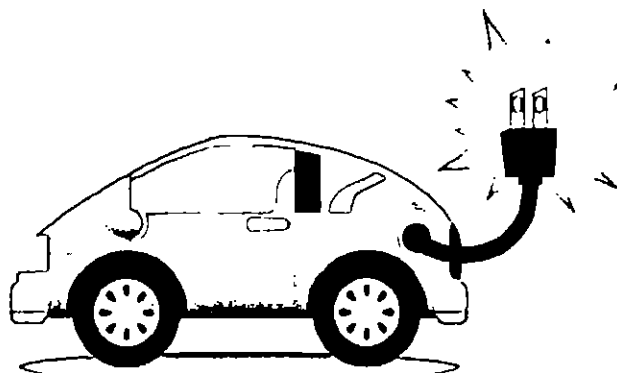

Solar Home

Article 705 is a key article in alternative energy system requirements for **systems that interface with a utility source**. It covers interconnecting generators, wind turbines, and

solar and fuel cells with utility and other power sources. NEC made a number of editorial changes to improve its usefulness.



Fairway Electric & Solar Energy

Another change to the 2011 NEC is the addition of new **Article 694**, which provides new requirements for the installation of **small wind electric systems**. This new article also covers requirements for individual generators that are limited to 100 kW or less. Multiple wind turbines can be used in accordance with this article, as long as no single turbine exceeds 100 kW. This article is patterned in format after **Article 690** for photovoltaic systems.



GreenSafeguard.com

Article **840** has been added to address the increased demand for **broadband communications systems** with requirements for premises-powered optical fiber-based broadband communications systems. These systems provide a wide array of services, including voice, video, data (such as Internet access), and interactive services through an optical network terminal. Article 840 contains requirements for wiring both the inside and the outside of buildings for these types of systems.

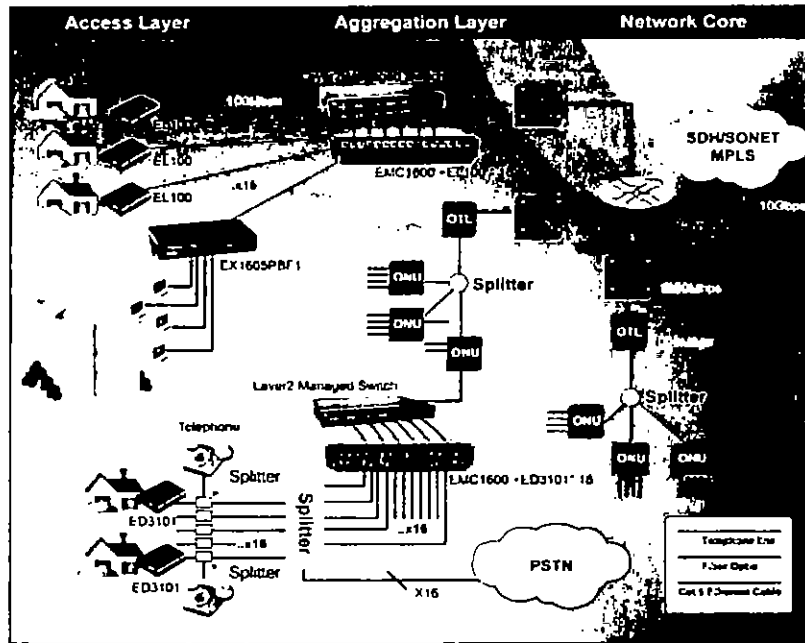

InterConnect Network & Software Design

A new **Article 399** provides requirements for **overhead distribution systems of large electrical systems** that are common on commercial and industrial campuses. The requirements in this new article cover electrical installations over 600 volts.



IAEI Magazine

Medium voltage switchgear (motor control center)

In addition to these changes, the 2011 edition of the Code has also added several new requirements on issues relating to workplace safety that dovetail requirements in NFPA 70E®, Standard for Electrical Safety in the Workplace®. For instance, in 240.87, it added a new requirement that documents the use of circuit breakers without an instantaneous trip and, where they are used, to provide means to reduce incident energy.

The Code also has added a new requirement in 408.4(B) that it be clearly marked where a power source originates on switchboards and panel boards that are supplied by a feeder. Another new requirement in 450.14 clarifies disconnecting means for transformers by covering disconnecting means for transformers other than Class 2 or Class 3 transformers.

Along with these major changes, there were many minor revisions made in the 2011 NEC in an effort to clarify requirements, improve readability, and enhance usability. All of these changes—both major and minor—strive to keep the NEC an important and

ever-changing document. This new 2011 edition sets a new benchmark for safe electrical design, installation, and inspection.

Other Changes

Other changes include definitions:

- Revisions of **grounding** and **bonding** definitions.
The term **grounding conductor** was replaced with the term **grounding electrode conductor, bonding jumper, or bonding conductor** in several places throughout the NEC.
- New definitions for **branch-circuit overcurrent devices, surge arrestors, surge protective devices (SPDs)**.
- Revisions of the terms **neutral conductor** and **neutral point**.

ARTICLE 90

Although there are no significant changes to Article 90 in the 2011 NEC, we start with this article because it contains special arrangements for communications installations.

Section 90.2 — Scope states that the NEC "covers the installation of electrical conductors, equipment, and raceways; signaling and communications conductors, equipment, and raceways; and optical fiber cables and raceways" in "Public and private premises, including buildings, structures, mobile homes, recreational vehicles, and floating buildings." It also states the "Code does not cover" "Installations of communications equipment under the exclusive control of communications utilities located outdoors or in building spaces used exclusively for such installations".

Section 90.3 — Code Arrangement states that "Chapters 1, 2, 3, and 4 apply generally" and that "Chapter 8 covers communications systems and is not subject to the requirements of Chapters 1 through 7 except where the requirements are specifically referenced in Chapter 8." Section 90.2 also states that "Chapters 5, 6, and 7 apply to special occupancies, special equipment, or other special conditions. These latter chapters supplement or modify the general rules."

What is the significance of these requirements? The NEC covers communications equipment, wires and cables installed in most buildings; it includes optical fiber cables and raceways too. However, it exempts telephone company central offices because it has an exemption for communications utility installations under the exclusive control of the utility. It does not exempt telephone switching offices run by a nonutility such as a large university or a nonutility provider of telephone service.

Chapter 8 — Communications Systems. The communications chapter of the NEC is independent of the rest of the code; only those electrical wiring requirements in Chapters 1 through 7 that are referenced in Chapter 8 apply to Chapter 8. One example is that the cable tray fill requirements in Article 392 (Cable Trays) do not apply to installations of communications cables covered by Chapter 8. They do apply to installations of data cables (class 2 cables) because these are in Article 725. They don't apply to optical fiber cables because the cable tray fill requirements are written apply to electrical cables only.

Data wiring (class 2 wiring) is covered by Article 725 and some computer room installations are covered by Article 645. These Articles modify the general wiring rules in Chapters 1 through 4; however they are not permitted to modify the wiring rules for

communications installations without a reference from Chapter 8; this is significant for installations of communications equipment in a computer room where Article 645 is applied to the IT equipment but not the communications equipment.

90.2 — Scope

The 2011 NEC (Code) covers:

- The installation of electrical conductors, equipment, and raceways
- Signaling and communications conductors
- Equipment, and raceways; and
- Optical fiber cables and raceways for the following:
 - (1) Public and private premises, including buildings, structures, mobile homes, recreational vehicles, and floating buildings
 - (2) Yards, lots, parking lots, carnivals, and industrial substations
 - (3) Installations of conductors and equipment that connect to the supply of electricity
 - (4) Installations used by the electric utility, such as office buildings, warehouses, garages, machine shops, and recreational buildings, that are not an integral part of a generating plant, substation, or control center.

The Code does not cover the following:

(1) Installations in ships, watercraft other than floating buildings, railway rolling stock, aircraft, or automotive vehicles other than mobile homes and recreational vehicles

Informational Note: Although the scope of this Code indicates that the Code does not cover installations in ships, portions of this Code are incorporated by reference into Title 46, Code of Federal Regulations, Parts 110–113.

(2) Installations underground in mines and self-propelled mobile surface mining machinery and its attendant electrical trailing cable

(3) Installations of railways for generation, transformation, transmission, or distribution of power used exclusively for operation of rolling stock or installations used exclusively for signaling and communications purposes

(4) Installations of communications equipment under the exclusive control of communications utilities located outdoors or in building spaces used exclusively for such installations

(5) Installations under the exclusive control of an electric utility where such installations

- a. Consist of service drops or service laterals, and associated metering, or
- b. Are on property owned or leased by the electric utility for the purpose of communications, metering, generation, control, transformation, transmission, or distribution of electric energy, or

Changed From NEC 2008

90.2(b)(5)(c): Section 90.2(B)(5) was revised to clarify which utility installations are outside the scope of the NEC.

The NEC added new text to specify what types of installations can be included under other electrical agreements.

NEC Language

- c. Are located in legally established easements or rights-of-way, or
- d. Are located by other written agreements either designated by or recognized by public service commissions, utility commissions, or other regulatory agencies having jurisdiction for such installations. These written agreements shall be limited to installations for the purpose of communications, metering, generation, control, transformation, transmission, or distribution of electric energy where legally established easements or rights-of-way cannot be obtained. These installations shall be limited to federal lands, native American reservations through the U.S. Department of the Interior Bureau of Indian Affairs, military bases, lands controlled by port authorities and state agencies and departments, and lands owned by railroads.

Informational Note to (4) and (5): Examples of utilities may include those entities that are typically designated or recognized by governmental law or regulation by public service/utility commissions and that install, operate, and maintain electric supply (such as generation, transmission, or distribution systems) or communications systems (such as telephone, CATV, Internet, satellite, or data services). Utilities may be subject to compliance with codes and standards covering their regulated activities as adopted under governmental law or regulation. Additional information can be found through consultation with the appropriate governmental bodies, such as state regulatory commissions, the Federal Energy Regulatory Commission, and the Federal Communications Commission.

Changed From NEC 2008

90.2(C) Special Permission: Section 90.2(C) was revised to clarify that the conductors and equipment that can be exempted by special permission are those that connect to the service conductors. This also clarifies that the exempted conductors may extend into a building or structure to the nearest point of entrance of the service conductors.

NEC Language

(C) Special Permission. The authority having jurisdiction for enforcing this Code may grant exception for the installation of conductors and equipment that are not under the exclusive control of the electric utilities and are used to connect the electric utility supply system to the service conductors of the premises served, provided such installations are outside a building or structure, or terminate inside nearest the point of entrance of the service conductors.

90.5 — Mandatory Rules, Permissive Rules, and Explanatory Material

(A) Mandatory Rules. Mandatory rules of this Code are those that identify actions that are specifically required or prohibited and are characterized by the use of the terms shall or shall not.

(B) Permissive Rules. Permissive rules of this Code are those that identify actions that are allowed but not required, are normally used to describe options or alternative methods, and are characterized by the use of the terms shall be permitted or shall not be required.

Changed From NEC 2008

90.5(C): Section 90.5(C) **Explanatory Material** was revised by changing FPNs to informational notes.

Explanatory material will now be provided in informational notes.

NEC Language

(C) **Explanatory Material.** Explanatory material, such as references to other standards, references to related sections of this Code, or information related to a Code rule, is included in this Code in the form of informational notes. Such notes are informational only and are not enforceable as requirements of this Code.

Brackets containing section references to another NFPA document are for informational purposes only and are provided as a guide to indicate the source of the extracted text. These bracketed references immediately follow the extracted text.

Informational Note: The format and language used in this Code follows guidelines established by NFPA and published in the NEC Style Manual. Copies of this manual can be obtained from NFPA.

Changed From NEC 2008

90.5(D) **Informative Annexes:** A new section indicates that non-mandatory information in the NEC is found in the informative annexes and that information provided in an informative annex is not enforceable.

NEC Language

(D) **Informative Annexes.** Nonmandatory information relative to the use of the NEC is provided in informative annexes. Informative annexes are not part of the enforceable requirements of the NEC, but are included for information purposes only.

Highlight

While most of the Code changes apply specifically to certain Articles or Sections, some changes have been made that affect the entire NEC. For example, the term fine print notes (FPN) has been removed throughout the Code. This term has been replaced with Informational Notes.

The term "Fine print" refers to a type size, rather than clearly portraying its advisory nature.

The NEC contains notes that are enforceable requirements of the code, such as table notes.

"Fine print" in some legal documents does not necessarily make the text unenforceable requirements. This change makes the advisory nature of these notes clear.

Also, a new section has been added at 90.5(D) introducing the concept of Informative Annexes to the NEC. Non-mandatory information relative to the use of the NEC is provided in the informative annexes found in the back of the NEC. Informative annexes are not part of the enforceable requirements of the NEC, but are included for information purposes only.

Many standards in addition to the NEC contain normative and informative annexes. Normative annexes are requirements and informative annexes are not. With this new trend in standards, this change clarifies the nature of the annexes and their definitions.

Chapter 1 — General

Article 100 — Definitions

This chapter defines the terms used in the Code so you can understand and apply them. It is very worthwhile to review this entire list of terms, whether changed or not, because they are used throughout the document.

We will now review the full list of NEC 2011 definitions.

A yellow background highlights the definitions that changed in NEC 2011.

Accessible (as applied to equipment). Admitting close approach; not guarded by locked doors, elevation, or other effective means.

Accessible (as applied to wiring methods). Capable of being removed or exposed without damaging the building structure or finish or not permanently closed in by the structure or finish of the building.

Accessible, Readily (Readily Accessible). Capable of being reached quickly for operation, renewal, or inspections without requiring those to whom ready access is requisite to climb over or remove obstacles or to resort to portable ladders, and so forth.

Changed From NEC 2008

Ampacity. This was revised to indicate it is the maximum current that can be carried continuously.

The revised definition makes clear that the current by which a conductor can carry continuously under the conditions for use without exceeding its temperature rating, is the maximum current, not just any current. By inserting "maximum" in the definition, the Code indicates that this is the maximum current that a conductor can carry before any adjustments or correction factors are applied. The previous definition was not specific, and not as clear as it would be with the word "maximum" added. Any current less than the maximum can also be carried "continuously under the conditions of use without exceeding its temperature rating." Of course, most experience users

NEC Language

Ampacity. The maximum current, in amperes, that a conductor can carry continuously under the conditions of use without exceeding its temperature rating.

This definition implies the maximum, but this was not clear to all users, thus necessitating this clarification.

Appliance. Utilization equipment, generally other than industrial, that is normally built in standardized sizes or types and is installed or connected as a unit to perform one or more functions such as clothes washing, air conditioning, food mixing, deep frying, and so forth.

Approved. Acceptable to the authority having jurisdiction.

Changed From NEC 2008

Arc-Fault Circuit Interrupter (AFCI). This was relocated from Article 210 to Article 100.

NEC Language

Arc-Fault Circuit Interrupter (AFCI). A device intended to provide protection from the effects of arc faults by recognizing characteristics unique to arcing and by functioning to de-energize the circuit when an arc fault is detected.

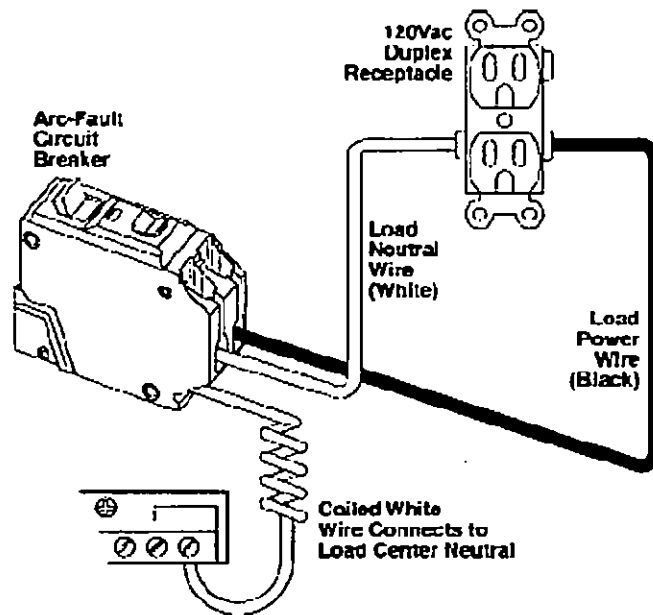

Inspectapedia

Highlight

This definition of an AFCI is not new to the NEC but it was moved from Section 210.12 in order to follow the guidance of the NEC Style Manual. The NEC Style Manual is the guidance document used by the NEC Panels to prepare the Code in a structured and consistent format. It states that if more than two articles contain the same terms, then the definition of that term shall be included in the **definitions** section of the NEC.

Since the term Arc-Fault Circuit Interrupter is used in four other Articles, it was moved to satisfy this guideline.

Askarel. A generic term for a group of nonflammable synthetic chlorinated hydrocarbons used as electrical insulating media. Askarels of various compositional types are used. Under arcing conditions, the gases produced, while consisting predominantly of noncombustible hydrogen chloride, can include varying amounts of combustible gases, depending on the askarel type.

Attachment Plug (Plug Cap) (Plug). A device that, by insertion in a receptacle, establishes a connection between the conductors of the attached flexible cord and the conductors connected permanently to the receptacle.

Authority Having Jurisdiction (AHJ). An organization, office, or individual responsible for enforcing the requirements of a code or standard, or for approving equipment, materials, an installation, or a procedure.

Informational Note: The phrase "authority having jurisdiction," or its acronym AHJ, is used in NFPA documents in a broad manner, since jurisdictions and approval agencies vary, as do their responsibilities. Where public safety is primary, the authority having jurisdiction may be a federal, state, local, or other regional department or individual such as a fire chief; fire marshal; chief of a fire prevention bureau, labor department, or health department; building official; electrical inspector; or others having statutory authority. For insurance purposes, an insurance inspection department, rating bureau, or other insurance company representative may be the

authority having jurisdiction. In many circumstances, the property owner or his or her designated agent assumes the role of the authority having jurisdiction; at government installations, the commanding officer or departmental official may be the authority having jurisdiction.

Automatic. Performing a function without the necessity of human intervention.

Changed From NEC 2008

Bathroom was expanded by adding additional plumbing fixtures that, in combination with a basin, constitute a bathroom.

The previous definition was too restrictive, because it did not include various items that constitute a bathroom. This change covers other items, such as urinals. The revised definition is also important for the compliance of installers and code enforcement with other code requirements, such as receptacle placement requirements at basins, and for luminaire and ceiling fan requirements in bathrooms.

NEC Language

Bathroom. An area including a basin with one or more of the following: a toilet, a urinal, a tub, a shower, a bidet, or similar plumbing fixtures.



Home Design Inspiration

Bonded (Bonding). Connected to establish electrical continuity and conductivity.

Changed From NEC 2008

Bonding Conductor or Jumper The word "conductor" was added to correlate with use of the terms, "bonding jumper" and "bonding conductor" in Article 250 and other places in the code.

NEC Language

Bonding Conductor or Jumper. A reliable conductor to ensure the required electrical conductivity between metal parts required to be electrically connected.

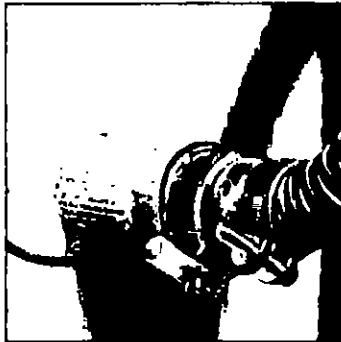

IAEI Magazine

Bonding Jumper, Equipment. The connection between two or more portions of the equipment grounding conductor.

Bonding Jumper, Main. The connection between the grounded circuit conductor and the equipment grounding conductor at the service.

Changed From NEC 2008

Bonding Jumper, System. Relocated from Article 250 and revised to clarify the function of the bonding jumper by adding a reference to the supply-side bonding jumper.

This definition was revised and moved to Article 100 from 250.2. This was done because this term is used in more places than Article 250.

The change correctly uses the new term supply-side bonding jumper and includes additional permitted or required connections. In addition, the revised definition identifies the function of the system bonding jumper as related to the equipment grounding conductor.

NEC Language

Bonding Jumper, System. The connection between the grounded circuit conductor and the supply-side bonding jumper, or the equipment grounding conductor, or both, at a separately derived system.

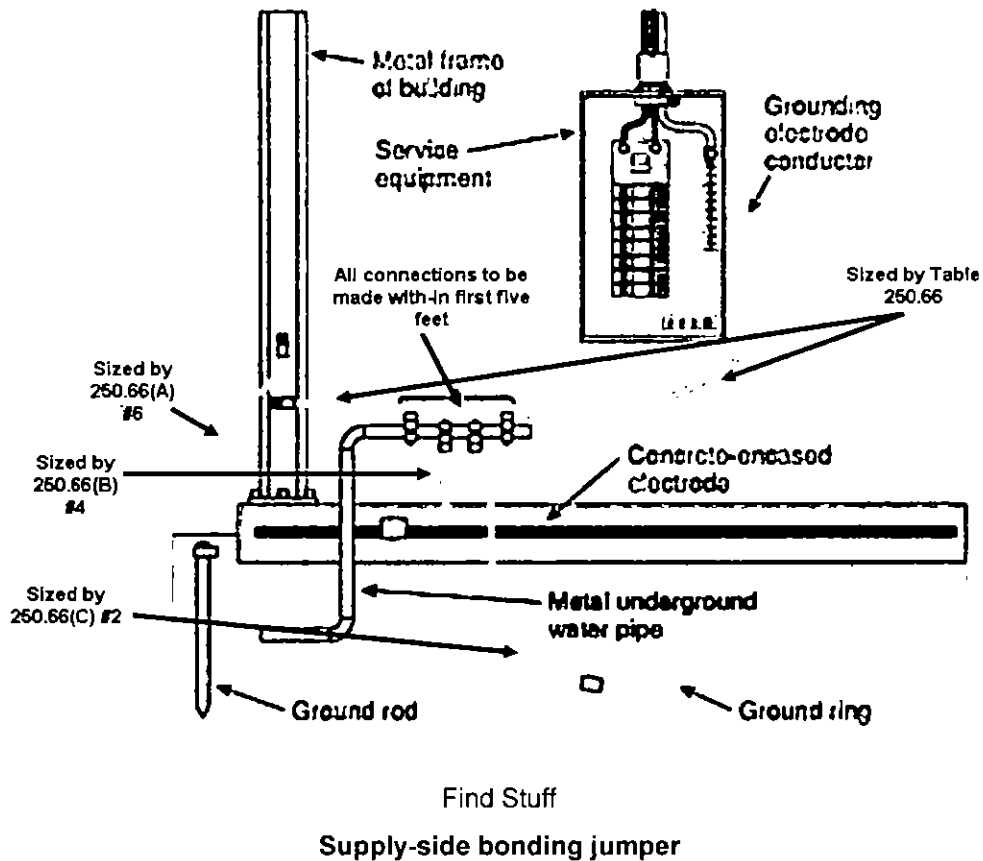

Branch Circuit. The circuit conductors between the final overcurrent device protecting the circuit and the outlet(s).

Branch Circuit, Appliance. A branch circuit that supplies energy to one or more outlets to which appliances are to be connected and that has no permanently connected luminaires that are not a part of an appliance.

Branch Circuit, General-Purpose. A branch circuit that supplies two or more receptacles or outlets for lighting and appliances.

Branch Circuit, Individual. A branch circuit that supplies only one utilization equipment.

Branch Circuit, Multiwire. A branch circuit that consists of two or more ungrounded conductors that have a voltage between them, and a grounded conductor that has equal voltage between it and each ungrounded conductor of the circuit and that is connected to the neutral or grounded conductor of the system.

Building. A structure that stands alone or that is cut off from adjoining structures by fire walls with all openings therein protected by approved fire doors.

Cabinet. An enclosure that is designed for either surface mounting or flush mounting and is provided with a frame, mat, or trim in which a swinging door or doors are or can be hung.

Circuit Breaker. A device designed to open and close a circuit by nonautomatic means and to open the circuit automatically on a predetermined overcurrent without damage to itself when properly applied within its rating.

Informational Note: The automatic opening means can be integral, direct acting with the circuit breaker, or remote from the circuit breaker.

Adjustable (as applied to circuit breakers). A qualifying term indicating that the circuit breaker can be set to trip at various values of current, time, or both, within a predetermined range.

Instantaneous Trip (as applied to circuit breakers). A qualifying term indicating that no delay is purposely introduced in the tripping action of the circuit breaker.

Inverse Time (as applied to circuit breakers). A qualifying term indicating that there is purposely introduced a delay in the tripping action of the circuit breaker, which delay decreases as the magnitude of the current increases.

Nonadjustable (as applied to circuit breakers). A qualifying term indicating that the circuit breaker does not have any adjustment to alter the value of current at which it will trip or the time required for its operation.

Setting (of circuit breakers). The value of current, time, or both, at which an adjustable circuit breaker is set to trip.

Clothes Closet. A non-habitable room or space intended primarily for storage of garments and apparel.

Communications Equipment. The electronic equipment that performs the telecommunications operations for the transmission of audio, video, and data, and includes power equipment (e.g., dc converters, inverters, and batteries) and technical support equipment (e.g., computers).

Concealed. Rendered inaccessible by the structure or finish of the building. Wires in concealed raceways are considered concealed, even though they may become accessible by withdrawing them.

Conductor, Bare. A conductor having no covering or electrical insulation whatsoever.

Conductor, Covered. A conductor encased within material of composition or thickness that is not recognized by this Code as electrical insulation.

Conductor, Insulated. A conductor encased within material of composition and thickness that is recognized by this Code as electrical insulation.

Conduit Body. A separate portion of a conduit or tubing system that provides access through a removable cover(s) to the interior of the system at a junction of two or more sections of the system or at a terminal point of the system.

Boxes such as FS and FD or larger cast or sheet metal boxes are not classified as conduit bodies.

Connector, Pressure (Solderless). A device that establishes a connection between two or more conductors or between one or more conductors and a terminal by means of mechanical pressure and without the use of solder.

Continuous Load. A load where the maximum current is expected to continue for 3 hours or more.

Controller. A device or group of devices that serves to govern, in some predetermined manner, the electric power delivered to the apparatus to which it is connected.

Cooking Unit, Counter-Mounted. A cooking appliance designed for mounting in or on a counter and consisting of one or more heating elements, internal wiring, and built-in or mountable controls.

Coordination (Selective). Localization of an overcurrent condition to restrict outages to the circuit or equipment affected, accomplished by the choice of overcurrent protective devices and their ratings or settings.

Copper-Clad Aluminum Conductors. Conductors drawn from a copper-clad aluminum rod with the copper metallurgically bonded to an aluminum core. The copper forms a minimum of 10 percent of the cross-sectional area of a solid conductor or each strand of a stranded conductor.

Cutout Box. An enclosure designed for surface mounting that has swinging doors or covers secured directly to and telescoping with the walls of the box proper.

Dead Front. Without live parts exposed to a person on the operating side of the equipment.

Demand Factor. The ratio of the maximum demand of a system, or part of a system, to the total connected load of a system or the part of the system under consideration.

Device. A unit of an electrical system that carries or controls electric energy as its principal function.

Disconnecting Means. A device, or group of devices, or other means by which the conductors of a circuit can be disconnected from their source of supply.

Dusttight. Constructed so that dust will not enter the enclosing case under specified test conditions.

Duty, Continuous. Operation at a substantially constant load for an indefinitely long time.

Duty, Intermittent. Operation for alternate intervals of (1) load and no load; or (2) load and rest; or (3) load, no load, and rest.

Duty, Periodic. Intermittent operation in which the load conditions are regularly recurrent.

Duty, Short-Time. Operation at a substantially constant load for a short and definite, specified time.

Duty, Varying. Operation at loads, and for intervals of time, both of which may be subject to wide variation.

Dwelling, One-Family. A building that consists solely of one dwelling unit.

Dwelling, Two-Family. A building that consists solely of two dwelling units.

Dwelling, Multifamily. A building that contains three or more dwelling units.

Dwelling Unit. A single unit, providing complete and independent living facilities for one or more persons, including permanent provisions for living, sleeping, cooking, and sanitation.

Electric Sign. A fixed, stationary, or portable self-contained, electrically illuminated utilization equipment with words or symbols designed to convey information or attract attention.

Electric Power Production and Distribution Network. Power production, distribution, and utilization equipment and facilities, such as electric utility systems that deliver electric power to the connected loads, that are external to and not controlled by an interactive system.

Enclosed. Surrounded by a case, housing, fence, or wall(s) that prevents persons from accidentally contacting energized parts.

Enclosure. The case or housing of apparatus, or the fence or walls surrounding an installation to prevent personnel from accidentally contacting energized parts or to protect the equipment from physical damage.

Informational Note: See Table 110.28 for examples of enclosure types.

Energized. Electrically connected to, or is, a source of voltage.

Equipment. A general term, including fittings, devices, appliances, luminaires, apparatus, machinery, and the like used as a part of, or in connection with, an electrical installation.

Changed From NEC 2008

Explosionproof Equipment. This was revised by replacing the term “apparatus” with “equipment” in the title and text.

NEC Language

Explosionproof Equipment. Equipment enclosed in a case that is capable of withstanding an explosion of a specified gas or vapor that may occur within it and of preventing the ignition of a specified gas or vapor surrounding the enclosure by sparks, flashes, or explosion of the gas or vapor within, and that operates at such an external temperature that a surrounding flammable atmosphere will not be ignited thereby.

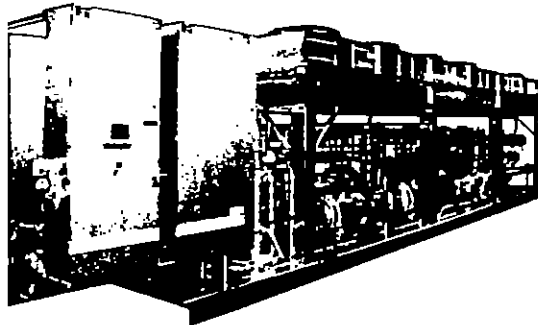

Berg Chilling Systems

Explosion Proof Process Chilling / Cooling / Refrigeration and Pumping / Mixing Equipment

Informational Note: For further information, see ANSI/UL 1203-2006, Explosion-Proof and Dust-Ignition-Proof Electrical Equipment for Use in Hazardous (Classified) Locations.

Exposed (as applied to live parts). Capable of being inadvertently touched or approached nearer than a safe distance by a person. It is applied to parts that are not suitably guarded, isolated, or insulated.

Exposed (as applied to wiring methods). On or attached to the surface or behind panels designed to allow access.

Externally Operable. Capable of being operated without exposing the operator to contact with live parts.

Feeder. All circuit conductors between the service equipment, the source of a separately derived system, or other power supply source and the final branch-circuit overcurrent device.

Festoon Lighting. A string of outdoor lights that is suspended between two points.

Fitting. An accessory such as a locknut, bushing, or other part of a wiring system that is intended primarily to perform a mechanical rather than an electrical function.

Garage. A building or portion of a building in which one or more self-propelled vehicles can be kept for use, sale, storage, rental, repair, exhibition, or demonstration purposes.

Informational Note: For commercial garages, repair and storage, see Article 511.

Ground. The earth.

Changed From NEC 2008

Ground Fault. This definition is relocated to Article 100

NEC Language

Ground Fault. An unintentional, electrically conducting connection between an ungrounded conductor of an electrical circuit and the normally non-current-carrying conductors, metallic enclosures, metallic raceways, metallic equipment, or earth.

Grounded (Grounding). Connected (connecting) to ground or to a conductive body that extends the ground connection.

Grounded, Solidly. Connected to ground without inserting any resistor or impedance device.

Grounded Conductor. A system or circuit conductor that is intentionally grounded.

Ground-Fault Circuit Interrupter (GFCI). A device intended for the protection of personnel that functions to de-energize a circuit or portion thereof within an established period of time when a current to ground exceeds the values established for a Class A device.

Informational Note: Class A ground-fault circuit interrupters trip when the current to ground is 6 mA or higher and do not trip when the current to ground is less than 4 mA. For further information, see UL 943, Standard for Ground-Fault Circuit Interrupters.

Ground Fault. An unintentional, electrically conducting connection between an ungrounded conductor of an electrical circuit and the normally non-current-carrying conductors, metallic enclosures, metallic raceways, metallic equipment, or earth.

Ground-Fault Protection of Equipment. A system intended to provide protection of equipment from damaging line-to-ground fault currents by operating to cause a disconnecting means to open all ungrounded conductors of the faulted circuit. This protection is provided at current levels less than those required to protect conductors from damage through the operation of a supply circuit overcurrent device.

Changed From NEC 2008

~~**Grounding Conductor.** A conductor used to connect equipment or the grounded circuit of a wiring system to a grounding electrode or electrodes.~~

Grounding Conductor This term was deleted from Article 100. These conductors were referred to a "grounding conductors" in Chapter 8 of previous editions of the Code. More appropriate terms are now used. The definition and use of the terms grounding electrode conductor and ground conductor were previously virtually the same and unnecessary, leading to inconsistency in the application and enforcement of these terms.

Grounding Conductor, Equipment (EGC). The conductive path(s) installed to connect normally non-current-carrying metal parts of equipment together and to the system grounded conductor or to the grounding electrode conductor, or both.

Informational Note No. 1: It is recognized that the equipment grounding conductor also performs bonding.

Informational Note No. 2: See 250.118 for a list of acceptable equipment grounding conductors.

Grounding Electrode. A conducting object through which a direct connection to earth is established.

Grounding Electrode Conductor. A conductor used to connect the system grounded conductor or the equipment to a grounding electrode or to a point on the grounding electrode system.

Guarded. Covered, shielded, fenced, enclosed, or otherwise protected by means of suitable covers, casings, barriers, rails, screens, mats, or platforms to remove the likelihood of approach or contact by persons or objects to a point of danger.

Guest Room. An accommodation combining living, sleeping, sanitary, and storage facilities within a compartment.

Guest Suite. An accommodation with two or more contiguous rooms comprising a compartment, with or without doors between such rooms, that provides living, sleeping, sanitary, and storage facilities.

Handhole Enclosure. An enclosure for use in underground systems, provided with an open or closed bottom, and sized to allow personnel to reach into, but not enter, for the purpose of installing, operating, or maintaining equipment or wiring or both.

Hoistway. Any shaftway, hatchway, well hole, or other vertical opening or space in which an elevator or dumbwaiter is designed to operate.

Identified (as applied to equipment). Recognizable as suitable for the specific purpose, function, use, environment, application, and so forth, where described in a particular Code requirement.

Informational Note: Some examples of ways to determine suitability of equipment for a specific purpose, environment, or application include investigations by a qualified testing laboratory (listing and labeling), an inspection agency, or other organizations concerned with product evaluation.

In Sight From (Within Sight From, Within Sight). Where this Code specifies that one equipment shall be "in sight from," "within sight from," or "within sight of," and so forth, another equipment, the specified equipment is to be visible and not more than 15 m (50 ft) distant from the other.

Interactive System. An electric power production system that is operating in parallel with and capable of delivering energy to an electric primary source supply system.

Changed From NEC 2008

Interrupting Rating. This is revised by replacing "intended" with "identified."
--

NEC Language

Interrupting Rating. The highest current at rated voltage that a device is identified to interrupt under standard test conditions.

Informational Note: Equipment intended to interrupt current at other than fault levels may have its interrupting rating implied in other ratings, such as horsepower or locked rotor current.

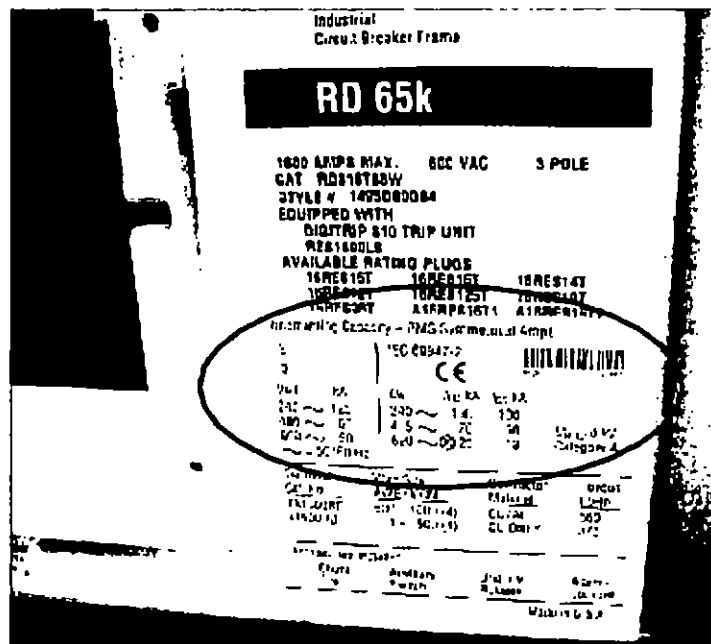

NEC Plus

Interrupting ratings information on the label of a 1600 ampere circuit breaker

Changed From NEC 2008

Intersystem Bonding Termination. This was revised to clarify that it is used to connect bonding conductors of the communications system to the grounding electrode system.

NEC Language

Intersystem Bonding Termination. A device that provides a means for connecting bonding conductors for communications systems to the grounding electrode system.

Isolated (as applied to location). Not readily accessible to persons unless special means for access are used.

Changed From NEC 2008

Kitchen. The definition is revised by replacing “facilities” with “provisions.”

NEC Language

Kitchen. An area with a sink and permanent provisions for food preparation and cooking.

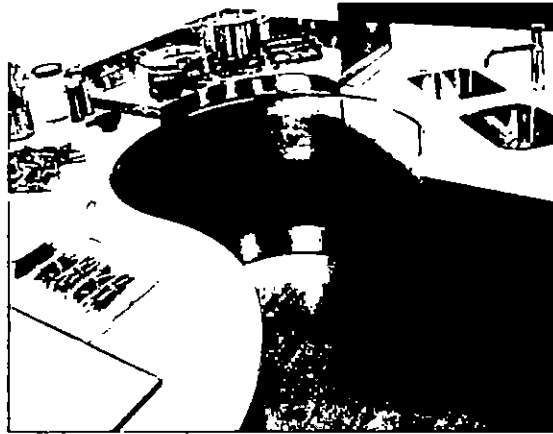

Kitchen Ideas.com

Labeled. Equipment or materials to which has been attached a label, symbol, or other identifying mark of an organization that is acceptable to the authority having jurisdiction and concerned with product evaluation, that maintains periodic inspection of production of labeled equipment or materials, and by whose labeling the manufacturer indicates compliance with appropriate standards or performance in a specified manner.

Lighting Outlet. An outlet intended for the direct connection of a lampholder or luminaire.

Listed. Equipment, materials, or services included in a list published by an organization that is acceptable to the authority having jurisdiction and concerned with evaluation of products or services, that maintains periodic inspection of production of listed equipment or materials or periodic evaluation of services, and whose listing states that either the equipment, material, or service meets appropriate designated standards or has been tested and found suitable for a specified purpose.

Informational Note: The means for identifying listed equipment may vary for each organization concerned with product evaluation, some of which do not recognize equipment as listed unless it is also labeled. Use of the system employed by the listing organization allows the authority having jurisdiction to identify a listed product.

Live Parts. Energized conductive components.

Location, Damp. Locations protected from weather and not subject to saturation with water or other liquids but subject to moderate degrees of moisture. Examples of such locations include partially protected locations under canopies, marquees, roofed open porches, and like locations, and interior locations subject to moderate degrees of moisture, such as some basements, some barns, and some cold-storage warehouses.

Location, Dry. A location not normally subject to dampness or wetness. A location classified as dry may be temporarily subject to dampness or wetness, as in the case of a building under construction.

Location, Wet. Installations underground or in concrete slabs or masonry in direct contact with the earth; in locations subject to saturation with water or other liquids, such as vehicle washing areas; and in unprotected locations exposed to weather.

Luminaire. A complete lighting unit consisting of a light source such as a lamp or lamps, together with the parts designed to position the light source and connect it to the power supply. It may also include parts to protect the light source or the ballast or to distribute the light. A lampholder itself is not a luminaire.

Metal-Enclosed Power Switchgear. A switchgear assembly completely enclosed on all sides and top with sheet metal (except for ventilating openings and inspection windows) and containing primary power circuit switching, interrupting devices, or both, with buses and connections. The assembly may include control and auxiliary devices. Access to the interior of the enclosure is provided by doors, removable covers, or both. Metal-enclosed power switchgear is available in non-arc-resistant or arc-resistant constructions.

Motor Control Center. An assembly of one or more enclosed sections having a common power bus and principally containing motor control units.

Multioutlet Assembly. A type of surface, flush, or freestanding raceway designed to hold conductors and receptacles, assembled in the field or at the factory.

Neutral Conductor. The conductor connected to the neutral point of a system that is intended to carry current under normal conditions.

Neutral Point. The common point on a wye-connection in a polyphase system or midpoint on a single-phase, 3-wire system, or midpoint of a single-phase portion of a 3-phase delta system, or a midpoint of a 3-wire, direct-current system.

Informational Note: At the neutral point of the system, the vectorial sum of the nominal voltages from all other phases within the system that utilize the neutral, with respect to the neutral point, is zero potential.

Changed From NEC 2008

Nonautomatic. The definition is revised to correlate with the definition of the term "automatic."

NEC Language

Nonautomatic. Requiring human intervention to perform a function.

Nonlinear Load. A load where the wave shape of the steady-state current does not follow the wave shape of the applied voltage.

Informational Note: Electronic equipment, electronic/electric-discharge lighting, adjustable-speed drive systems, and similar equipment may be nonlinear loads.

Outlet. A point on the wiring system at which current is taken to supply utilization equipment.

Outline Lighting. An arrangement of incandescent lamps, electric-discharge lighting, or other electrically powered light sources to outline or call attention to certain features such as the shape of a building or the decoration of a window.

Overcurrent. Any current in excess of the rated current of equipment or the ampacity of a conductor. It may result from overload, short circuit, or ground fault.

Informational Note: A current in excess of rating may be accommodated by certain equipment and conductors for a given set of conditions. Therefore, the rules for overcurrent protection are specific for particular situations.

Changed From NEC 2008

Overcurrent Protective Device, Branch-Circuit. This is editorially revised for usability. As a result of the revision, the definitions related to overcurrent protection are located in the same part of Article 100.

NEC Language

Overcurrent Protective Device, Branch-Circuit. A device capable of providing protection for service, feeder, and branch circuits and equipment over the full range of overcurrents between its rated current and its interrupting rating. Branch-circuit overcurrent protective devices are provided with interrupting ratings appropriate for the intended use but no less than 5000 amperes.

Changed From NEC 2008

Overcurrent Protective Device, Supplementary. This was editorially revised for usability. As a result of the revision, the definitions relative to overcurrent protection is located in the same part of Article 100.

NEC Language

Overcurrent Protective Device, Supplementary. A device intended to provide limited overcurrent protection for specific applications and utilization equipment such as luminaires and appliances. This limited protection is in addition to the protection provided in the required branch circuit by the branch-circuit overcurrent protective device.

Overload. Operation of equipment in excess of normal, full-load rating, or of a conductor in excess of rated ampacity that, when it persists for a sufficient length of time, would cause damage or dangerous overheating. A fault, such as a short circuit or ground fault, is not an overload.

Panelboard. A single panel or group of panel units designed for assembly in the form of a single panel, including buses and automatic overcurrent devices, and equipped with or without switches for the control of light, heat, or power circuits; designed to be placed in a cabinet or cutout box placed in or against a wall, partition, or other support; and accessible only from the front.

Plenum. A compartment or chamber to which one or more air ducts are connected and that forms part of the air distribution system.

Power Outlet. An enclosed assembly that may include receptacles, circuit breakers, fuseholders, fused switches, buses, and watt-hour meter mounting means; intended to supply and control power to mobile homes, recreational vehicles, park trailers, or boats or to serve as a means for distributing power required to operate mobile or temporarily installed equipment.

Premises Wiring (System). Interior and exterior wiring, including power, lighting, control, and signal circuit wiring together with all their associated hardware, fittings, and wiring devices, both permanently and temporarily installed. This includes (a) wiring from the service point or power source to the outlets or (b) wiring from and including the power source to the outlets where there is no service point.

Such wiring does not include wiring internal to appliances, luminaires, motors, controllers, motor control centers, and similar equipment.

Qualified Person. One who has skills and knowledge related to the construction and operation of the electrical equipment and installations and has received safety training to recognize and avoid the hazards involved.

Informational Note: Refer to NFPA 70E-2009, Standard for Electrical Safety in the Workplace, for electrical safety training requirements.

Raceway. An enclosed channel of metal or nonmetallic materials designed expressly for holding wires, cables, or busbars, with additional functions as permitted in this Code. Raceways include, but are not limited to, rigid metal conduit, rigid nonmetallic conduit, intermediate metal conduit, liquidtight flexible conduit, flexible metallic tubing, flexible metal conduit, electrical nonmetallic tubing, electrical metallic tubing, underfloor raceways, cellular concrete floor raceways, cellular metal floor raceways, surface raceways, wireways, and busways.

Rainproof. Constructed, protected, or treated so as to prevent rain from interfering with the successful operation of the apparatus under specified test conditions.

Raintight. Constructed or protected so that exposure to a beating rain will not result in the entrance of water under specified test conditions.

Receptacle. A receptacle is a contact device installed at the outlet for the connection of an attachment plug. A single receptacle is a single contact device with no other contact device on the same yoke. A multiple receptacle is two or more contact devices on the same yoke.

Receptacle Outlet. An outlet where one or more receptacles are installed.

Remote-Control Circuit. Any electrical circuit that controls any other circuit through a relay or an equivalent device.

Sealable Equipment. Equipment enclosed in a case or cabinet that is provided with a means of sealing or locking so that live parts cannot be made accessible without opening the enclosure. The equipment may or may not be operable without opening the enclosure.

Changed From NEC 2008

Separately Derived System. This was revised to clarify that a separately derived system may have some incidental connections to other systems, such as through metal raceways, equipment grounding conductors, or the earth.

NEC Language

Separately Derived System. A premises wiring system whose power is derived from a source of electric energy or equipment other than a service. Such systems have no direct connection from circuit conductors of one system to circuit conductors of another system, other than connections through the earth, metal enclosures, metallic raceways, or equipment grounding conductors.

Service. The conductors and equipment for delivering electric energy from the serving utility to the wiring system of the premises served.

Service Cable. Service conductors made up in the form of a cable.

Service Conductors. The conductors from the service point to the service disconnecting means.

Changed From NEC 2008

Service Conductors, Overhead. The NEC added a new term for what was formerly known as **service-drop conductors**. This term distinguishes overhead service conductors that are part of the premises wiring system from the overhead conductors that are on the line side of the service point.

NEC Language

Service Conductors, Overhead. The overhead conductors between the service point and the first point of connection to the service-entrance conductors at the building or other structure.

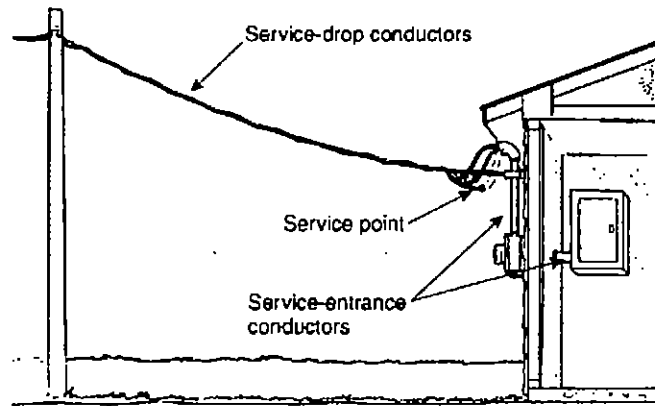

Technical Studies

Changed From NEC 2008

Service Conductors, Underground. The NEC added a new term for what was formerly known as **service-lateral conductors**. This is revised so that the definition more clearly describes the beginning and ending points of underground service conductors. The term distinguishes underground service conductors that are part of the premises wiring system from the underground service conductors that are on the line side of the service point. An informational note has been added following the revised definition to specify the point of connection where there is no terminal box, meter, or other enclosure.

NEC Language

Service Conductors, Underground. The underground conductors between the service point and the first point of connection to the service-entrance conductors in a terminal box, meter, or other enclosure, inside or outside the building wall.

Informational Note: Where there is no terminal box, meter, or other enclosure, the point of connection is considered to be the point of entrance of the service conductors into the building.

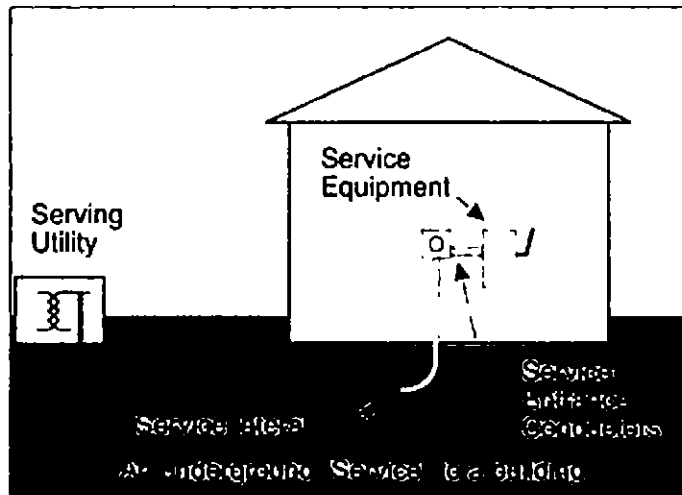
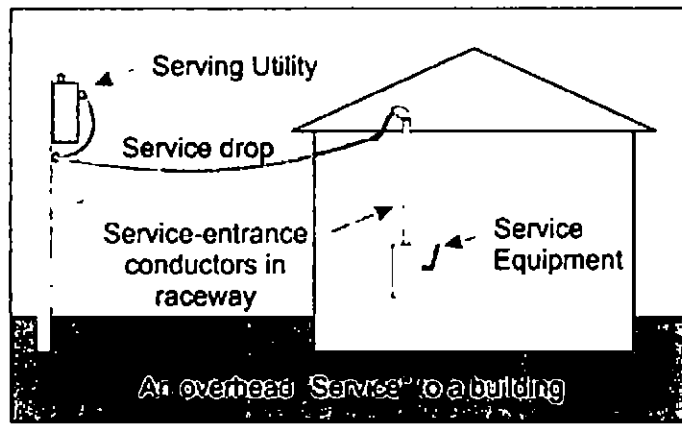

IAEI Magazine

An overhead service to a building and an underground service to another

Changed From NEC 2008

Service Drop. The revised term now applies only to overhead conductors that are on the line side of the service point.

NEC Language

Service Drop. The overhead conductors between the utility electric supply system and the service point.

Changed From NEC 2008

Service-Entrance Conductors, Overhead System. This was revised to correlate with the changes made to the definitions of "service drop" and "service lateral conductors."

NEC Language

Service-Entrance Conductors, Overhead System. The service conductors between the terminals of the service equipment and a point usually outside the building, clear of building walls, where joined by tap or splice to the service drop or overhead service conductors.

Changed From NEC 2008

Service-Entrance Conductors, Underground System. This was revised to correlate with the changes made to the definitions of "service drop" and "service lateral."

NEC Language

Service-Entrance Conductors, Underground System. The service conductors between the terminals of the service equipment and the point of connection to the service lateral or underground service conductors.

Informational Note: Where service equipment is located outside the building walls, there may be no service-entrance conductors or they may be entirely outside the building.

Service Equipment. The necessary equipment, usually consisting of a circuit breaker(s) or switch(es) and fuse(s) and their accessories, connected to the load end of service conductors to a building or other structure, or an otherwise designated area, and intended to constitute the main control and cutoff of the supply.

Changed From NEC 2008

Service Lateral. This was revised to clarify that these conductors are under the exclusive control of the utility company. Term now applies only to underground conductors that are on the line side of the service point.

NEC Language

Service Lateral. The underground conductors between the utility electric supply system and the service point.

Changed From NEC 2008

Service Point. The NEC added an "Informational Note" to provide additional information on the line of demarcation between the conductors of the serving utility and the premises wiring.

NEC Language

Service Point. The point of connection between the facilities of the serving utility and the premises wiring.

Informational Note: The service point can be described as the point of demarcation between where the serving utility ends and the premises wiring begins. The serving utility generally specifies the location of the service point based on the conditions of service.

Short-Circuit Current Rating. The prospective symmetrical fault current at a nominal voltage to which an apparatus or system is able to be connected without sustaining damage exceeding defined acceptance criteria.

Show Window. Any window used or designed to be used for the display of goods or advertising material, whether it is fully or partly enclosed or entirely open at the rear and whether or not it has a platform raised higher than the street floor level.

Signaling Circuit. Any electrical circuit that energizes signaling equipment.

Solar Photovoltaic System. The total components and subsystems that, in combination, convert solar energy into electric energy suitable for connection to a utilization load.

Special Permission. The written consent of the authority having jurisdiction.

Structure. That which is built or constructed.

Surge Arrester. A protective device for limiting surge voltages by discharging or bypassing surge current; it also prevents continued flow of follow current while remaining capable of repeating these functions.

Surge-Protective Device (SPD). A protective device for limiting transient voltages by diverting or limiting surge current; it also prevents continued flow of follow current while remaining capable of repeating these functions and is designated as follows:

Type 1: Permanently connected SPDs intended for installation between the secondary of the service transformer and the line side of the service disconnect overcurrent device.

Type 2: Permanently connected SPDs intended for installation on the load side of the service disconnect overcurrent device, including SPDs located at the branch panel.

Type 3: Point of utilization SPDs.

Type 4: Component SPDs, including discrete components, as well as assemblies.

Informational Note: For further information on Type 1, Type 2, Type 3, and Type 4 SPDs, see UL 1449, Standard for Surge Protective Devices.

Switch, Bypass Isolation. A manually operated device used in conjunction with a transfer switch to provide a means of directly connecting load conductors to a power source and of disconnecting the transfer switch.

Switch, General-Use. A switch intended for use in general distribution and branch circuits. It is rated in amperes, and it is capable of interrupting its rated current at its rated voltage.

Switch, General-Use Snap. A form of general-use switch constructed so that it can be installed in device boxes or on box covers, or otherwise used in conjunction with wiring systems recognized by this Code.

Switch, Isolating. A switch intended for isolating an electrical circuit from the source of power. It has no interrupting rating, and it is intended to be operated only after the circuit has been opened by some other means.

Switch, Motor-Circuit. A switch rated in horsepower that is capable of interrupting the maximum operating overload current of a motor of the same horsepower rating as the switch at the rated voltage.

Switch, Transfer. An automatic or nonautomatic device for transferring one or more load conductor connections from one power source to another.

Switchboard. A large single panel, frame, or assembly of panels on which are mounted on the face, back, or both, switches, overcurrent and other protective devices, buses, and usually instruments. Switchboards are generally accessible from the rear as well as from the front and are not intended to be installed in cabinets.

Thermal Protector (as applied to motors). A protective device for assembly as an integral part of a motor or motor-compressor that, when properly applied, protects the motor against dangerous overheating due to overload and failure to start.

Informational Note: The thermal protector may consist of one or more sensing elements integral with the motor or motor-compressor and an external control device.

Thermally Protected (as applied to motors). The words Thermally Protected appearing on the nameplate of a motor or motor-compressor indicate that the motor is provided with a thermal protector.

Ungrounded. Not connected to ground or to a conductive body that extends the ground connection.

Changed From NEC 2008

Uninterruptible Power Supply. This was added to describe the function of an uninterruptible power supply.

NEC Language

Uninterruptible Power Supply. A power supply used to provide alternating current power to a load for some period of time in the event of a power failure.

Informational Note: In addition, it may provide a more constant voltage and frequency supply to the load, reducing the effects of voltage and frequency variations.

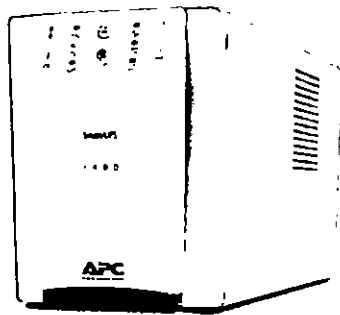

APC

Utility-Interactive Inverter. An inverter intended for use in parallel with an electric utility to supply common loads that may deliver power to the utility.

Utilization Equipment. Equipment that utilizes electric energy for electronic, electromechanical, chemical, heating, lighting, or similar purposes.

Ventilated. Provided with a means to permit circulation of air sufficient to remove an excess of heat, fumes, or vapors.

Volatile Flammable Liquid. A flammable liquid having a flash point below 38°C (100°F), or a flammable liquid whose temperature is above its flash point, or a Class II combustible liquid that has a vapor pressure not exceeding 276 kPa (40 psia) at 38°C (100°F) and whose temperature is above its flash point.

Voltage (of a circuit). The greatest root-mean-square (rms) (effective) difference of potential between any two conductors of the circuit concerned.

Informational Note: Some systems, such as 3-phase 4-wire, single-phase 3-wire, and 3-wire direct current, may have various circuits of various voltages.

Voltage, Nominal. A nominal value assigned to a circuit or system for the purpose of conveniently designating its voltage class (e.g., 120/240 volts, 480Y/277 volts, 600 volts). The actual voltage at which a circuit operates can vary from the nominal within a range that permits satisfactory operation of equipment.

Informational Note: See ANSI C84.1-2006, Voltage Ratings for Electric Power Systems and Equipment (60 Hz).

Voltage to Ground. For grounded circuits, the voltage between the given conductor and that point or conductor of the circuit that is grounded; for ungrounded circuits, the greatest voltage between the given conductor and any other conductor of the circuit.

Watertight. Constructed so that moisture will not enter the enclosure under specified test conditions.

Weatherproof. Constructed or protected so that exposure to the weather will not interfere with successful operation.

Informational Note: Rainproof, raintight, or watertight equipment can fulfill the requirements for weatherproof where varying weather conditions other than wetness, such as snow, ice, dust, or temperature extremes, are not a factor.

Article 110 — Requirements for Electrical Installations

Article 110 sets the stage for how to implement the rest of the NEC. This article contains a few of the most important and yet neglected parts of the Code. For example:

- How should you terminate conductors?
- What kinds of warnings, markings, and identification does a given installation require?
- What is the right working clearance for a given installation?
- What do the temperature limitations at terminals mean?
- What are the NEC requirements for dealing with flash protection?

I. General

110.3 — Examination, Identification, Installation, and Use of Equipment Changed From NEC 2008

The NEC added to the informational note related to special conditions of equipment.

NEC Language

110.3(A)(1) Informational Note: The NEC added a new second sentence to point out that there may be additional information regarding special conditions of use or other pertinent information marked on the equipment. Information may included with the product instructions, or provided with the listing or labeling information.

Examination. In judging equipment, considerations such as the following shall be evaluated:

(1) Suitability for installation and use in conformity with the provisions of this Code

Informational Note: Suitability of equipment use may be identified by a description marked on or provided with a product to identify the suitability of the product for a specific purpose, environment, or application. Special conditions of use or other limitations and other pertinent information may be marked on the equipment, included in the product instructions, or included in the appropriate listing and labeling information. Suitability of equipment may be evidenced by listing or labeling.

110.10 Circuit Impedance, Short-Circuit Current Ratings, and Other Characteristics.

Changed From NEC 2008

The title of the section was revised to include "short circuit current ratings." The text of the section was revised to indicate that a fault can be between any circuit conductor and the equipment grounding conductor(s).

NEC Language

The overcurrent protective devices, the total impedance, the equipment short-circuit current ratings, and other characteristics of the circuit to be protected shall be selected and coordinated to permit the circuit protective devices used to clear a fault to do so without extensive damage to the electrical equipment of the circuit.

This fault shall be assumed to be either between two or more of the circuit conductors or between any circuit conductor and the equipment grounding conductor(s) permitted in 250.118.

Listed equipment applied in accordance with their listing shall be considered to meet the requirements of this section.

110.11 Deteriorating Agents

Changed From NEC 2008

The words "**permanent**" and "**building**" were removed to clarify that it was the intent of the section to protect indoor equipment from damage during construction whether the equipment is temporary or permanent, and that construction is not limited to just building construction.

NEC Language

Unless identified for use in the operating environment, no conductors or equipment shall be located in damp or wet locations; where exposed to gases, fumes, vapors, liquids, or other agents that have a deteriorating effect on the conductors or equipment; or where exposed to excessive temperatures.

Informational Note No. 1: See 300.6 for protection against corrosion.

Informational Note No. 2: Some cleaning and lubricating compounds can cause severe deterioration of many plastic materials used for insulating and structural applications in equipment.

Equipment not identified for outdoor use and equipment identified only for indoor use, such as "dry locations," "indoor use only," "damp locations," or enclosure Types 1, 2, 5, 12, 12K, and/or 13, shall be protected against damage from the weather during construction.

Informational Note No. 3: See Table 110.28 for appropriate enclosure-type designations.

Table 110.28 Enclosure Selection										
Provides a Degree of Protection Against the Following Environmental Conditions	For Outdoor Use									
	Enclosure-Type Number									
	3	3R	3S	3X	3RX	3SX	4	4X	6	6P
Incidental contact with the enclosed equipment	X	X	X	X	X	X	X	X	X	X
Rain, snow, and sleet	X	X	X	X	X	X	X	X	X	X
Sleet*	—	—	X	—	—	X	—	—	—	—
Windblown dust	X	—	X	X	—	X	X	X	X	X
Hosedown	—	—	—	—	—	—	X	X	X	X
Corrosive agents	—	—	—	X	X	X	—	X	—	X
Temporary submersion	—	—	—	—	—	—	—	—	X	X
Prolonged submersion	—	—	—	—	—	—	—	—	—	X
Provides a Degree of Protection Against the Following Environmental Conditions	For Indoor Use									
	Enclosure-Type Number									
	1	2	4	4X	5	6	6P	12	12K	13
Incidental contact with the enclosed equipment	X	X	X	X	X	X	X	X	X	X
Falling dirt	X	X	X	X	X	X	X	X	X	X
Falling liquids and light splashing	—	X	X	X	X	X	X	X	X	X
Circulating dust, lint, fibers, and flyings	—	—	X	X	—	X	X	X	X	X
Settling airborne dust, lint, fibers, and flyings	—	—	X	X	X	X	X	X	X	X
Hosedown and splashing water	—	—	X	X	—	X	X	—	—	—
Oil and coolant seepage	—	—	—	—	—	—	—	X	X	X
Oil or coolant spraying and splashing	—	—	—	—	—	—	—	—	—	X
Corrosive agents	—	—	—	X	—	—	X	—	—	—
Temporary submersion	—	—	—	—	—	X	X	—	—	—
Prolonged submersion	—	—	—	—	—	—	X	—	—	—

*Mechanism shall be operable when ice covered.

Informational Note No. 1: The term *raintight* is typically used in conjunction with Enclosure Types 3, 3S, 3SX, 3X, 4, 4X, 6, and 6P. The term *rainproof* is typically used in conjunction with Enclosure Types 3R, and 3RX. The term *watertight* is typically used in conjunction with Enclosure Types 4, 4X, 6, 6P. The term *driptaight* is typically used in conjunction with Enclosure Types 2, 5, 12, 12K, and 13. The term *dusttight* is typically used in conjunction with Enclosure Types 3, 3S, 3SX, 3X, 5, 12, 12K, and 13.

Informational Note No. 2: Ingress protection (IP) ratings may be found in ANSI/NEMA 60529; *Degree of Protection Provided by Enclosures*. IP ratings are not a substitute for Enclosure Type ratings.

NEC 2011

Due to the size of this table, you might need to view it using your copy of NEC 2011.

110.14 Electrical Connections

Changed From NEC 2008

The NEC added general requirements to 110.14 for terminating flexible, fine-stranded cables and conductors.

This revision adds a second paragraph that requires that terminals and connectors used with conductors that have other than standard stranding shall be identified for the specific conductor class(s). A new Table 10 has been added to Chapter 9 to provide information on conductor stranding.

NEC Language

Because of different characteristics of dissimilar metals, devices such as pressure terminal or pressure splicing connectors and soldering lugs shall be identified for the material of the conductor and shall be properly installed and used.

Conductors of dissimilar metals shall not be intermixed in a terminal or splicing connector where physical contact occurs between dissimilar conductors (such as copper and aluminum, copper and copper-clad aluminum, or aluminum and copper-clad aluminum), unless the device is identified for the purpose and conditions of use.

Materials such as solder, fluxes, inhibitors, and compounds, where employed, shall be suitable for the use and shall be of a type that will not adversely affect the conductors, installation, or equipment.

Connectors and terminals for conductors more finely stranded than Class B and Class C stranding as shown in Chapter 9, Table 10, shall be identified for the specific conductor class or classes.

110.16 Arc-Flash Hazard Warning

Changed From NEC 2008

This was revised to reflect the **hazard warning label**.

The text was revised by replacing "in dwelling occupancies" with "dwelling units."

Panelboards installed in a dwelling unit are not required to have an arc flash warning label.

NEC Language

Electrical equipment, such as switchboards, panelboards, industrial control panels, meter socket enclosures, and motor control centers, that are in other than dwelling units, and are likely to require examination, adjustment, servicing, or maintenance while energized shall be field marked to warn qualified persons of potential electric arc flash hazards. The marking shall be located so as to be clearly visible to qualified persons before examination, adjustment, servicing, or maintenance of the equipment.

Informational Note No. 1: NFPA 70E-2009, Standard for Electrical Safety in the Workplace, provides assistance in determining severity of potential exposure, planning safe work practices, and selecting personal protective equipment.

Informational Note No. 2: ANSI Z535.4-1998, Product Safety Signs and Labels, provides guidelines for the design of safety signs and labels for application to products.

110.22 Identification of Disconnecting Means

(A) General. Each disconnecting means shall be legibly marked to indicate its purpose unless located and arranged so the purpose is evident. The marking shall be of sufficient durability to withstand the environment involved.

Changed From NEC 2008

110.22(B) **Engineered Series Combination Systems:** This was revised to clarify that the marking is required on the enclosure and the ratings selected under engineering supervision must be in accordance with 240.86(A).

NEC Language

(B) **Engineered Series Combination Systems.** Equipment enclosures for circuit breakers or fuses applied in compliance with series combination ratings selected under engineering supervision in accordance with 240.86(A) shall be legibly marked in the field as directed by the engineer to indicate the equipment has been applied with a series combination rating. The marking shall be readily visible and state the following:

CAUTION — ENGINEERED SERIES COMBINATION SYSTEM RATED _____ AMPERES.
IDENTIFIED REPLACEMENT COMPONENTS REQUIRED.

Changed From NEC 2008

110.22(C) **Tested Series Combination Systems:** This was revised to clarify that the marking is required on the enclosure and that the enclosure may also contain fuses as well as a circuit breaker.

NEC Language

(C) **Tested Series Combination Systems.** Equipment enclosures for circuit breakers or fuses applied in compliance with the series combination ratings marked on the equipment by the manufacturer in accordance with 240.86(B) shall be legibly marked in the field to indicate the equipment has been applied with a series combination rating. The marking shall be readily visible and state the following:

CAUTION — SERIES COMBINATION SYSTEM RATED ____ AMPERES.
IDENTIFIED REPLACEMENT COMPONENTS REQUIRED.

110.24 Available Fault Current

Changed From NEC 2008

This new section requires service equipment (other than dwelling units) to be field-marked with the amount of available short-circuit current when installed or modified.

Highlight

This new section adds to existing requirements for identifying and labeling Arc Flash hazards.

Electrical equipment is required to have its interrupting rating or short circuit current rating be at or above the circuit's available fault current.

The new requirement will be for equipment other than dwelling units and will require that it be legibly marked in the field with the available fault current. This label must contain the installation date and must be durable enough to withstand its operating environment. After installation, any changes that are made to the circuit that could affect the available fault current at the device means that the available fault current must be verified and recalculated. This is done to be sure the equipment interrupting ratings meet or exceed the available fault current at the line terminals of the equipment. This article ensures that the available fault current is known at the time of installation and that any changes made to the circuit are going to be evaluated to maintain a safe circuit.

The only exception to this rule is in industrial installations where conditions of maintenance and supervision ensure that only qualified persons service the equipment.

NEC Language

Electrical equipment is required to have an interrupting rating or short-circuit current rating equal to or greater than the available fault current.

Any equipment operating with ratings less than the available fault current is in violation of the NEC and creates a potentially unsafe condition. Knowing the available short-circuit current is an essential part of not only the installation of service equipment, but the inspection and approval of such equipment as well.

Changed From NEC 2008

110.24, 110.24(A), 110.24(B), 110.24 **Exception**: A new section has been added to require service equipment in other than dwelling units to be marked with the maximum available fault current. The label must be suitable to withstand the environment and include the date the fault current was calculated.

NEC Language

The maximum available fault must be verified or recalculated and the label updated when a modification is made that can affect the available fault current.

The field marking is not required in industrial installations where the conditions of maintenance and supervision ensure that qualified persons will service the equipment.

(A) **Field Marking**. Service equipment in other than dwelling units shall be legibly marked in the field with the maximum available fault current. The field marking(s) shall include the date the fault current calculation was performed and be of sufficient durability to withstand the environment involved.

(B) **Modifications**. When modifications to the electrical installation occur that affect the maximum available fault current at the service, the maximum available fault current shall be verified or recalculated as necessary to ensure the service equipment ratings are sufficient for the maximum available fault current at the line terminals of the equipment. The required field marking(s) in 110.24(A) shall be adjusted to reflect the new level of maximum available fault current.

Exception: The field marking requirements in 110.24(A) and 110.24(B) shall not be required in industrial installations where conditions of maintenance and supervision ensure that only qualified persons service the equipment.

110.26 Spaces About Electrical Equipment Changed From NEC 2008

The NEC added a new exception to **working space** requirements to address meters that often extend into the required working space for electrical equipment.

NEC Language

Access and working space shall be provided and maintained about all electrical equipment to permit ready and safe operation and maintenance of such equipment.

(A) Working Space. Working space for equipment operating at 600 volts, nominal, or less to ground and likely to require examination, adjustment, servicing, or maintenance while energized shall comply with the dimensions of 110.26(A)(1), (A)(2), and (A)(3) or as required or permitted elsewhere in this Code.

(1) Depth of Working Space. The depth of the working space in the direction of live parts shall not be less than that specified in Table 110.26(A)(1) unless the requirements of 110.26(A)(1)(a), (A)(1)(b), or (A)(1)(c) are met. Distances shall be measured from the exposed live parts or from the enclosure or opening if the live parts are enclosed.

Table 110.26(A)(1) Working Spaces

Nominal Voltage to Ground	Minimum Clear Distance		
	Condition 1	Condition 2	Condition 3
0-150	914 mm (3 ft)	914 mm (3 ft)	914 mm (3 ft)
151-600	914 mm (3 ft)	1.07 m (3 ft 6 in.)	1.22 m (4 ft)

Note: Where the conditions are as follows:

Condition 1 — Exposed live parts on one side of the working space and no live or grounded parts on the other side of the working space, or exposed live parts on both sides of the working space that are effectively guarded by insulating materials.

Condition 2 — Exposed live parts on one side of the working space and grounded parts on the other side of the working space. Concrete, brick, or tile walls shall be considered as grounded.

Condition 3 — Exposed live parts on both sides of the working space.

NEC 2011

(a) **Dead-Front Assemblies.** Working space shall not be required in the back or sides of assemblies, such as dead-front switchboards or motor control centers, where all connections and all renewable or adjustable parts, such as fuses or switches, are accessible from locations other than the back or sides. Where rear access is required to work on nonelectrical parts on the back of enclosed equipment, a minimum horizontal working space of 762 mm (30 in.) shall be provided.

(b) **Low Voltage.** By special permission, smaller working spaces shall be permitted where all exposed live parts operate at not greater than 30 volts rms, 42 volts peak, or 60 volts dc.

(c) **Existing Buildings.** In existing buildings where electrical equipment is being replaced, Condition 2 working clearance shall be permitted between dead-front switchboards,

panelboards, or motor control centers located across the aisle from each other where conditions of maintenance and supervision ensure that written procedures have been adopted to prohibit equipment on both sides of the aisle from being open at the same time and qualified persons who are authorized will service the installation.

(2) Width of Working Space. The width of the working space in front of the electrical equipment shall be the width of the equipment or 762 mm (30 in.), whichever is greater. In all cases, the work space shall permit at least a 90 degree opening of equipment doors or hinged panels.

(3) Height of Working Space. The work space shall be clear and extend from the grade, floor, or platform to a height of 2.0 m (6½ ft) or the height of the equipment, whichever is greater. Within the height requirements of this section, other equipment that is associated with the electrical installation and is located above or below the electrical equipment shall be permitted to extend not more than 150 mm (6 in.) beyond the front of the electrical equipment.

Exception No. 1: In existing dwelling units, service equipment or panelboards that do not exceed 200 amperes shall be permitted in spaces where the height of the working space is less than 2.0 m (6½ ft).

Changed From NEC 2008

110.26(A)(3) Exception No. 2: The NEC added a new exception to allow meters that have been installed in meter sockets to extend beyond the other equipment, provided the meter socket meets the requirements of the section.

NEC Language

Exception No. 2: Meters that are installed in meter sockets shall be permitted to extend beyond the other equipment. The meter socket shall be required to follow the rules of this section.

Changed From NEC 2008

110.26[D] Illumination states that Lighting sources for working spaces about electrical equipment cannot be controlled by automatic means only. This was revised to expand the requirements to include other rooms that may not be "electric rooms," but which have the electrical equipment in them.

NEC Language

(D) Illumination. Illumination shall be provided for all working spaces about service equipment, switchboards, panelboards, or motor control centers installed indoors and shall not be controlled by automatic means only. Additional lighting outlets shall not be required where the work space is illuminated by an adjacent light source or as permitted by 210.70(A)(1), Exception No. 1, for switched receptacles.

Highlight

Illumination of electrical equipment is critical to the safety of those working with and around it. Without proper illumination, electrical personnel would be subject to unnecessary risks by not being able to clearly see.

This issue is addressed in the 2011 NEC and it specifies that all working spaces about service equipment, switchboards, panelboards, or motor control centers installed indoors and shall be illuminated.

Under the 2008 NEC wording, it would be possible that a storage closet with an electrical panel could be supplied with only an automatic sensor switch for illumination. To address this, this section also states that the lighting shall not be controlled by automatic means only. Lighting

circuits can be controlled by automatic circuits, but must also be controlled by a circuit which can operate in a manual mode.

The reasoning is obvious. The illumination should have no chance to be interrupted or automatically turned off while electrical personnel are present in the equipment vicinity.

Changed From NEC 2008

110.26(E) Dedicated Equipment Space: Section 110.26(E) and the exception have been incorporated into 110.26(A)(3).

NEC Language

(E) Dedicated Equipment Space. All switchboards, panelboards, and motor control centers shall be located in dedicated spaces and protected from damage.

Exception: Control equipment that by its very nature or because of other rules of the Code must be adjacent to or within sight of its operating machinery shall be permitted in those locations.

II. 600 Volts, Nominal, or Less

110.28 Enclosure Types.

Changed From NEC 2008

The list of items that are required to be marked with an enclosure type in 110.28 has been expanded. Section 110.28 has been relocated from 110.20

NEC Language

110.28 and Table 110.28: Former Section 110.20 and Table 110.20 were renumbered as 110.28 and Table 110.28, respectively, so they will only apply to installations of equipment rated 600 volts or less. The references to enclosures have been expanded to include additional types of enclosures.

Enclosures (other than surrounding fences or walls) of switchboards, panelboards, industrial control panels, motor control centers, meter sockets, enclosed switches, transfer switches, power outlets, circuit breakers, adjustable-speed drive systems, pullout switches, portable power distribution equipment, termination boxes, general-purpose transformers, fire pump controllers, fire pump motors, and motor controllers, rated not over 600 volts nominal and intended for such locations, shall be marked with an enclosure-type number as shown in Table 110.28.

Table 110.28 (Shown below) shall be used for selecting these enclosures for use in specific locations other than hazardous (classified) locations. The enclosures are not intended to protect against conditions such as condensation, icing, corrosion, or contamination that may occur within the enclosure or enter via the conduit or unsealed openings.

Table 110.31 Enclosure Selection										
Provides a Degree of Protection Against the Following Environmental Conditions	For Outdoor Use									
	Enclosure-Type Number									
	3	3R	3S	3X	3RA	3XA	4	4X	6	6P
Incidental contact with the enclosed equipment	X	X	X	X	X	X	X	X	X	X
Rain, snow, and sleet	X	X	X	X	X	X	X	X	X	X
Sleet*	—	—	X	—	—	X	—	—	—	—
Windblown dust	X	—	X	X	—	X	X	X	X	X
Haze/dust	—	—	—	—	—	—	X	X	X	X
Corrosive agents	—	—	—	X	X	X	—	X	—	X
Inspraying substances	—	—	—	—	—	—	—	—	X	X
Prepacked substances	—	—	—	—	—	—	—	—	—	X
Provides a Degree of Protection Against the Following Environmental Conditions	For Indoor Use									
	Enclosure-Type Number									
	1	2	4	4X	5	6	6P	12	12K	13
Incidental contact with the enclosed equipment	X	X	X	X	X	X	X	X	X	X
Falling dirt	X	X	X	X	X	X	X	X	X	X
Falling liquids and light splashing	—	X	X	X	X	X	X	X	X	X
Circulating dust, lint, fibers, and flyings	—	—	X	X	—	X	X	X	X	X
Settling airborne dust, lint, fibers, and flyings	—	—	X	X	X	X	X	X	X	X
Haze/dust and splashing water	—	—	X	X	—	X	X	—	—	—
Oil and coolant leakage	—	—	—	—	—	—	—	X	X	X
Oil or coolant spraying and splashing	—	—	—	—	—	—	—	—	—	X
Corrosive agents	—	—	—	X	—	—	X	—	—	—
Inspraying substances	—	—	—	—	—	X	X	—	—	—
Prepacked substances	—	—	—	—	—	—	X	—	—	—

*Mechanisms shall be operable when ice covered.
 Informational Note No. 1: The term *rainproof* is typically used in conjunction with Enclosure Types 3, 3S, 3X, 4, 4X, 6, and 6P. The term *corrosion-resistant* is typically used in conjunction with Enclosure Types 3R, and 3RA. The term *weatherproof* is typically used in conjunction with Enclosure Types 4, 4X, 6, 6P. The term *drainproof* is typically used in conjunction with Enclosure Types 2, 5, 12, 12K, and 13. The term *dustproof* is typically used in conjunction with Enclosure Types 3, 3S, 3X, 3K, 5, 12, 12K, and 13.
 Informational Note No. 2: Ingress protection (IP) ratings may be found in ANSI/MIL-STD-883C, *Degree of Protection Provided by Enclosures*. IP ratings are not a substitute for Enclosure Type ratings.

NEC 2011

Due to the size of this table, you might need to view it in your copy of NEC 2011.

110.31 Enclosure for Electrical Installations Changed From NEC 2008

Requirements for electrical equipment located in electrical vaults have been rearranged and expanded for usability.

NEC Language

Electrical installations in a vault, room, or closet or in an area surrounded by a wall, screen, or fence, access to which is controlled by a lock(s) or other approved means, shall be considered to be accessible to qualified persons only. The type of enclosure used in a given case shall be designed and constructed according to the nature and degree of the hazard(s) associated with the installation.

For installations other than equipment as described in 110.31(D), a wall, screen, or fence shall be used to enclose an outdoor electrical installation to deter access by persons who are not qualified. A fence shall not be less than 2.1 m (7 ft) in height or a combination of 1.8 m (6 ft) or more of fence fabric and a 300-mm (1-ft) or more extension utilizing three or more strands of barbed wire or equivalent. The distance from the fence to live parts shall be not less than given in Table 110.31.

Table 110.31 Minimum Distance from Fence to Live Parts

Nominal Voltage	Minimum Distance to Live Parts	
	m	ft
601 – 13,799	3.05	10
13,800– 230,000	4.57	15
Over 230,000	5.49	18

Note: For clearances of conductors for specific system voltages and typical BIL ratings, see ANSI C2-2007, *National Electrical Safety Code*.

NEC 2011

Informational Note: See Article 450 for construction requirements for transformer vaults.

(A) Electrical Vaults. Where an electrical vault is required or specified for conductors and equipment operating at over 600 volts, nominal, the following shall apply.

Changed From NEC 2008

110.31(A)(1) – (5): This was revised to include additional aspects of vault construction, consistent with Part III of Article 450 covering transformer vault construction.

A new exception has been added to recognize that the construction rating can be reduced when a fire suppression system is in place.

Two new Informational Notes have been added to direct users to additional information on resistive construction.

NEC Language

(1) Walls and Roof. The walls and roof shall be constructed of materials that have adequate structural strength for the conditions, with a minimum fire rating of 3 hours. For the purpose of this section, studs and wallboard construction shall not be permitted.

(2) Floors. The floors of vaults in contact with the earth shall be of concrete that is not less than 102 mm (4 in.) thick, but where the vault is constructed with a vacant space or other stories below it, the floor shall have adequate structural strength for the load imposed on it and a minimum fire resistance of 3 hours.

(3) Doors. Each doorway leading into a vault from the building interior shall be provided with a tight-fitting door that has a minimum fire rating of 3 hours. The authority having jurisdiction shall be permitted to require such a door for an exterior wall opening where conditions warrant.

Exception to (1), (2), and (3): Where the vault is protected with automatic sprinkler, water spray, carbon dioxide, or halon, construction with a 1-hour rating shall be permitted.

(4) Locks. Doors shall be equipped with locks, and doors shall be kept locked, with access allowed only to qualified persons. Personnel doors shall swing out and be equipped with panic bars, pressure plates, or other devices that are normally latched but that open under simple pressure.

(5) **Transformers.** Where a transformer is installed in a vault as required by Article 450, the vault shall be constructed in accordance with the requirements of Part III of Article 450.

Informational Note No. 1: For additional information, see ANSI/ASTM E119-1995, Method for Fire Tests of Building Construction and Materials, NFPA 251-2006, Standard Methods of Tests of Fire Resistance of Building Construction and Materials, and NFPA 80-2010, Standard for Fire Doors and Other Opening Protectives.

Informational Note No. 2: A typical 3-hour construction is 150 mm (6 in.) thick reinforced concrete.

110.34 Work Space and Guarding

NEC Language

(A) **Working Space.** Except as elsewhere required or permitted in this Code, equipment likely to require examination, adjustment, servicing, or maintenance while energized shall have clear working space in the direction of access to live parts of the electrical equipment and shall be not less than specified in Table 110.34(A) shown below. Distances shall be measured from the live parts, if such are exposed, or from the enclosure front or opening if such are enclosed.

Changed From NEC 2008

110.34(A) Exception: This was revised for consistency with the use of the term "nonelectrical parts."
--

NEC Language

Exception: Working space shall not be required in back of equipment such as dead-front switchboards or control assemblies where there are no renewable or adjustable parts (such as fuses or switches) on the back and where all connections are accessible from locations other than the back. Where rear access is required to work on **nonelectrical parts** on the back of enclosed equipment, a minimum working space of 762 mm (30 in.) horizontally shall be provided.

Table 110.34(A) Minimum Depth of Clear Working Space at Electrical Equipment

Nominal Voltage to Ground	Minimum Clear Distance		
	Condition 1	Condition 2	Condition 3
601–2500 V	900 mm (3 ft)	1.2 m (4 ft)	1.5 m (5 ft)
2501–9000 V	1.2 m (4 ft)	1.5 m (5 ft)	1.8 m (6 ft)
9001–25,000 V	1.5 m (5 ft)	1.8 m (6 ft)	2.8 m (9 ft)
25,001 V–75 kV	1.8 m (6 ft)	2.5 m (8 ft)	3.0 m (10 ft)
Above 75 kV	2.5 m (8 ft)	3.0 m (10 ft)	3.7 m (12 ft)

Note: Where the conditions are as follows:

Condition 1 — Exposed live parts on one side of the working space and no live or grounded parts on the other side of the working space, or exposed live parts on both sides of the working space that are effectively guarded by insulating materials.

Condition 2 — Exposed live parts on one side of the working space and grounded parts on the other side of the working space. Concrete, brick, or tile walls shall be considered as grounded.

Condition 3 — Exposed live parts on both sides of the working space.

NEC 2011

V. Manholes and Other Electrical Enclosures Intended for Personnel Entry, All Voltages

110.74 Conductor Installation

Changed From NEC 2008

110.74: This was divided into titled subdivisions for consistency with the NEC Manual of Style to help to distinguish the requirements for installations operating at 600 volts or less from those operating at over 600 volts.

NEC Language

Conductors installed in manholes and other enclosures intended for personnel entry shall be cabled, racked up, or arranged in an approved manner that provides ready and safe access for persons to enter for installation and maintenance. The installation shall comply with 110.74(A) or 110.74(B), as applicable.

(A) **600 Volts, Nominal, or Less.** Wire bending space for conductors operating at 600 volts or less shall be provided in accordance with the requirements of 314.28.

(B) **Over 600 Volts, Nominal.** Conductors operating at over 600 volts shall be provided with bending space in accordance with 314.71(A) and (B), as applicable.

Exception: Where 314.71(B) applies, each row or column of ducts on one wall of the enclosure shall be calculated individually, and the single row or column that provides the maximum distance shall be used.

Chapter 2 - Wiring and Protection

Article 200 — Use and Identification of Grounded Conductors

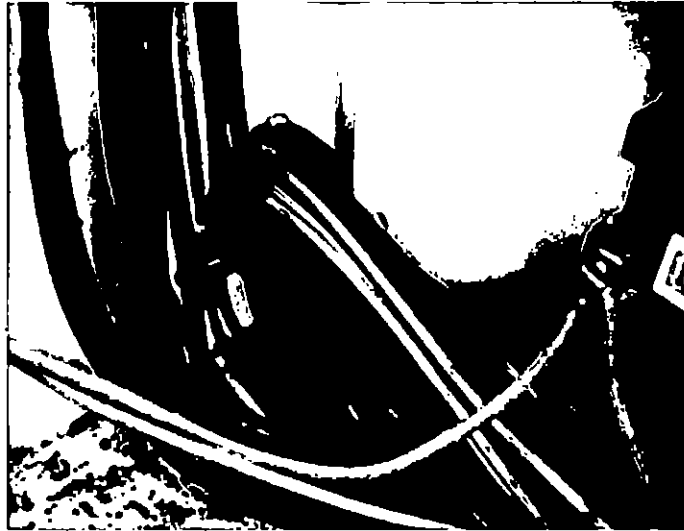

IAEI Magazine

Chapter 2 is primarily concerned with correctly sizing and protecting circuits. Every article in this chapter deals with different aspects of this purpose. This differs from the purpose of Chapter 3, which is to correctly install the conductors that make up those circuits.

NEC Language

Article 200 provides requirements for the following:

- (1) Identification of terminals
- (2) Grounded conductors in premises wiring systems
- (3) Identification of grounded conductors

Informational Note: See Article 100 for definitions of Grounded Conductor, Equipment Grounding Conductor, and Grounding Electrode Conductor.

Highlight

The requirements of Article 200 cover the grounded conductor's use in premises wiring systems and the acceptable methods for identifying grounded conductors and the terminals to which they are connected.

Identification of grounded conductors is a long-standing, fundamental safety concept that helps ensure proper connection of the conductor throughout an electrical system. Proper connection and maintaining correct polarity are essential to ensuring safe interface with wiring devices, appliances, and portable and permanently installed luminaires.

In accordance with the Article 100 definition of grounded conductor, it is a conductor that is intentionally grounded, meaning that it is intentionally connected to the earth.

The grounded conductor is often, but not always, the neutral conductor. As defined in Article 100, a neutral conductor is one that is connected to the neutral point of an electrical system. For example, in a single-phase 2-wire or in a 3-phase corner-grounded delta system, the intentionally grounded conductor is not a neutral conductor because it is not connected to a system neutral point.

Through its very nature of being connected to the same grounding electrode system as the non-current-carrying metal parts of electrical equipment, there is generally no potential difference between the grounded conductor and those grounded metal parts. However, unlike an equipment grounding conductor, the grounded conductor is a circuit conductor and as such is a current-carrying conductor. Whether it is referred to as the grounded conductor or as the neutral conductor, the white or gray marking on a circuit conductor indicates it is a conductor that is intentionally connected to the earth.

Electric shock injuries and electrocutions have occurred as a result of working on the grounded conductor while the circuit is energized. Extreme caution must be exercised where the grounded (neutral) conductor is part of a multiwire branch circuit [see 210.4(B) on disconnecting means for multiwire branch circuits], and it should be noted that 300.13 does not permit the wiring terminals of a device, such as a receptacle, to be the means of maintaining the continuity of the grounded conductor in that type of branch circuit.

In addition to the requirements in this article, the use and installation of the grounded conductor are covered extensively by the requirements in Article 250.

200.2 General

Changed from NEC 2008

The 2011 NEC eliminated various sections of the Code where a grounded conductor was not required.

NEC Language

The following language was deleted:

~~All premises wiring systems other than circuits and systems exempted or prohibited by 210.10, 215.7, 250.22, 250.162, 503.155, 517.63, 668.11, 668.21, and 690.41, Exception, shall have a grounded conductor that is identified in accordance with 200.6. The~~

The following statement is retained:

Grounded conductors shall comply with 200.2(A) and (B).

(A) **Insulation.** The grounded conductor, where insulated, shall have insulation that is (1) suitable, other than color, for any ungrounded conductor of the same circuit on circuits of less than 1000 volts or impedance grounded neutral systems of 1 kV and over, or (2) rated not less than 600 volts for solidly grounded neutral systems of 1 kV and over as described in 250.184(A).

(B) **Continuity.** The continuity of a grounded conductor shall not depend on a connection to a metallic enclosure, raceway, or cable armor.

Informational Note: See 300.13(B) for the continuity of grounded conductors used in multiwire branch circuits.

200.2(B) FPN: The NEC added a new informational note referencing 300.13(B) for requirement on continuity of grounded conductor in multiwire branch circuit.

200.4 Neutral Conductors.

Changed From NEC 2008

A new section dealing with the permissive use of a neutral conductor was added to Article 200.

This prohibits a neutral conductor to be used for more than one branch circuit or feeder.

200.4: The NEC added a new requirement prohibiting common neutral conductor for multiple circuits.

NEC Language

Neutral conductors shall not be used for more than one branch circuit, for more than one multiwire branch circuit, or for more than one set of ungrounded feeder conductors unless specifically permitted elsewhere in this Code.

Highlight

To avoid confusion regarding the installation of neutral conductors, the code making panels have added this section to provide additional clarity.

If you read 215.4(A), it states the requirements for installation of common neutral conductors.

The specific listing of these requirements implies that the Code is attempting to prohibit the use of common neutral conductors in other installations, but it does not state that clearly.

The purpose of this new Article is to state more clearly that neutral conductors shall not be permitted to be used for more than one multiwire branch circuit or for more than one set of ungrounded feeder conductors unless specifically permitted elsewhere in this Code. The new wording more specifically applies to multiwire branch circuits and feeders.

200.6 Means of Identifying Grounded Conductors.

Changed from NEC 2008

This section has been reorganized into a list format. The list format is easier to read, and is also easier to understand.

Highlight

This section deals with the means to identify grounded conductors.

More commonly referred to in the field as the "Neutral", this conductor has very specific identification requirements.

In the previous version of the code, the means to identify the conductors was listed in paragraph format. In order to clear confusion and become more consistent with the 200.6(B) listing format, it was decided to specify these items in a list item format. The requirements are now listed as follows below:

Changed From NEC 2008

200.6(A): This is an editorial revision of existing information into a numbered list.

NEC Language

(A) Sizes 6 AWG or Smaller. An insulated grounded conductor of 6 AWG or smaller shall be identified by one of the following means:

- (1) A continuous white outer finish.

- (2) A continuous gray outer finish.
- (3) Three continuous white stripes along the conductor's entire length on other than green insulation.
- (4) Wires that have their outer covering finished to show a white or gray color but have colored tracer threads in the braid identifying the source of manufacture shall be considered as meeting the provisions of this section.
- (5) The grounded conductor of a mineral-insulated, metal-sheathed cable shall be identified at the time of installation by distinctive marking at its terminations.
- (6) A single-conductor, sunlight-resistant, outdoor-rated cable used as a grounded conductor in photovoltaic power systems, as permitted by 690.31, shall be identified at the time of installation by distinctive white marking at all terminations.

Changed from NEC 2008

200.6(B) Sizes 4 AWG or Larger: This was revised to clarify identification requirements for grounded conductors using 4 AWG and larger wire. The term "larger than 6 AWG" has been changed.

NEC Language

(B) **Sizes 4 AWG or Larger.** An insulated grounded conductor 4 AWG or larger shall be identified by one of the following means:

- (1) A continuous white outer finish.
- (2) A continuous gray outer finish
- (3) Three continuous white stripes along its entire length on other than green insulation.

Changed from NEC 2008

200.6(B)(4): The NEC revised the requirement for on-site identification scheme where grounded conductors of multiple systems are in the same enclosure.

NEC Language

(4) At the time of installation, by a distinctive white or gray marking at its terminations. This marking shall encircle the conductor or insulation.

Highlight

Of the four methods to identify larger neutral conductors allowed by this section, only three of the methods were written in list format. This change provides uniformity in Section 200.6 by incorporating old methods of identification into lists.

This rule applies to any conductor that's 4 AWG or larger. This change clarifies that fact, and it also makes for an easier requirement to understand. Most people tend to agree that 4 AWG is easier to understand and visualize than larger than 6 AWG.

NEC Language

(C) **Flexible Cords.** An insulated conductor that is intended for use as a grounded conductor, where contained within a flexible cord, shall be identified by a white or gray outer finish or by methods permitted by 400.22.

(D) **Grounded Conductors of Different Systems.** Where grounded conductors of different systems are installed in the same raceway, cable, box, auxiliary gutter, or other

type of enclosure, each grounded conductor shall be identified by system. Identification that distinguishes each system grounded conductor shall be permitted by one of the following means:

- (1) One system grounded conductor shall have an outer covering conforming to 200.6(A) or (B).
- (2) The grounded conductor(s) of other systems shall have a different outer covering conforming to 200.6(A) or 200.6(B) or by an outer covering of white or gray with a readily distinguishable colored stripe other than green running along the insulation.
- (3) Other and different means of identification as allowed by 200.6(A) or (B) that will distinguish each system grounded conductor.

The means of identification shall be documented in a manner that is readily available or shall be permanently posted where the conductors of different systems originate.

(E) Grounded Conductors of Multiconductor Cables. The insulated grounded conductors in a multiconductor cable shall be identified by a continuous white or gray outer finish or by three continuous white stripes on other than green insulation along its entire length. Multiconductor flat cable 4 AWG or larger shall be permitted to employ an external ridge on the grounded conductor.

Exception No. 1: Where the conditions of maintenance and supervision ensure that only qualified persons service the installation, grounded conductors in multiconductor cables shall be permitted to be permanently identified at their terminations at the time of installation by a distinctive white marking or other equally effective means.

Exception No. 2: The grounded conductor of a multiconductor varnished-cloth-insulated cable shall be permitted to be identified at its terminations at the time of installation by a distinctive white marking or other equally effective means.

Informational Note: The color gray may have been used in the past as an ungrounded conductor. Care should be taken when working on existing systems.

200.7 — Use of Insulation of a White or Gray Color or with Three Continuous White Stripes

Changed from NEC 2008

The NEC re-identified that switch loops can be used only for the supply to the switch but not as a return conductor from the switch to the outlet.

200.7: Combined requirements for identifying white colored conductors in cable assemblies used as ungrounded conductors to supply utilization equipment or in switch loops. Clarified that marking tape is permitted as a method to re-identify conductors with white colored insulation.

NEC Language

(A) **General.** The following shall be used only for the grounded circuit conductor, unless otherwise permitted in 200.7(B) and (C):

- (1) A conductor with continuous white or gray covering
- (2) A conductor with three continuous white stripes on other than green insulation
- (3) A marking of white or gray color at the termination

(B) **Circuits of Less Than 50 Volts.** A conductor with white or gray color insulation or three continuous white stripes or having a marking of white or gray at the termination for

circuits of less than 50 volts shall be required to be grounded only as required by 250.20(A).

Changed from NEC 2008

200.7 (C)(1): Reidentified switch loops can be used only for the supply to the switch but not as a return conductor from the switch to the outlet.

NEC Language

(C) Circuits of 50 Volts or More. The use of insulation that is white or gray or that has three continuous white stripes for other than a grounded conductor for circuits of 50 volts or more shall be permitted only as in (1) and (2).

(1) If part of a cable assembly that has the insulation permanently reidentified to indicate its use as an ungrounded conductor by marking tape, painting, or other effective means at its termination and at each location where the conductor is visible and accessible. Identification shall encircle the insulation and shall be a color other than white, gray, or green. If used for single-pole, 3-way or 4-way switch loops, the reidentified conductor with white or gray insulation or three continuous white stripes shall be used only for the supply to the switch, but not as a return conductor from the switch to the outlet.

ARTICLE 210 — Branch Circuits

This article contains the requirements for branch circuits, such as conductor sizing and identification, GFCI protection and receptacle and lighting outlet requirements.

I. General Provisions

210.4 Multiwire Branch Circuits

Changed From NEC 2008

The NEC added a new **Informational Note** to alert of requirements in Article 240. This rule is intended to prevent people from working on energized circuits thought to be disconnected.

210.4(B) **Disconnecting Means**: The NEC added a new informational note referencing 240.15(B) for requirements covering single-pole circuit breakers used as disconnecting means.

NEC Language

(B) **Disconnecting Means**. Each multiwire branch circuit shall be provided with a means that will simultaneously disconnect all ungrounded conductors at the point where the branch circuit originates.

Informational Note: See 240.15(B) for information on the use of single-pole circuit breakers as the disconnecting means.

Changed from NEC 2008

210.4(D) **Grouping**: This was revised for consistency with industry nomenclature and to clarify where grouping of conductors is required. The term **wire ties** was changed to **cable ties** in this subsection.

NEC Language

(D) **Grouping.** The ungrounded and grounded circuit conductors of each multiwire branch circuit shall be grouped by cable ties or similar means in at least one location within the panelboard or other point of origination.

Exception: The requirement for grouping shall not apply if the circuit enters from a cable or raceway unique to the circuit that makes the grouping obvious.

210.5 Identification for Branch Circuits

Changed from NEC 2008

210.5(C) **Identification of Ungrounded Conductors:** This was revised to improve clarity of requirements.

NEC Language

(C) **Identification of Ungrounded Conductors.** Ungrounded conductors shall be identified in accordance with 210.5(C)(1), (2), and (3).

(1) **Application.** Where the premises wiring system has branch circuits supplied from more than one nominal voltage system, each ungrounded conductor of a branch circuit shall be identified by phase or line and system at all termination, connection, and splice points.

(2) **Means of Identification.** The means of identification shall be permitted to be by separate color coding, marking tape, tagging, or other approved means.

(3) **Posting of Identification Means.** The method utilized for conductors originating within each branch-circuit panelboard or similar branch-circuit distribution equipment shall be documented in a manner that is readily available or shall be permanently posted at each branch-circuit panelboard or similar branch-circuit distribution equipment.

210.6 Branch-Circuit Voltage Limitations

NEC Language

The nominal voltage of branch circuits shall not exceed the values permitted by 210.6(A) through (E).

(A) **Occupancy Limitation.** In dwelling units and guest rooms or guest suites of hotels, motels, and similar occupancies, the voltage shall not exceed 120 volts, nominal, between conductors that supply the terminals of the following:

(1) **Luminaires**

(2) Cord-and-plug-connected loads 1440 volt-amperes, nominal, or less or less than $\frac{1}{4}$ hp

(B) **120 Volts Between Conductors.** Circuits not exceeding 120 volts, nominal, between conductors shall be permitted to supply the following:

(1) The terminals of lampholders applied within their voltage ratings

(2) Auxiliary equipment of electric-discharge lamps

(3) Cord-and-plug-connected or permanently connected utilization equipment

(C) **277 Volts to Ground.** Circuits exceeding 120 volts, nominal, between conductors and not exceeding 277 volts, nominal, to ground shall be permitted to supply the following:

Changed from NEC 2008

210.6(C) (1): This was revised to include listed light emitting diode (LED) type luminaires.

NEC Language

(1) Listed electric-discharge or listed light-emitting diode-type luminaires

210.7 Multiple Branch Circuits

Changed from NEC 2008

This section was revised to omit needless information and more aptly describe the requirement.

210.7: This was revised to remove text covered in Part III of Article 210.

NEC Language

Where two or more branch circuits supply devices or equipment on the same yoke, a means to simultaneously disconnect the ungrounded conductors supplying those devices shall be provided at the point at which the branch circuits originate.

210.8 — Ground-Fault Circuit-Interrupter — Protection for Personnel

Changed from NEC 2008

210.8: All GFCI devices are now required to be installed in a readily accessible location.

Highlight

GFCI protection is required to be installed in areas where the potential for electrical hazard due to moisture or exposure to water is increased.

In dwelling units per Article 210.8(A), GFCI receptacles are required to be installed in bathrooms, garages, outdoors, in crawl spaces, unfinished basements, kitchens, sinks, and boathouses.

They are also required per Article 210.8(B) in non-dwelling units in bathrooms, kitchens, rooftops, and outdoors.

Per manufacturer's recommendations, a GFCI should be tested once per month.

In order to make testing easier and safer for the home or property owner, it makes sense that they be installed in areas that are easy to access.

In previous Code versions, there was no requirement for the accessibility of the GFCI itself. Sections 210.8(A) for dwelling units, and 210.8(B) for non-dwelling units will now require that they always be installed in a readily accessible location. In other words they can not be installed in locations such as behind refrigerators, etc.

NEC Language

Ground-fault circuit-interruption for personnel shall be provided as required in 210.8(A) through (C). The ground-fault circuit-interrupter shall be installed in a readily accessible location.

Informational Note: See 215.9 for ground-fault circuit-interrupter protection for personnel on feeders.

(A) **Dwelling Units.** All 125-volt, single-phase, 15- and 20-ampere receptacles installed in the locations specified in 210.8(A)(1) through (8) shall have ground-fault circuit-interrupter protection for personnel.

(1) **Bathrooms**

(2) **Garages,** and also accessory buildings that have a floor located at or below grade level not intended as habitable rooms and limited to storage areas, work areas, and areas of similar use

(3) **Outdoors**

Changed from NEC 2008

210.8(A)(3) **Exception:** This was revised to include pipeline and vessel heating equipment. The NEC added a new allowance for ground-fault protection of equipment for pipeline and vessel heating equipment.

NEC Language

Exception to (3): Receptacles that are not readily accessible and are supplied by a branch circuit dedicated to electric snow-melting, deicing, or pipeline and vessel heating equipment shall be permitted to be installed in accordance with 426.28 or 427.22, as applicable.

(4) **Crawl spaces — at or below grade level**

(5) **Unfinished basements** — for purposes of this section, unfinished basements are defined as portions or areas of the basement not intended as habitable rooms and limited to storage areas, work areas, and the like

Exception to (5): A receptacle supplying only a permanently installed fire alarm or burglar alarm system shall not be required to have ground-fault circuit-interrupter protection.

Informational Note: See 760.41(B) and 760.121(B) for power supply requirements for fire alarm systems.

Receptacles installed under the exception to 210.8(A)(5) shall not be considered as meeting the requirements of 210.52(G).

(6) **Kitchens**— where the receptacles are installed to serve the countertop surfaces.

Changed from NEC 2008

210.8(A)(7) **Sinks:** This was revised to apply to all sinks other than those located in a kitchen. This clarifies and expands the type of sinks where GFCI protection is required for receptacles.

A GFCI is now required for all 125-volt, single-phase, 15- and 20- ampere receptacles installed within 1.8 m (6 ft) of the outside edge of a dwelling unit sink (not just laundry, utility or wet bar sinks).

NEC Language

(7) **Sinks** — located in areas other than kitchens where receptacles are installed within 1.8 m (6 ft) of the outside edge of the sink

(8) **Boathouses**

(B) **Other Than Dwelling Units.** All 125-volt, single-phase, 15- and 20-ampere receptacles installed in the locations specified in 210.8(B)(1) through (8) shall have ground-fault circuit-interrupter protection for personnel.

(1) **Bathrooms**

(2) Kitchens**(3) Rooftops****(4) Outdoors**

Exception No. 1 to (3) and (4): Receptacles that are not readily accessible and are supplied by a branch circuit dedicated to electric snow-melting, deicing, or pipeline and vessel heating equipment shall be permitted to be installed in accordance with 426.28 or 427.22, as applicable.

Exception No. 2 to (4): In industrial establishments only, where the conditions of maintenance and supervision ensure that only qualified personnel are involved, an assured equipment grounding conductor program as specified in 590.6(B)(2) shall be permitted for only those receptacle outlets used to supply equipment that would create a greater hazard if power is interrupted or having a design that is not compatible with GFCI protection.

Changed from NEC 2008

210.8(B)(5) Sinks: This was revised to apply to patient bed locations in general and critical patient care areas in health care facilities.

Receptacles located around sinks at a dentist's or doctor's office and clinics are no longer excepted from GFCI protection.

NEC Language

(5) Sinks — where receptacles are installed within 1.8 m (6 ft) of the outside edge of the sink.

Exception No. 1 to (5): In industrial laboratories, receptacles used to supply equipment where removal of power would introduce a greater hazard shall be permitted to be installed without GFCI protection.

Exception No. 2 to (5): For receptacles located in patient bed locations of general care or critical care areas of health care facilities other than those covered under 210.8(B)(1), GFCI protection shall not be required.

Changed from NEC 2008

210.8(B)(6) Indoor wet locations: The NEC added a new requirement for GFCI protection in indoor wet locations.

NEC Language**(6) Indoor wet locations**

Indoor wet locations. Receptacles installed at other than dwelling unit indoor wet locations now require GFCI protection.

Changed from NEC 2008

210.8(B)(7) Locker rooms with associated showering facilities: The NEC added new requirement for GFCI protection in locker rooms having associated shower facilities.

Receptacles installed in locker rooms now require GFCI protection.

NEC Language**(7) Locker rooms with associated showering facilities****Highlight**

New provisions are included within 210.8(B)(7) that will require additional GFCI protection for all 125-volt, single-phase, 15- and 20-ampere receptacles.

Specifically, outlets installed in locker rooms with adjacent showering facilities will now be required to be GFCI protected.

The conditions in these areas are similar to the conditions found in bathrooms such as damp and/or wet flooring combined with the use of electrical devices such as electric shavers and electric hair dryers.

This combination obviously presents a significant electrical hazard to the occupants of these areas.

These areas have not been specifically addressed in previous versions of the Code and this section closes that gap.

Changed from NEC 2008

210.8(B)(8): The NEC added new provisions to require GFCI protection to all types of nondwelling unit **garages** where electrical diagnostic equipment, electrical hand tools, or portable lighting equipment are used, not just garages under the scope of Article 511.

NEC Language

(8) **Garages**, service bays, and similar areas where electrical diagnostic equipment, electrical hand tools, or portable lighting equipment are to be used.

Highlight

Along with the new requirements to add GFCI protection in locker rooms with showering facilities, section 210.8(B)(8) also adds requirements for garages, service bays, and similar areas.

The reason is that in most commercial and industrial buildings there are usually areas that are used for a wide variety of activities including servicing of automobiles, equipment, or company vehicles.

The floors are typically concrete and are usually susceptible to having fluids spilled on them as a result of these servicing activities.

In past Code versions, Article 511 was the only section that specifically covered commercial garages and repair shops. Depending on the design review or AHJ inspection process, it may not be clear that an area of a facility would be used for servicing activities that would involve the potential to spill fluids onto the floor.

This new requirement will require that all 125-volt, single-phase, 15- and 20-ampere receptacles that are used in these areas be GFCI protected.

210.12 Arc-Fault Circuit-Interrupter Protection

Changes made to this section address fire alarm circuiting, Type MC cables, concrete-encased raceways, and branch circuit extensions or modifications.

Changed from NEC 2008

210.12: Relocated the definition of **arc-fault circuit interrupter (AFCI)** to Article 100.

Type MC cable was added to the list of approved wiring methods permitted to protect the home run when a listed outlet branch-circuit Type AFCI device is installed at the first outlet box for AFCI protection of a branch circuit.

NEC Language

(A) **Dwelling Units.** All 120-volt, single phase, 15- and 20-ampere branch circuits supplying outlets installed in dwelling unit family rooms, dining rooms, living rooms, parlors, libraries, dens, bedrooms, sunrooms, recreation rooms, closets, hallways, or

similar rooms or areas shall be protected by a listed arc-fault circuit interrupter, combination-type, installed to provide protection of the branch circuit.

Informational Note No. 1: For information on types of arc-fault circuit interrupters, see UL 1699-1999, Standard for Arc-Fault Circuit Interrupters.

Informational Note No. 2: See 11.6.3(5) of NFPA 72-2010, National Fire Alarm and Signaling Code, for information related to secondary power supply requirements for smoke alarms installed in dwelling units.

Informational Note No. 3: See 760.41(B) and 760.121(B) for power-supply requirements for fire alarm systems.

Changed from NEC 2008

210.12(A) Exception No. 1: This was revised to permit outlet branch-circuit type AFCI devices and to permit Type MC cable as a wiring method.

NEC Language

Exception No. 1: If RMC, IMC, EMT, Type MC, or steel armored Type AC cables meeting the requirements of 250.118 and metal outlet and junction boxes are installed for the portion of the branch circuit between the branch-circuit overcurrent device and the first outlet, it shall be permitted to install an outlet branch-circuit type AFCI at the first outlet to provide protection for the remaining portion of the branch circuit.

Changed from NEC 2008

210.12(A) Exception 2: The NEC added a new exception permitting metal or nonmetallic conduit and tubing encased in concrete as a wiring method between overcurrent device and first outlet where outlet branch-circuit type AFCI device is installed

NEC Language

Exception No. 2: Where a listed metal or nonmetallic conduit or tubing is encased in not less than 50 mm (2 in.) of concrete for the portion of the branch circuit between the branch-circuit overcurrent device and the first outlet, it shall be permitted to install an outlet branch-circuit type AFCI at the first outlet to provide protection for the remaining portion of the branch circuit.

Changed from NEC 2008

210.12(A) Exception 3: This was revised to permit Type MC cable as a wiring method.

NEC Language

Exception No. 3: Where an individual branch circuit to a fire alarm system installed in accordance with 760.41(B) or 760.121(B) is installed in RMC, IMC, EMT, or steel-sheathed cable, Type AC or Type MC, meeting the requirements of 250.118, with metal outlet and junction boxes, AFCI protection shall be permitted to be omitted.

Changed from NEC 2008

210.12(B) Branch Circuit Extensions or Modifications — Dwelling Units: The NEC added a new requirement for AFCI protection where branch circuits are extended or modified.

NEC Language

(B) Branch Circuit Extensions or Modifications — Dwelling Units. In any of the areas specified in 210.12(A), where branch-circuit wiring is modified, replaced, or extended, the branch circuit shall be protected by one of the following:

- (1) A listed combination-type AFCI located at the origin of the branch circuit, or

- (2) A listed outlet branch-circuit type AFCI located at the first receptacle outlet of the existing branch circuit.

Changed from NEC 2008

210.12[B]: AFCI – Extensions or Modifications. The allowance for nonmetallic conduit or tubing encased in not less than 50 mm (2 in.) of concrete was added to the acceptable wiring methods for AFCI protection located at the first outlet of a branch circuit.

NEC Language

210.12[B] AFCI – Extensions or Modifications

210.19 Conductors — Minimum Ampacity and Size

Changed from NEC 2008

The **exception** allowing smaller neutral conductors for continuous loads was removed. The 2008 NEC introduced an allowance for sizing grounded conductors at 100 percent of continuous load, as opposed to the traditional 125 percent for both feeder circuits and branch circuits. Because this allowance applied to conductors that are grounded and not necessarily neutral, it could have resulted in a smaller grounded conductor in a corner grounded system than is typically required.

NEC Language

(A) Branch Circuits Not More Than 600 Volts.

(1) **General.** Branch-circuit conductors shall have an ampacity not less than the maximum load to be served. Where a branch circuit supplies continuous loads or any combination of continuous and noncontinuous loads, the minimum branch-circuit conductor size, before the application of any adjustment or correction factors, shall have an allowable ampacity not less than the noncontinuous load plus 125 percent of the continuous load.

Exception: If the assembly, including the overcurrent devices protecting the branch circuit(s), is listed for operation at 100 percent of its rating, the allowable ampacity of the branch circuit conductors shall be permitted to be not less than the sum of the continuous load plus the noncontinuous load.

Informational Note No. 1: See 310.15 for ampacity ratings of conductors.

Informational Note No. 2: See Part II of Article 430 for minimum rating of motor branch-circuit conductors.

Informational Note No. 3: See 310.15(A)(3) for temperature limitation of conductors.

Informational Note No. 4: Conductors for branch circuits as defined in Article 100, sized to prevent a voltage drop exceeding 3 percent at the farthest outlet of power, heating, and lighting loads, or combinations of such loads, and where the maximum total voltage drop on both feeders and branch circuits to the farthest outlet does not exceed 5 percent, provide reasonable efficiency of operation. See Informational Note No. 2 of 215.2(A)(3) for voltage drop on feeder conductors.

Changed from NEC 2008

210.19(A)(2) Branch Circuits with More than One Receptacle: The NEC revised the title to reflect requirement applies to branch circuit supplying multiple receptacles.

NEC Language

(2) **Branch Circuits with More than One Receptacle.** Conductors of branch circuits supplying more than one receptacle for cord-and-plug-connected portable loads shall have an ampacity of not less than the rating of the branch circuit.

210.24 Branch-Circuit Requirements — Summary

Changed from NEC 2008

This was revised to exclude receptacle circuits covered in 210.11(C)(3) from summary of branch-circuit requirements.

NEC Language

The requirements for circuits that have two or more outlets or receptacles, other than the receptacle circuits of 210.11(C)(1), (C)(2), and (C)(3), are summarized in Table 210.24. This table provides only a summary of minimum requirements. See 210.19, 210.20, and 210.21 for the specific requirements applying to branch circuits.

Circuit Rating	15 A	20 A	30 A	40 A	50 A
Conductors (min. size):					
Circuit wires ¹	14	12	10	8	6
Taps	14	14	14	12	12
Fixture wires and cords — see 240.5					
Overcurrent Protection	15 A	20 A	30 A	40 A	50 A
Outlet devices:					
Lampholders permitted	Any type	Any type	Heavy duty	Heavy duty	Heavy duty
Receptacle rating ²	15 max. A	15 or 20 A	30 A	40 or 50 A	50 A
Maximum Load	15 A	20 A	30 A	40 A	50 A
Permissible load	See 210.23(A)	See 210.23(A)	See 210.23(B)	See 210.23(C)	See 210.23(C)

¹These gauges are for copper conductors.
²For receptacle rating of cord-connected electric-discharge luminaires, see 410.62(C).

NEC 2011

210.52 Dwelling Unit Receptacle Outlets

Changed from NEC 2008

Listed receptacle outlet assemblies are now permitted to be installed on or in kitchen and bathroom countertops to serve as the required countertop receptacles.

NEC Language

This section provides requirements for 125-volt, 15- and 20-ampere receptacle outlets. The receptacles required by this section shall be in addition to any receptacle that is:

- (1) Part of a luminaire or appliance, or
- (2) Controlled by a wall switch in accordance with 210.70(A)(1), Exception No. 1, or
- (3) Located within cabinets or cupboards, or
- (4) Located more than 1.7 m (5½ ft) above the floor

Permanently installed electric baseboard heaters equipped with factory-installed receptacle outlets or outlets provided as a separate assembly by the manufacturer shall be permitted as the required outlet or outlets for the wall space utilized by such permanently installed heaters. Such receptacle outlets shall not be connected to the heater circuits.

Informational Note: Listed baseboard heaters include instructions that may not permit their installation below receptacle outlets.

Changed from NEC 2008

210.52(A) General Provisions: The NEC made changes to the wall spacing requirements to address fixed cabinets, and clarified the wall spacing requirements.

NEC Language

(A) General Provisions. In every kitchen, family room, dining room, living room, parlor, library, den, sunroom, bedroom, recreation room, or similar room or area of dwelling units, receptacle outlets shall be installed in accordance with the general provisions specified in 210.52(A)(1) through (A)(3).

(1) Spacing. Receptacles shall be installed such that no point measured horizontally along the floor line of any wall space is more than 1.8 m (6 ft) from a receptacle outlet.

(2) Wall Space. As used in this section, a wall space shall include the following:

Changed from NEC 2008

210.52(A)(2)(1): This was revised to exclude openings similar to doorways and to fixed cabinets from wall space determination.

NEC Language

(1) Any space 600 mm (2 ft) or more in width (including space measured around corners) and unbroken along the floor line by doorways and similar openings, fireplaces, and fixed cabinets

(2) The space occupied by fixed panels in exterior walls, excluding sliding panels

(3) The space afforded by fixed room dividers, such as freestanding bar-type counters or railings

(3) Floor Receptacles. Receptacle outlets in floors shall not be counted as part of the required number of receptacle outlets unless located within 450 mm (18 in.) of the wall.

Changed from NEC 2008

210.52(A)(4) Countertop Receptacles: Added a new requirement prohibiting countertop receptacle outlets from also being used as wall space receptacle outlets covered in 210.52(A).

NEC Language

(4) Countertop Receptacles. Receptacles installed for countertop surfaces as specified in 210.52(C) shall not be considered as the receptacles required by 210.52(A).

Changed from NEC 2008

210.52(C) Countertops: The NEC relocated the second paragraph to 210.52(C)(4), "Separate Spaces."

Multiple changes to this section deal with dwelling unit kitchen countertop receptacle requirements. Among others are a reorganization of the section, and added provisions for receptacles installed in an countertop, as opposed to above a countertop.

NEC Language

(C) **Countertops.** In kitchens, pantries, breakfast rooms, dining rooms, and similar areas of dwelling units, receptacle outlets for countertop spaces shall be installed in accordance with 210.52(C)(1) through (C)(5).

(1) **Wall Countertop Spaces.** A receptacle outlet shall be installed at each wall countertop space that is 300 mm (12 in.) or wider. Receptacle outlets shall be installed so that no point along the wall line is more than 600 mm (24 in.) measured horizontally from a receptacle outlet in that space.

Exception: Receptacle outlets shall not be required on a wall directly behind a range, counter-mounted cooking unit, or sink in the installation described in Figure 210.52(C)(1).

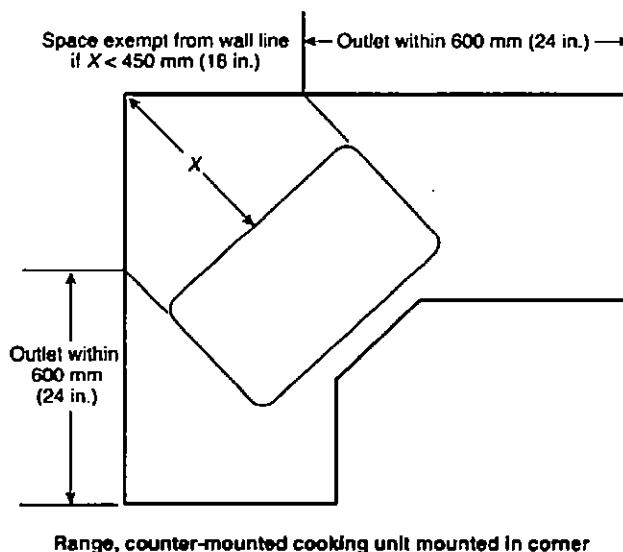
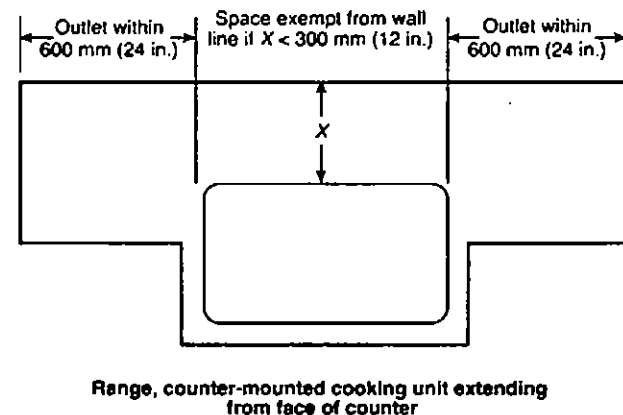

NEC 2011

Figure 210.52(C)(1) Determination of Area Behind a Range, or Counter-Mounted Cooking Unit or Sink

(2) **Island Countertop Spaces.** At least one receptacle shall be installed at each island countertop space with a long dimension of 600 mm (24 in.) or greater and a short dimension of 300 mm (12 in.) or greater.

Changed From NEC 2008**210.52 (C) (3) Peninsular Countertop Spaces**

Section 210.52 deals with receptacle outlets located in dwelling units.

These will be for 125-volt, 15- and 20-ampere receptacles.

The requirement for this section is that at least one receptacle outlet be installed at each peninsular countertop space with a long dimension of 24 in. or greater and a short dimension of 12 in. or greater. That distance is measured from the connecting edge.

The change is to the exception in 210.52(C)(3). This new exception will allow a receptacle installed in a wall countertop space to serve as the receptacle required for the peninsula countertop space. The requirements are that the spaces are contiguous (must be touching each other) and that the receptacle is located within 6 ft. of the outside edge of the peninsula.

NEC Language

(3) **Peninsular Countertop Spaces.** At least one receptacle outlet shall be installed at each peninsular countertop space with a long dimension of 600 mm (24 in.) or greater and a short dimension of 300 mm (12 in.) or greater. A peninsular countertop is measured from the connecting edge.

(4) **Separate Spaces.** Countertop spaces separated by rangetops, refrigerators, or sinks shall be considered as separate countertop spaces in applying the requirements of 210.52(C)(1). If a range, counter-mounted cooking unit, or sink is installed in an island or peninsular countertop and the depth of the countertop behind the range, counter-mounted cooking unit, or sink is less than 300 mm (12 in.), the range, counter-mounted cooking unit, or sink shall be considered to divide the countertop space into two separate countertop spaces. Each separate countertop space shall comply with the applicable requirements in 210.52(C).

Changed from NEC 2008

210.52 (C) (5): Listed receptacle outlet assemblies are now permitted to be installed on or the kitchen and bathroom countertops to serve as the required countertop receptacles.

NEC Language

(5) **Receptacle Outlet Location.** Receptacle outlets shall be located on or above, but not more than 500 mm (20 in.) above, the countertop. Receptacle outlet assemblies listed for the application shall be permitted to be installed in countertops. Receptacle outlets rendered not readily accessible by appliances fastened in place, appliance garages, sinks, or rangetops as covered in 210.52(C)(1), Exception, or appliances occupying dedicated space shall not be considered as these required outlets.

Changed from NEC 2008

210.52(C)(5): **Informational Note:** This was revised to permit receptacle outlets to be installed on, above, or in countertops.

NEC Language

210.52(C)(5) **Informational Note:** The NEC added a new informational note referencing 406.5(E) for receptacles installed in countertops.

Informational Note: See 406.5(E) for requirements for installation of receptacles in countertops.

Exception to (5): To comply with the conditions specified in (1) or (2), receptacle outlets shall be permitted to be mounted not more than 300 mm (12 in.) below the countertop. Receptacles mounted below a countertop in accordance with this exception shall not be located where the countertop extends more than 150 mm (6 in.) beyond its support base.

(1) Construction for the physically impaired

(2) On island and peninsular countertops where the countertop is flat across its entire surface (no backsplashes, dividers, etc.) and there are no means to mount a receptacle within 500 mm (20 in.) above the countertop, such as an overhead cabinet

Changed from NEC 2008

210.52(D) **Bathrooms:** This was revised to permit receptacle outlets to be installed on, above, or in countertops.

NEC Language

(D) **Bathrooms.** In dwelling units, at least one receptacle outlet shall be installed in bathrooms within 900 mm (3 ft) of the outside edge of each basin. The receptacle outlet shall be located on a wall or partition that is adjacent to the basin or basin countertop, located on the countertop, or installed on the side or face of the basin cabinet not more than 300 mm (12 in.) below the countertop. Receptacle outlet assemblies listed for the application shall be permitted to be installed in the countertop.

Changed from NEC 2008

210.52(D) **Informational Note:** The NEC added a new informational note referencing 406.5(E) for receptacles installed in countertops.

NEC Language

Informational Note: See 406.5(E) for requirements for installation of receptacles in countertops.

Changed from NEC 2008

210.52(E)(3) **Balconies, Decks, and Porches:** Receptacle outlet is required at all balconies, decks, and porches that are accessible from inside of a dwelling unit, regardless of the size of the balcony, deck, or porch.

NEC Language

(E) **Outdoor Outlets.** Outdoor receptacle outlets shall be installed in accordance with (E)(1) through (E)(3). [See 210.8(A)(3).]

(3) **Balconies, Decks, and Porches.** Balconies, decks, and porches that are accessible from inside the dwelling unit shall have at least one receptacle outlet installed within the perimeter of the balcony, deck, or porch. The receptacle shall not be located more than 2.0 m (6½ ft) above the balcony, deck, or porch surface.

The following text was deleted:

~~**Exception to [3]:** Balconies, decks or porches with a usable area of less than 1.86 m² (20 ft²) are not required to have a receptacle installed.~~

210.52[G] – Basements, Garages, and Accessory Buildings

Changed from NEC 2008

210.52(G) **Balconies, Decks, and Porches:** At least one receptacle outlet is required to be installed in all basements, garages, or accessory buildings with electric power.

NEC Language

(G) **Basements, Garages, and Accessory Buildings.** For a one-family dwelling, the following provisions shall apply:

Changed from NEC 2008

210.52(G)(1): This was revised to include accessory buildings.

NEC Language

(1) At least one receptacle outlet, in addition to those for specific equipment, shall be installed in each basement, in each attached garage, and in each detached garage or accessory building with electric power.

(2) Where a portion of the basement is finished into one or more habitable rooms, each separate unfinished portion shall have a receptacle outlet installed in accordance with this section.

Changed from NEC 2008

210.52(I) **Foyers:** Receptacle outlet is now required in dwelling unit foyers under specific conditions.

NEC Language

(I) **Foyers.** Foyers that are not part of a hallway in accordance with 210.52(H) and that have an area that is greater than 5.6 m² (60 ft²) shall have a receptacle(s) located in each wall space 900 mm (3 ft) or more in width and unbroken by doorways, floor-to-ceiling windows, and similar openings.

II. Branch-Circuit Load Calculations

220.5 Calculations

NEC Language

(A) **Voltages.** Unless other voltages are specified, for purposes of calculating branch-circuit and feeder loads, nominal system voltages of 120, 120/240, 208Y/120, 240, 347, 480Y/277, 480, 600Y/347, and 600 volts shall be used.

Changed from NEC 2008

220.5(B) **Fractions of an Ampere:** This was revised to clarify application of "rounding" requirement.

NEC Language

(B) **Fractions of an Ampere.** Calculations shall be permitted to be rounded to the nearest whole ampere, with decimal fractions smaller than 0.5 dropped.

220.14 Other Loads — All Occupancies.

NEC Language

In all occupancies, the minimum load for each outlet for general-use receptacles and outlets not used for general illumination shall not be less than that calculated in 220.14(A) through (L), the loads shown being based on nominal branch-circuit voltages.

Exception: The loads of outlets serving switchboards and switching frames in telephone exchanges shall be waived from the calculations.

(A) **Specific Appliances or Loads.** An outlet for a specific appliance or other load not covered in 220.14(B) through (L) shall be calculated based on the ampere rating of the appliance or load served.

Changed from NEC 2008

220.14(B) **Electric Dryers and Electric Cooking Appliances in Dwelling Units:** This was revised to clarify that the requirement applies only to dwelling units.

NEC Language

(B) **Electric Dryers and Electric Cooking Appliances in Dwelling Units.** Load calculations shall be permitted as specified in 220.54 for electric dryers and in 220.55 for electric ranges and other cooking appliances.

220.18 Maximum Loads

NEC Language

The total load shall not exceed the rating of the branch circuit, and it shall not exceed the maximum loads specified in 220.18(A) through (C) under the conditions specified therein.

(A) **Motor-Operated and Combination Loads.** Where a circuit supplies only motor-operated loads, Article 430 shall apply. Where a circuit supplies only air-conditioning equipment, refrigerating equipment, or both, Article 440 shall apply. For circuits supplying loads consisting of motor-operated utilization equipment that is fastened in place and has a motor larger than 1/2 hp in combination with other loads, the total calculated load shall be based on 125 percent of the largest motor load plus the sum of the other loads.

Changed from NEC 2008

220.18(B) **Inductive and LED Lighting Loads:** This was revised to include LED lighting loads.

NEC Language

(B) **Inductive and LED Lighting Loads.** For circuits supplying lighting units that have ballasts, transformers, autotransformers, or LED drivers, the calculated load shall be based on the total ampere ratings of such units and not on the total watts of the lamps.

(C) **Range Loads.** It shall be permissible to apply demand factors for range loads in accordance with Table 220.55, including Note 4.

III. Feeder and Service Load Calculations

220.43 Show-Window and Track Lighting

NEC Language

(A) **Show Windows.** For show-window lighting, a load of not less than 660 volt-amperes/linear meter or 200 volt-amperes/linear foot shall be included for a show window, measured horizontally along its base.

Informational Note: See 220.14(G) for branch circuits supplying show windows.

(B) **Track Lighting.** For track lighting in other than dwelling units or guest rooms or guest suites of hotels or motels, an additional load of 150 volt-amperes shall be included for every 600 mm (2 ft) of lighting track or fraction thereof. Where multicircuit track is installed, the load shall be considered to be divided equally between the track circuits.

Changed from NEC 2008

220.43(B) Exception: The NEC added a new exception permitting calculation of track lighting load to be based on rating of a device limiting current to the track.
--

NEC Language

Exception: If the track lighting is supplied through a device that limits the current to the track, the load shall be permitted to be calculated based on the rating of the device used to limit the current.

IV. Optional Feeder and Service Load Calculations

220.86 Schools

NEC Language

The calculation of a feeder or service load for schools shall be permitted in accordance with Table 220.86 in lieu of Part III of this article where equipped with electric space heating, air conditioning, or both. The connected load to which the demand factors of Table 220.86 apply shall include all of the interior and exterior lighting, power, water heating, cooking, other loads, and the larger of the air-conditioning load or space-heating load within the building or structure.

Feeders and service conductors whose calculated load is determined by this optional calculation shall be permitted to have the neutral load determined by 220.61. Where the building or structure load is calculated by this optional method, feeders within the building or structure shall have ampacity as permitted in Part III of this article; however, the ampacity of an individual feeder shall not be required to be larger than the ampacity for the entire building.

This section does not apply to portable classroom buildings.

Changed from NEC 2008

Table 220.86: This was revised to clarify that demand factors are applied incrementally to the connected load.
--

Connected Load		Demand Factor (Percent)
First 33 VA/m ² Plus.	(3 VA/ft ²) at	100
Over 33 through 220 VA/m ² Plus.	(3 through 20 VA/ft ²) at	75
Remainder over 220 VA/m ²	(20 VA/ft ²) at	25

2011 NEC

V. Farm Load Calculations

220.102 Farm Loads — Buildings and Other Loads

NEC Language

(A) **Dwelling Unit.** The feeder or service load of a farm dwelling unit shall be calculated in accordance with the provisions for dwellings in Part III or IV of this article. Where the dwelling has electric heat and the farm has electric grain-drying systems, Part IV of this article shall not be used to calculate the dwelling load where the dwelling and farm loads are supplied by a common service.

(B) **Other Than Dwelling Unit.** Where a feeder or service supplies a farm building or other load having two or more separate branch circuits, the load for feeders, service conductors, and service equipment shall be calculated in accordance with demand factors not less than indicated in Table 220.102.

Changed from NEC 2008

Table 220.102: This was revised to clarify that it is the greater of the three load descriptions that is to be used for calculating load.

Ampere Load at 240 Volts Maximum	Demand Factor (%)
The greater of the following: All loads that are expected to operate simultaneously, or 125 percent of the full load current of the largest motor, or First 60 amperes of the load	100
Next 60 amperes of all other loads	50
Remainder of other loads	25

2011 NEC

Article 225 — Outside Branch Circuits and Feeders

Article 225 covers requirements for outside branch circuits and feeders run on or between buildings, structures, or poles on the premises; and electrical equipment and wiring for the supply of utilization equipment that is located on or attached to the outside of buildings, structures, or poles.

This article provides requirements unique to the installation of feeders and branch circuits on the outside (overhead and underground) of buildings and structures. These circuits may be supplying specific items of electrical equipment or they may be the power supply to another building or structure.

The power source for the outside feeders and/or branch circuits may be delivered to a site by a utility and subsequently distributed throughout a multi-building industrial or institutional campus as feeder or branch circuits; the power source may be a separately derived system such as an emergency or standby system, or the power source may be a combination of the two.

This article covers sources rated 600 volts, nominal or less and sources rated over 600 volts, nominal. These requirements are to be used in addition to the general requirements for branch circuits and feeders in Articles 210 and 215.

Informational Note: For additional information on wiring over 600 volts, see ANSI C2-2007, National Electrical Safety Code.

225.2 Definition

Changed from NEC 2008

Article 225 added a new requirements for branch circuits and feeder supply systems and equipment over 600 volts.

225.2 Substation: The NEC added a new definition of “substation.”

NEC Language

Substation. An enclosed assemblage of equipment (e.g., switches, circuit breakers, buses, and transformers) under the control of qualified persons, through which electric energy is passed for the purpose of switching or modifying its characteristics.

I. General

225.8 Calculation of Loads 600 Volts, Nominal, or Less

Changed from NEC 2008

225.8: The NEC added a new requirement for calculating loads on outside branch circuit and feeders rated 600 volts, nominal or less.

NEC Language

(A) **Branch Circuits.** The load on outdoor branch circuits shall be as determined by 220.10.

(B) **Feeders.** The load on outdoor feeders shall be as determined by Part III of Article 220.

225.18 Clearance for Overhead Conductors and Cables

NEC Language

Overhead spans of open conductors and open multiconductor cables of not over 600 volts, nominal, shall have a clearance of not less than the following:

- (1) 3.0 m (10 ft) — above finished grade, sidewalks, or from any platform or projection from which they might be reached where the voltage does not exceed 150 volts to ground and accessible to pedestrians only
- (2) 3.7 m (12 ft) — over residential property and driveways, and those commercial areas not subject to truck traffic where the voltage does not exceed 300 volts to ground
- (3) 4.5 m (15 ft) — for those areas listed in the 3.7-m (12-ft) classification where the voltage exceeds 300 volts to ground
- (4) 5.5 m (18 ft) — over public streets, alleys, roads, parking areas subject to truck traffic, driveways on other than residential property, and other land traversed by vehicles, such as cultivated, grazing, forest, and orchard.

Changed from NEC 2008

New clearance requirements were added for overhead conductors installed over railway tracks.

NEC Language

Overhead spans of open conductors and open multiconductor cables of not over 600 volts, nominal, shall have a clearance of not less than 7.5 m (24.5 ft) over track rails of railroads.

Changed from NEC 2008

225.18(5): The NEC added a new requirement for minimum clearance of conductors or cables passing railroad tracks.

NEC Language

- (5) 7.5 m (24.5 ft) — over track rails of railroads

225.22 Raceways on Exterior Surfaces of Buildings or Other Structures

Changed from NEC 2008

225.22: This was revised by replacing "raintight" with "suitable for wet locations" for consistency with similar requirements.

NEC Language

Raceways on exteriors of buildings or other structures shall be arranged to drain and shall be suitable for use in wet locations.

225.27 Raceway Seal

Changed from NEC 2008

225.27: The NEC added a new requirement for sealing raceways entering buildings from underground distribution systems.

A raceway seal is required at outside underground branch circuit and feeder raceways entering a building.

Conduits or raceways required to be sealed or plugged at either or both ends.

NEC Language

Where a raceway enters a building or structure from an underground distribution system, it shall be sealed in accordance with 300.5(G). Spare or unused raceways shall also be sealed. Sealants shall be identified for use with the cable insulation, shield, or other components.

II. Buildings or Other Structures Supplied by a Feeder(s) or Branch Circuit(s)

Changed from NEC 2008

225 Part II: The Title was revised to clarify applicability.

225.30 Number of Supplies

Changed from NEC 2008

225.30: This was revised to cover branch circuits and feeders installed from a building or structure back to the building or structure that is the original source of power.

Where more than one building (same property, under single management) exist, each additional building shall be supplied by only one feeder or branch circuit.

Where a branch circuit or feeder originates in the additional buildings, only one feed or branch circuit is permitted to supply power back to the original building.

NEC Language

A building or other structure that is served by a branch circuit or feeder on the load side of a service disconnecting means shall be supplied by only one feeder or branch circuit unless permitted in 225.30(A) through (E). For the purpose of this section, a multiwire branch circuit shall be considered a single circuit.

Where a branch circuit or feeder originates in these additional buildings or other structures, only one feeder or branch circuit shall be permitted to supply power back to the original building or structure, unless permitted in 225.30(A) through (E).

For the purpose of this section, a multiwire branch circuit shall be considered a single circuit.

225.52 Disconnecting Means

Changed from NEC 2008

225.52: This was revised to include new requirements for disconnecting means in branch circuits and feeders rated over 600 volts. Includes requirement formerly located in 225.53.

(A) **Location.** A building or structure disconnecting means shall be located in accordance with 225.32, or it shall be electrically operated by a similarly located remote-control device.

(B) **Type.** Each building or structure disconnect shall simultaneously disconnect all ungrounded supply conductors it controls and shall have a fault-closing rating not less than the maximum available short-circuit current available at its supply terminals.

Changed from NEC 2008

225.52(B) Exception: The NEC added a new exception not requiring simultaneous disconnection of ungrounded conductors where fused cutouts are used as disconnecting means.

NEC Language

Exception: Where the individual disconnecting means consists of fused cutouts, the simultaneous disconnection of all ungrounded supply conductors shall not be required if there is a means to disconnect the load before opening the cutouts. A permanent legible sign shall be installed adjacent to the fused cutouts indicating the above requirement.

225.56 Inspections and Tests

Changed from NEC 2008

225.56: The NEC added new requirements for inspection and testing of equipment in **branch circuits and feeders rated over 600 volts.**

NEC Language

(A) **Pre-Energization and Operating Tests.** The complete electrical system shall be performance tested when first installed on-site. Each protective, switching, and control circuit shall be adjusted in accordance with the recommendations of the protective device study and tested by actual operation using current injection or equivalent methods as necessary to ensure that each and every such circuit operates correctly to the satisfaction of the authority having jurisdiction.

- (1) **Instrument Transformers.** All instrument transformers shall be tested to verify correct polarity and burden.
- (2) **Protective Relays.** Each protective relay shall be demonstrated to operate by injecting current or voltage, or both, at the associated instrument transformer output terminal and observing that the associated switching and signaling functions occur correctly and in proper time and sequence to accomplish the protective function intended.
- (3) **Switching Circuits.** Each switching circuit shall be observed to operate the associated equipment being switched.
- (4) **Control and Signal Circuits.** Each control or signal circuit shall be observed to perform its proper control function or produce a correct signal output.
- (5) **Metering Circuits.** All metering circuits shall be verified to operate correctly from voltage and current sources, similarly to protective relay circuits.
- (6) **Acceptance Tests.** Complete acceptance tests shall be performed, after the station installation is completed, on all assemblies, equipment, conductors, and control and protective systems, as applicable, to verify the integrity of all the systems.
- (7) **Relays and Metering Utilizing Phase Differences.** All relays and metering that use phase differences for operation shall be verified by measuring phase angles at the relay under actual load conditions after operation commences.

(B) Test Report. A test report covering the results of the tests required in 225.56(A) shall be delivered to the authority having jurisdiction prior to energization.

Informational Note: For acceptance specifications, see NETA ATS-2007, Acceptance Testing Specifications for Electrical Power Distribution Equipment and Systems, published by the International Electrical Testing Association.

225.70 Substations

Changed from NEC 2008

225.70: The NEC added new requirement for substations used in feeders rated over 600 volts.

NEC Language

(A) Warning Signs.

(1) General. A permanent, legible warning notice carrying the wording "DANGER — HIGH VOLTAGE" shall be placed in a conspicuous position in the following areas:

- (a) At all entrances to electrical equipment vaults and electrical equipment rooms, areas, or enclosures
- (b) At points of access to conductors on all high-voltage conduit systems and cable systems
- (c) On all cable trays containing high-voltage conductors with the maximum spacing of warning notices not to exceed 3 m (10 ft.)

(2) Isolating Equipment. Permanent legible signs shall be installed at isolating equipment warning against operation while carrying current, unless the equipment is interlocked so that it cannot be operated under load.

(3) Fuse Locations. Suitable warning signs shall be erected in a conspicuous place adjacent to fuses, warning operators not to replace fuses while the circuit is energized.

(4) Backfeed. The following steps shall be taken where the possibility of backfeed exists:

- (a) Each group-operated isolating switch or disconnecting means shall bear a warning notice to the effect that contacts on either side of the device might be energized.
- (b) A permanent, legible, single-line diagram of the station switching arrangement, clearly identifying each point of connection to the high-voltage section, shall be provided in a conspicuous location within sight of each point of connection.

(5) Metal-Enclosed and Metal-Clad Switchgear. Where metal-enclosed switchgear is installed, the following steps shall be taken:

- (a) A permanent, legible, single-line diagram of the switchgear shall be provided in a readily visible location within sight of the switchgear, and this diagram shall clearly identify interlocks, isolation means, and all possible sources of voltage to the installation under normal or emergency conditions, including all equipment contained in each cubicle, and the marking on the switchgear shall cross-reference the diagram.

Exception to (a): Where the equipment consists solely of a single cubicle or metal-enclosed unit substation containing only one set of high-voltage switching devices, diagrams shall not be required.

(b) Permanent, legible signs shall be installed on panels or doors that provide access to live parts over 600 volts and shall carry the wording "DANGER — HIGH VOLTAGE" to warn of the danger of opening while energized.

(c) Where the panel provides access to parts that can only be de-energized and visibly isolated by the serving utility, the warning shall include that access is limited to the serving utility or following an authorization of the serving utility.

Article 230 — Services

Article 230 covers the installation requirements for service conductors and equipment. It is essential to know where the service begins and where it ends when applying the provisions of this article.

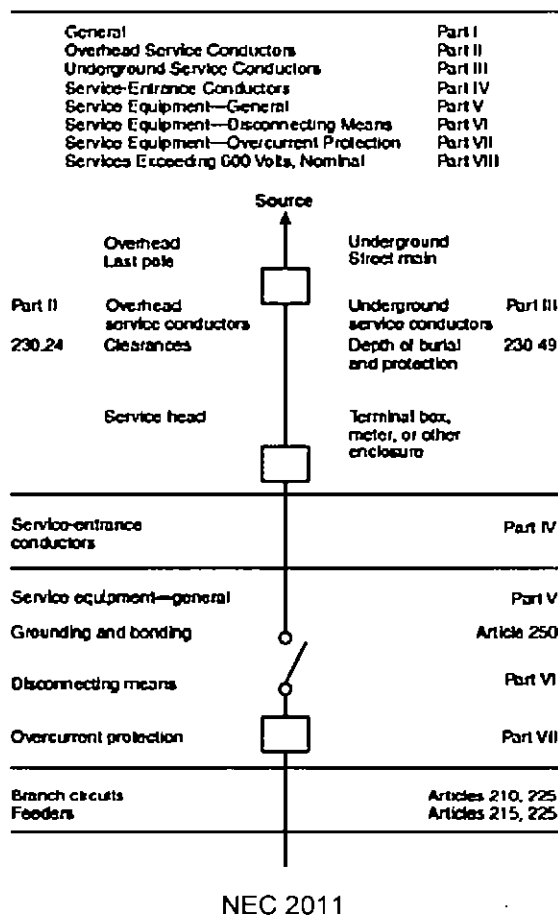

Changed from NEC 2008

230: The NEC enacted global changes for correlation with revised definitions of service conductor, overhead; service conductor, underground; service drop, and service lateral.

I. General

230.6 Conductors Considered Outside the Building

NEC Language

Conductors shall be considered outside of a building or other structure under any of the following conditions:

- (1) Where installed under not less than 50 mm (2 in.) of concrete beneath a building or other structure

- (2) Where installed within a building or other structure in a raceway that is encased in concrete or brick not less than 50 mm (2 in.) thick
- (3) Where installed in any vault that meets the construction requirements of Article 450, Part III
- (4) Where installed in conduit and under not less than 450 mm (18 in.) of earth beneath a building or other structure

Changed from NEC 2008

230.6(5): The NEC added a new condition that service conductors installed in a mast and run through eave of building be considered as outside.

NEC Language

(5) Where installed in overhead service masts on the outside surface of the building traveling through the eave of that building to meet the requirements of 230.24

II. Overhead Service Conductors

230.24 Clearances

NEC Language

Overhead service conductors shall not be readily accessible and shall comply with 230.24(A) through (E) for services not over 600 volts, nominal.

(A) Above Roofs. Conductors shall have a vertical clearance of not less than 2.5 m (8 ft) above the roof surface. The vertical clearance above the roof level shall be maintained for a distance of not less than 900 mm (3 ft) in all directions from the edge of the roof.

Exception No. 1: The area above a roof surface subject to pedestrian or vehicular traffic shall have a vertical clearance from the roof surface in accordance with the clearance requirements of 230.24(B).

Exception No. 2: Where the voltage between conductors does not exceed 300 and the roof has a slope of 100 mm in 300 mm (4 in. in 12 in.) or greater, a reduction in clearance to 900 mm (3 ft) shall be permitted.

Exception No. 3: Where the voltage between conductors does not exceed 300, a reduction in clearance above only the overhanging portion of the roof to not less than 450 mm (18 in.) shall be permitted if (1) not more than 1.8 m (6 ft) of overhead service conductors, 1.2 m (4 ft) horizontally, pass above the roof overhang, and (2) they are terminated at a through-the-roof raceway or approved support.

Informational Note: See 230.28 for mast supports.

Exception No. 4: The requirement for maintaining the vertical clearance 900 mm (3 ft) from the edge of the roof shall not apply to the final conductor span where the service drop is attached to the side of a building.

Changed from NEC 2008

230.24(A) **Exception No. 5:** The NEC added a new condition for reduced overhead clearance where the roof area is guarded or isolated and the voltage between conductors is 300 volts or less.

Service conductors are generally required to have a vertical clearance of not less than 2.5 m (8 ft) above the roof surface.

A reduction of clearance for overhead service conductors above a roof of 900 mm (3 ft) is permitted where the roof area is guarded or isolated.

NEC Language

Exception No. 5: Where the voltage between conductors does not exceed 300 and the roof area is guarded or isolated, a reduction in clearance to 900 mm (3 ft) shall be permitted.

(B) Vertical Clearance for Overhead Service Conductors. Overhead service conductors, where not in excess of 600 volts, nominal, shall have the following minimum clearance from final grade:

(1) **3.0 m (10 ft)** — at the electrical service entrance to buildings, also at the lowest point of the drip loop of the building electrical entrance, and above areas or sidewalks accessible only to pedestrians, measured from final grade or other accessible surface only for service-drop cables supported on and cabled together with a grounded bare messenger where the voltage does not exceed 150 volts to ground

(2) **3.7 m (12 ft)** — over residential property and driveways, and those commercial areas not subject to truck traffic where the voltage does not exceed 300 volts to ground

(3) **4.5 m (15 ft)** — for those areas listed in the 3.7-m (12-ft) classification where the voltage exceeds 300 volts to ground

(4) **5.5 m (18 ft)** — over public streets, alleys, roads, parking areas subject to truck traffic, driveways on other than residential property, and other land such as cultivated, grazing, forest, and orchard

(C) Clearance from Building Openings. See 230.9.

(D) Clearance from Swimming Pools. See 680.8.

Changed from NEC 2008

230.24(E): The NEC added a new requirement for clearance from communications wires and cables to be as specified in 800.44(A)(4).

NEC Language

(E) Clearance from Communication Wires and Cables. Clearance from communication wires and cables shall be in accordance with 800.44(A)(4).

III. Underground Service Conductors

230.32 Protection Against Damage

Changed from NEC 2008

230.32: This was revised for consistency with the use of terms related to service conductors and to provide a reference to service conductors entering other structures.

NEC Language

Underground service conductors shall be protected against damage in accordance with 300.5. Service conductors entering a building or other structure shall be installed in accordance with 230.6 or protected by a raceway wiring method identified in 230.43.

IV. Service-Entrance Conductors

230.40 Number of Service-Entrance Conductor Sets

NEC Language

Each service drop, set of overhead service conductors, set of underground service conductors, or service lateral shall supply only one set of service-entrance conductors.

Changed from NEC 2008

230.40 Exception No. 1: This was revised to include a requirement covering identification of disconnecting means locations per 230.2(E), or to have identification provided in an approved location.

NEC Language

Exception No. 1: A building with more than one occupancy shall be permitted to have one set of service-entrance conductors for each service, as defined in 230.2, run to each occupancy or group of occupancies. If the number of service disconnect locations for any given classification of service does not exceed six, the requirements of 230.2(E) shall apply at each location. If the number of service disconnect locations exceeds six for any given supply classification, all service disconnect locations for all supply characteristics, together with any branch circuit or feeder supply sources, if applicable, shall be clearly described using suitable graphics or text, or both, on one or more plaques located in an approved, readily accessible location(s) on the building or structure served and as near as practicable to the point(s) of attachment or entry(ies) for each service drop or service lateral, and for each set of overhead or underground service conductors.

Exception No. 2: Where two to six service disconnecting means in separate enclosures are grouped at one location and supply separate loads from one service drop, set of overhead service conductors, set of underground service conductors, or service lateral, one set of service-entrance conductors shall be permitted to supply each or several such service equipment enclosures.

Exception No. 3: A single-family dwelling unit and its accessory structures shall be permitted to have one set of service-entrance conductors run to each from a single service drop, set of overhead service conductors, set of underground service conductors, or service lateral.

Changed from NEC 2008

230.40 Exception No. 4: This was revised to include multiple occupancy buildings.

NEC Language

Exception No. 4: Two-family dwellings, multifamily dwellings, and multiple occupancy buildings shall be permitted to have one set of service-entrance conductors installed to supply the circuits covered in 210.25.

Exception No. 5: One set of service-entrance conductors connected to the supply side of the normal service disconnecting means shall be permitted to supply each or several systems covered by 230.82(5) or 230.82(6).

230.42 Minimum Size and Rating

Changed from NEC 2008

Service grounded conductor(s) can be sized and rated at 100 percent of the continuous and noncontinuous load when not connected to an overcurrent device.

230.42 Exception: The NEC added a new exception permitting grounded conductors to be sized at 100% of the continuous and noncontinuous load.

NEC Language

(A) **General.** The ampacity of the service-entrance conductors before the application of any adjustment or correction factors shall not be less than either 230.42(A)(1) or (A)(2). Loads shall be determined in accordance with Part III, IV, or V of Article 220, as applicable. Ampacity shall be determined from 310.15. The maximum allowable current of busways shall be that value for which the busway has been listed or labeled.

(1) The sum of the noncontinuous loads plus 125 percent of continuous loads

Exception: Grounded conductors that are not connected to an overcurrent device shall be permitted to be sized at 100 percent of the continuous and noncontinuous load.

(2) The sum of the noncontinuous load plus the continuous load if the service-entrance conductors terminate in an overcurrent device where both the overcurrent device and its assembly are listed for operation at 100 percent of their rating

230.43 Wiring Methods for 600 Volts, Nominal, or Less**Changed from NEC 2008**

230.43: This was revised to permit all rigid nonmetallic raceways and nonmetallic underground conductors in conduit (NUCC) as service wiring methods.

NEC Language

Service-entrance conductors shall be installed in accordance with the applicable requirements of this Code covering the type of wiring method used and shall be limited to the following methods:

- (1) Open wiring on insulators
- (2) Type IGS cable
- (3) Rigid metal conduit
- (4) Intermediate metal conduit
- (5) Electrical metallic tubing
- (6) Electrical nonmetallic tubing (ENT)
- (7) Service-entrance cables
- (8) Wireways
- (9) Busways
- (10) Auxiliary gutters
- (11) Rigid polyvinyl chloride conduit (PVC)
- (12) Cablebus
- (13) Type MC cable
- (14) Mineral-insulated, metal-sheathed cable
- (15) Flexible metal conduit not over 1.8 m (6 ft) long or liquidtight flexible metal conduit not over 1.8 m (6 ft) long between raceways, or between raceway and service equipment, with equipment bonding jumper routed with the flexible metal conduit or the liquidtight flexible metal conduit according to the provisions of 250.102(A), (B), (C), and (E)

- (16) Liquidtight flexible nonmetallic conduit
- (17) High density polyethylene conduit (HDPE)
- (18) Nonmetallic underground conduit with conductors (NUCC)
- (19) Reinforced thermosetting resin conduit (RTRC)

230.44 Cable Trays

Changed from NEC 2008

230.44: This was revised to specify wiring methods permitted in cable trays and to incorporate the labeling requirements previously located in the exception.

Cable trays containing service conductors shall be identified with permanently affixed labels with the wording **Service-Entrance Conductors**.

Labeling requirements for cable trays containing service conductors was move from exception to mandatory language.

A list of permitted wiring methods for cable trays containing service conductors was added.

NEC Language

Cable tray systems shall be permitted to support service-entrance conductors. Cable trays used to support service-entrance conductors shall contain only service-entrance conductors and shall be limited to the following methods:

- (1) Type SE cable
- (2) Type MC cable
- (3) Type MI cable
- (4) Type IGS cable
- (5) Single thermoplastic-insulated conductors 1/0 and larger with CT rating

Such cable trays shall be identified with permanently affixed labels with the wording "Service-Entrance Conductors." The labels shall be located so as to be visible after installation and placed so that the service-entrance conductors are able to be readily traced through the entire length of the cable tray.

Exception: Conductors, other than service-entrance conductors, shall be permitted to be installed in a cable tray with service-entrance conductors, provided a solid fixed barrier of a material compatible with the cable tray is installed to separate the service-entrance conductors from other conductors installed in the cable tray.

230.50 Protection Against Physical Damage

NEC Language

(A) **Underground Service-Entrance Conductors.** Underground service-entrance conductors shall be protected against physical damage in accordance with 300.5.

(B) **All Other Service-Entrance Conductors.** All other service-entrance conductors, other than underground service entrance conductors, shall be protected against physical damage as specified in 230.50(B)(1) or (B)(2).

Changed from NEC 2008

230.50(B)(1) Service-Entrance Cables: This was revised to include reinforced thermosetting resin conduit (RTRC).

NEC Language

(1) **Service-Entrance Cables.** Service-entrance cables, where subject to physical damage, shall be protected by any of the following:

- (1) Rigid metal conduit
- (2) Intermediate metal conduit
- (3) Schedule 80 PVC conduit
- (4) Electrical metallic tubing
- (5) Reinforced thermosetting resin conduit (RTRC)
- (6) Other approved means

(2) **Other Than Service-Entrance Cables.** Individual open conductors and cables, other than service-entrance cables, shall not be installed within 3.0 m (10 ft) of grade level or where exposed to physical damage.

Exception: Type MI and Type MC cable shall be permitted within 3.0 m (10 ft) of grade level where not exposed to physical damage or where protected in accordance with 300.5(D).

230.54 Overhead Service Locations**Changed from NEC 2008**

230.54(A) Service Head: This was revised by deleting reference to 314.15 and replacing it with the requirement that service heads be listed for use in wet locations.

NEC Language

(A) **Service Head.** Service raceways shall be equipped with a service head at the point of connection to service-drop or overhead service conductors. The service head shall be listed for use in wet locations.

Changed from NEC 2008

230.54(B) Service-Entrance Cables Equipped with Service Head or Gooseneck: This was revised by deleting reference to 314.15 and replacing it with the requirement that service heads be listed for use in wet locations.

NEC Language

(B) **Service-Entrance Cables Equipped with Service Head or Gooseneck.** Service-entrance cables shall be equipped with a service head. The service head shall be listed for use in wet locations.

Exception: Type SE cable shall be permitted to be formed in a gooseneck and taped with a self-sealing weather-resistant thermoplastic.

V. Service Equipment — General**230.66 Marking****Changed from NEC 2008**

230.66: This was revised to include the requirement that all service equipment be listed.

NEC Language

Service equipment rated at 600 volts or less shall be marked to identify it as being suitable for use as service equipment. All service equipment shall be listed. Individual meter socket enclosures shall not be considered service equipment.

VI. Service Equipment — Disconnecting Means

230.72 Grouping of Disconnects

NEC Language

(A) **General.** The two to six disconnects as permitted in 230.71 shall be grouped. Each disconnect shall be marked to indicate the load served.

Changed from NEC 2008

230.72(A) **Exception:** This was revised to require a plaque to identify the location of the remote disconnecting means.

NEC Language

Exception: One of the two to six service disconnecting means permitted in 230.71, where used only for a water pump also intended to provide fire protection, shall be permitted to be located remote from the other disconnecting means. If remotely installed in accordance with this exception, a plaque shall be posted at the location of the remaining grouped disconnects denoting its location.

230.77 Indicating

Changed from NEC 2008

230.77: This was revised to clarify that "open" is "off" position and "closed" position is "on" position.

The service disconnecting means shall plainly indicate whether it is in the open (off) or closed (on) position.

230.82 Equipment Connected to the Supply Side of Service Disconnect

NEC Language

Only the following equipment shall be permitted to be connected to the supply side of the service disconnecting means:

- (1) Cable limiters or other current-limiting devices.
- (2) Meters and meter sockets nominally rated not in excess of 600 volts, provided all metal housings and service enclosures are grounded in accordance with Part VII and bonded in accordance with Part V of Article 250.
- (3) Meter disconnect switches nominally rated not in excess of 600 volts that have a short-circuit current rating equal to or greater than the available short-circuit current, provided all metal housings and service enclosures are grounded in accordance with Part VII and bonded in accordance with Part V of Article 250. A meter disconnect switch shall be capable of interrupting the load served.
- (4) Instrument transformers (current and voltage), impedance shunts, load management devices, surge arresters, and Type 1 surge-protective devices.
- (5) Taps used only to supply load management devices, circuits for standby power systems, fire pump equipment, and fire and sprinkler alarms, if provided with service

equipment and installed in accordance with requirements for service-entrance conductors.

(6) Solar photovoltaic systems, fuel cell systems, or interconnected electric power production sources.

(7) Control circuits for power-operable service disconnecting means, if suitable overcurrent protection and disconnecting means are provided.

(8) Ground-fault protection systems or Type 2 surge-protective devices, where installed as part of listed equipment, if suitable overcurrent protection and disconnecting means are provided.

Changed from NEC 2008

230.82(9): The NEC added a new condition for connection on the line side of the service disconnecting means to supply listed communications equipment under the exclusive control of an electric utility.

NEC Language

(9) Connections used only to supply listed communications equipment under the exclusive control of the serving electric utility, if suitable overcurrent protection and disconnecting means are provided. For installations of equipment by the serving electric utility, a disconnecting means is not required if the supply is installed as part of a meter socket, such that access can only be gained with the meter removed.

VII. Service Equipment — Overcurrent Protection

230.92 Locked Service Overcurrent Devices

Changed from NEC 2008

230.92: This was revised to include feeder overcurrent devices.

Where the service overcurrent devices are locked or sealed or are not readily accessible to the occupant, branch-circuit or feeder overcurrent devices shall be installed on the load side, shall be mounted in a readily accessible location, and shall be of lower ampere rating than the service overcurrent device.

VIII. Services Exceeding 600 Volts, Nominal

230.205 Disconnecting Means

Changed from NEC 2008

230.205(A) **Location**: This was revised to require that disconnecting means be operable by mechanical linkage from a readily accessible point or be electronically operated.

NEC Language

(A) **Location**. The service disconnecting means shall be located in accordance with 230.70.

For either overhead or underground primary distribution systems on private property, the service disconnect shall be permitted to be located in a location that is not readily accessible, if the disconnecting means can be operated by mechanical linkage from a readily accessible point, or electronically in accordance with 230.205(C), where applicable.

230.208 Protection Requirements

NEC Language

A short-circuit protective device shall be provided on the load side of, or as an integral part of, the service disconnect, and shall protect all ungrounded conductors that it supplies. The protective device shall be capable of detecting and interrupting all values of current, in excess of its trip setting or melting point, that can occur at its location. A fuse rated in continuous amperes not to exceed three times the ampacity of the conductor, or a circuit breaker with a trip setting of not more than six times the ampacity of the conductors, shall be considered as providing the required short-circuit protection.

Changed from NEC 2008

230.208 Informational Note: This was revised to correlate with the renumbering of ampacity tables in Article 310.

NEC Language

Informational Note: See Table 310.60(C)(67) through Table 310.60(C)(86) for ampacities of conductors rated 2001 volts and above.

Overcurrent devices shall conform to 230.208(A) and (B).

(A) **Equipment Type.** Equipment used to protect service-entrance conductors shall meet the requirements of Article 490, Part II.

(B) **Enclosed Overcurrent Devices.** The restriction to 80 percent of the rating for an enclosed overcurrent device for continuous loads shall not apply to overcurrent devices installed in systems operating at over 600 volts.

Article 240 — Overcurrent Protection

Article 240 provides the requirements for overcurrent protection and overcurrent devices. Overcurrent protection for conductors and equipment opens the circuit if the current reaches a value that will cause an excessive or dangerous temperature on the conductors or conductor insulation

I. General

240.4 Protection of Conductors

NEC Language

Conductors, other than flexible cords, flexible cables, and fixture wires, shall be protected against overcurrent in accordance with their ampacities specified in 310.15, unless otherwise permitted or required in 240.4(A) through (G).

Changed from NEC 2008

240.4 Informational Note: The NEC added a new informational note referencing ICEA P-32 -382 for allowable conductor short-circuit currents.

NEC Language

Informational Note: See ICEA P-32-382-2007 for information on allowable short-circuit currents for insulated copper and aluminum conductors.

(A) **Power Loss Hazard.** Conductor overload protection shall not be required where the interruption of the circuit would create a hazard, such as in a material-handling magnet circuit or fire pump circuit. Short-circuit protection shall be provided.

Informational Note: See NFPA 20-2010, Standard for the Installation of Stationary Pumps for Fire Protection.

(B) Overcurrent Devices Rated 800 Amperes or Less. The next higher standard overcurrent device rating (above the ampacity of the conductors being protected) shall be permitted to be used, provided all of the following conditions are met:

Changed from NEC 2008

240.4(B)(1): This was revised to specify that "rounding up" to the next standard size overcurrent protective device does not apply where the branch circuit supplies more than one receptacle.

NEC Language

(1) The conductors being protected are not part of a branch circuit supplying more than one receptacle for cord-and-plug-connected portable loads.

240.15 Ungrounded Conductors (Overcurrent Protection)

Changed from NEC 2008

The NEC made revisions to the requirements for circuit breakers used as overcurrent devices and for the use of identified handle ties.

NEC Language

(B) Circuit Breaker as Overcurrent Device. Circuit breakers shall open all ungrounded conductors of the circuit both manually and automatically unless otherwise permitted in 240.15(B)(1), (B)(2), (B)(3), and (B)(4).

Changed from NEC 2008

240.15(B)(1) **Multiwire Branch Circuit:** This was revised to correlate with the 210.4(B) requirement covering disconnecting means for multiwire branch circuits.

NEC Language

(1) **Multiwire Branch Circuit.** Individual single-pole circuit breakers, with identified handle ties, shall be permitted as the protection for each ungrounded conductor of multiwire branch circuits that serve only single-phase line-to-neutral loads.

Changed from NEC 2008

240.15(B)(2) **Grounded Single-Phase Alternating-Current Circuits:** This was revised for correlation with ac voltages specified in UL 489.

NEC Language

(2) **Grounded Single-Phase Alternating-Current Circuits.** In grounded systems, individual single-pole circuit breakers rated 120/240 volts ac, with identified handle ties, shall be permitted as the protection for each ungrounded conductor for line-to-line connected loads for single-phase circuits.

Changed from NEC 2008

240.15(B)(3) **3-Phase and 2-Phase Systems:** This was revised for correlation with ac voltages specified in UL 489.

NEC Language

(3) **3-Phase and 2-Phase Systems.** For line-to-line loads in 4-wire, 3-phase systems or 5-wire, 2-phase systems, individual single-pole circuit breakers rated 120/240 volts ac with identified handle ties shall be permitted as the protection for each ungrounded conductor, if the systems have a grounded neutral point and the voltage to ground does not exceed 120 volts.

Changed from NEC 2008

240.15(B)(4) **3-Wire Direct-Current Circuits:** Added new requirement to cover use of circuit breakers in dc circuits. Correlates with the requirements specified in UL 489.

NEC Language

(4) **3-Wire Direct-Current Circuits.** Individual single-pole circuit breakers rated 125/250 volts dc with identified handle ties shall be permitted as the protection for each ungrounded conductor for line-to-line connected loads for 3-wire, direct-current circuits supplied from a system with a grounded neutral where the voltage to ground does not exceed 125 volts.

Changed from NEC 2008

240.15(C): Deleted requirement to correlate with the removal of Article 780 in the 2008 edition of the NEC.

NEC Language

(A) **Overcurrent Device Required.** A fuse or an overcurrent trip unit of a circuit breaker shall be connected in series with each ungrounded conductor. A combination of a current transformer and overcurrent relay shall be considered equivalent to an overcurrent trip unit.

Informational Note: For motor circuits, see Parts III, IV, V, and XI of Article 430.

(B) **Circuit Breaker as Overcurrent Device.** Circuit breakers shall open all ungrounded conductors of the circuit both manually and automatically unless otherwise permitted in 240.15(B)(1), (B)(2), (B)(3), and (B)(4).

II. Location

240.21 Location in Circuit

NEC Language

Overcurrent protection shall be provided in each ungrounded circuit conductor and shall be located at the point where the conductors receive their supply except as specified in 240.21(A) through (H). Conductors supplied under the provisions of 240.21(A) through (H) shall not supply another conductor except through an overcurrent protective device meeting the requirements of 240.4.

(A) **Branch-Circuit Conductors.** Branch-circuit tap conductors meeting the requirements specified in 210.19 shall be permitted to have overcurrent protection as specified in 210.20.

(B) **Feeder Taps.** Conductors shall be permitted to be tapped, without overcurrent protection at the tap, to a feeder as specified in 240.21(B)(1) through (B)(5). The provisions of 240.4(B) shall not be permitted for tap conductors.

(1) **Taps Not over 3 m (10 ft) Long.** If the length of the tap conductors does not exceed 3 m (10 ft) and the tap conductors comply with all of the following:

- (1) The ampacity of the tap conductors is
 - a. Not less than the combined calculated loads on the circuits supplied by the tap conductors, and
 - b. Not less than the rating of the device supplied by the tap conductors or not less than the rating of the overcurrent protective device at the termination of the tap conductors.

(2) The tap conductors do not extend beyond the switchboard, panelboard, disconnecting means, or control devices they supply.

(3) Except at the point of connection to the feeder, the tap conductors are enclosed in a raceway, which shall extend from the tap to the enclosure of an enclosed switchboard, panelboard, or control devices, or to the back of an open switchboard.

Changed from NEC 2008

240.21(B)(1)(4): This is an editorial revision for consistency with similar requirements in 240.21.

NEC Language

(4) For field installations, if the tap conductors leave the enclosure or vault in which the tap is made, the ampacity of the tap conductors is not less than one-tenth of the rating of the overcurrent device protecting the feeder conductors.

Informational Note: For overcurrent protection requirements for panelboards, see 408.36.

Changed from NEC 2008

240.21(H) **Battery Conductors:** This is an editorial revision to use the defined term hazardous (classified) location.

NEC Language

(H) **Battery Conductors.** Overcurrent protection shall be permitted to be installed as close as practicable to the storage battery terminals in an unclassified location. Installation of the overcurrent protection within a hazardous (classified) location shall also be permitted.

240.24 Location in or on Premises

NEC Language

(A) **Accessibility.** Overcurrent devices shall be readily accessible and shall be installed so that the center of the grip of the operating handle of the switch or circuit breaker, when in its highest position, is not more than 2.0 m (6 ft 7 in.) above the floor or working platform, unless one of the following applies:

- (1) For busways, as provided in 368.17(C).
- (2) For supplementary overcurrent protection, as described in 240.10.
- (3) For overcurrent devices, as described in 225.40 and 230.92.
- (4) For overcurrent devices adjacent to utilization equipment that they supply, access shall be permitted to be by portable means.

(B) **Occupancy.** Each occupant shall have ready access to all overcurrent devices protecting the conductors supplying that occupancy, unless otherwise permitted in 240.24(B)(1) and (B)(2).

(1) **Service and Feeder Overcurrent Devices.** Where electric service and electrical maintenance are provided by the building management and where these are under continuous building management supervision, the service overcurrent devices and feeder overcurrent devices supplying more than one occupancy shall be permitted to be accessible only to authorized management personnel in the following:

- (1) Multiple-occupancy buildings
- (2) Guest rooms or guest suites

(2) **Branch-Circuit Overcurrent Devices.** Where electric service and electrical maintenance are provided by the building management and where these are under continuous building management supervision, the branch-circuit overcurrent devices supplying any guest rooms or guest suites without permanent provisions for cooking shall be permitted to be accessible only to authorized management personnel.

(C) **Not Exposed to Physical Damage.** Overcurrent devices shall be located where they will not be exposed to physical damage.

Informational Note: See 110.11, Deteriorating Agents.

(D) **Not in Vicinity of Easily Ignitable Material.** Overcurrent devices shall not be located in the vicinity of easily ignitable material, such as in clothes closets.

Changed from NEC 2008

240.24(E) **Not Located in Bathrooms:** This was revised to include dormitories and to apply to guest rooms and guest suites in any occupancy.

The list of occupancy types where overcurrent devices are not permitted in bathrooms has expanded to dormitories.

NEC Language

(E) **Not Located in Bathrooms.** In dwelling units, dormitories, and guest rooms or guest suites, overcurrent devices, other than supplementary overcurrent protection, shall not be located in bathrooms.

(F) **Not Located over Steps.** Overcurrent devices shall not be located over steps of a stairway.

VII. Circuit Breakers

240.87 Noninstantaneous Trip

Changed from NEC 2008

240.87: The NEC added a new requirement to document use of circuit breakers without an instantaneous trip and, where used, to provide means to reduce incident energy.

New provisions were added to provide one of the three arc-flash energy reducing methods (or approved equivalent means) when power circuit breakers without instantaneous trip are used.

Highlight

Under the new Article 240, it is possible to install a circuit breaker without an instantaneous trip. These types of breakers are primarily used for selective trip coordination purposes, and must be installed only under specific conditions. One of three equivalent means must be provided:

- (1) Zone-selective interlocking
- (2) Differential relaying or
- (3) Energy-reducing maintenance switching with a local status indicator.

When installed for coordination purposes, noninstantaneous trip breakers delay the opening of an upstream circuit breaker while the downstream overcurrent device clears a short circuit. This prevents the upstream breakers from tripping due to the actions of a smaller downstream unit, and it allows more time for the downstream breaker to clear its fault. The problem with this type of system is the added risk to the personnel while working on the system. Any fault would result in an extended trip time and would increase the hazards that he is exposed to within the arc-flash boundaries, whereas an instantaneous trip device would instantly stop the current.

NEC Language

Where a circuit breaker is used without an instantaneous trip, documentation shall be available to those authorized to design, install, operate, or inspect the installation as to the location of the circuit breaker(s).

Where a circuit breaker is utilized without an instantaneous trip, one of the following or approved equivalent means shall be provided:

- (1) Zone-selective interlocking
- (2) Differential relaying
- (3) Energy-reducing maintenance switching with local status indicator

Changed from NEC 2008

240.87 Informational Note: The NEC added a new informational note on the purpose and operation of an energy-reducing maintenance switch.

NEC Language

Informational Note: An energy-reducing maintenance switch allows a worker to set a circuit breaker trip unit to "no intentional delay" to reduce the clearing time while the worker is working within an arc-flash boundary as defined in NFPA 70E-2009, Standard for Electrical Safety in the Workplace, and then to set the trip unit back to a normal setting after the potentially hazardous work is complete.

VIII. Supervised Industrial Installations

240.91 Protection of Conductors

Changed from NEC 2008

The NEC added new provisions for limited "round up" conductor protection with overcurrent devices rated over 800 amperes in supervised industrial installations.

NEC Language

Conductors shall be protected in accordance with 240.91(A) or (B).

(A) General. Conductors shall be protected in accordance with 240.4.

Changed from NEC 2008

240.91(B) Devices Rated Over 800 Amperes: The NEC added a new requirement for supervised industrial installations permitting “rounding up” applications in circuits protected by overcurrent protective devices rated more than 800 amperes.

NEC Language

(B) Devices Rated Over 800 Amperes. Where the overcurrent device is rated over 800 amperes, the ampacity of the conductors it protects shall be equal to or greater than 95 percent of the rating of the overcurrent device specified in 240.6 in accordance with (B)(1) and (2).

- (1) The conductors are protected within recognized time vs. current limits for short-circuit currents
- (2) All equipment in which the conductors terminate is listed and marked for the application.

Highlight

This section has been revised to allow more efficient use of conductors and over-current devices when rated over 800 amperes.

The panels recognize the fact that it is inefficient and unnecessary to require that over-current protection devices be sized at 100% of the protected conductors in supervised industrial applications.

Overcurrent protection in this type of environment is generally sized as a part of a coordination study which makes the sizing less critical. The requirement will now be that where the overcurrent device is rated over 800 amperes, the ampacity of the conductors it protects shall be equal to or greater than 95% of the rating of the overcurrent device defined in 240.6, where the conductor is protected within recognized time vs. current limits for all short circuit currents of up to 1000 seconds duration.

This requirement will only be applicable in supervised industrial installations, in other words, only in areas to be operated under the direction of qualified maintenance and engineering supervision.

Article 250 — Grounding and Bonding

Article 250 covers the grounding requirements for providing a low impedance path to the earth to reduce overvoltage from lightning, and the requirements for low impedance fault current path necessary to facilitate the operation of overcurrent devices in the event of a ground fault.

Specifically, coverage applies to general requirements for grounding and bonding of electrical installations, and the specific requirements in (1) through (6).

- (1) Systems, circuits, and equipment required, permitted, or not permitted to be grounded
- (2) Circuit conductor to be grounded on grounded systems
- (3) Location of grounding connections
- (4) Types and sizes of grounding and bonding conductors and electrodes
- (5) Methods of grounding and bonding
- (6) Conditions under which guards, isolation, or insulation may be substituted for grounding

The following Figure provides information on the organization of Article 250 covering grounding and bonding requirements.

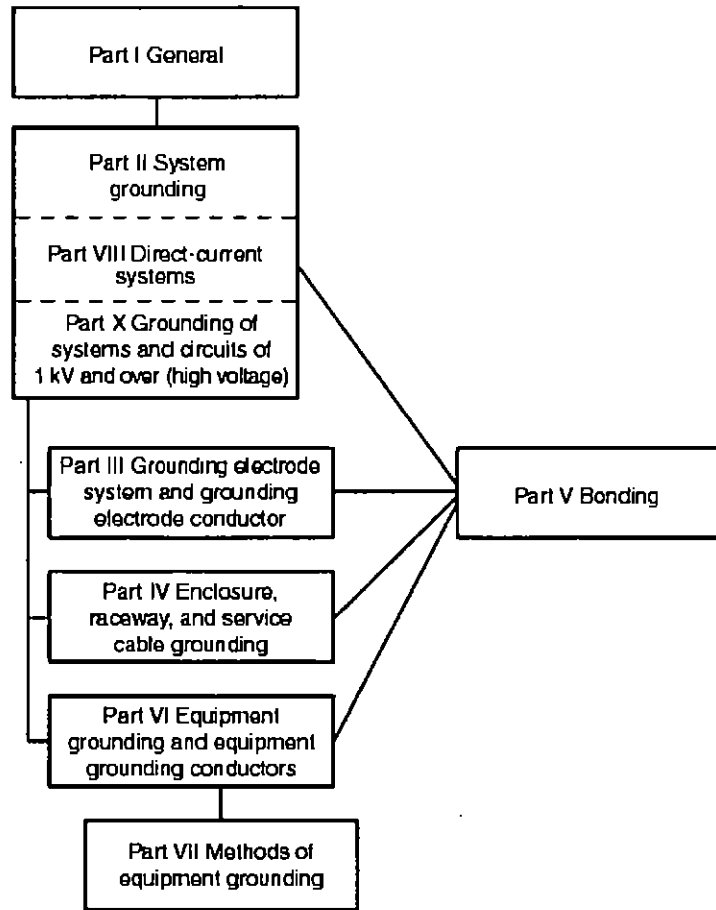

NEC 2011

I. General

250.2 Definitions

Changed from NEC 2008

250.2 Bonding Jumper, Supply Side: The NEC added a new definition for a bonding jumper that is not an equipment bonding jumper.

NEC Language

Bonding Jumper, Supply-Side. A conductor installed on the supply side of a service or within a service equipment enclosure(s), or for a separately derived system, that ensures the required electrical conductivity between metal required to be electrically connected.

250.6 Objectionable Current

NEC Language

Changed from NEC 2008

250.6(C) **Temporary Currents Not Classified as Objectionable Currents:** This was revised by replacing "accidental" with "abnormal."

NEC Language

(C) **Temporary Currents Not Classified as Objectionable Currents.** Temporary currents resulting from **abnormal** conditions, such as ground faults, shall not be classified as objectionable current for the purposes specified in 250.6(A) and (B).

250.8 Connection of Grounding and Bonding Equipment

Changed from NEC 2008

250.8: This was revised to include specific reference to grounding electrode conductors and to delete reference to grounding conductor.

NEC Language

(A) **Permitted Methods.** Equipment grounding conductors, grounding electrode conductors, and bonding jumpers shall be connected by one of the following means:

- (1) Listed pressure connectors
- (2) Terminal bars
- (3) Pressure connectors listed as grounding and bonding equipment
- (4) Exothermic welding process
- (5) Machine screw-type fasteners that engage not less than two threads or are secured with a nut
- (6) Thread-forming machine screws that engage not less than two threads in the enclosure
- (7) Connections that are part of a listed assembly
- (8) Other listed means

(B) **Methods Not Permitted.** Connection devices or fittings that depend solely on solder shall not be used.

II. System Grounding

250.21 Alternating-Current Systems of 50 Volts to Less Than 1000 Volts Not Required to Be Grounded

NEC Language

(A) **General.** The following ac systems of 50 volts to less than 1000 volts shall be permitted to be grounded but shall not be required to be grounded:

- (1) Electrical systems used exclusively to supply industrial electric furnaces for melting, refining, tempering, and the like

- (2) Separately derived systems used exclusively for rectifiers that supply only adjustable-speed industrial drives
- (3) Separately derived systems supplied by transformers that have a primary voltage rating less than 1000 volts, provided that all the following conditions are met:
 - a. The system is used exclusively for control circuits.
 - b. The conditions of maintenance and supervision ensure that only qualified persons service the installation.
 - c. Continuity of control power is required.
- (4) **Other systems** that are not required to be grounded in accordance with the requirements of 250.20(B)

Changed from NEC 2008

250.21(B) Ground Detectors: The NEC added a new requirement to specify location of a ground detection sensing equipment.

NEC Language

(B) **Ground Detectors.** Ground detectors shall be installed in accordance with 250.21(B)(1) and (B)(2).

- (1) Ungrounded alternating current systems as permitted in 250.21(A)(1) through (A)(4) operating at not less than 120 volts and not exceeding 1000 volts shall have ground detectors installed on the system.
- (2) The ground detection sensing equipment shall be connected as close as practicable to where the system receives its supply.

Changed from NEC 2008

250.21(C) Marking: The NEC added a new requirement on marking ungrounded systems to at the source or the first system disconnecting means.

NEC Language

(C) **Marking.** Ungrounded systems shall be legibly marked "Ungrounded System" at the source or first disconnecting means of the system. The marking shall be of sufficient durability to withstand the environment involved.

250.24 Grounding Service-Supplied Alternating-Current Systems

NEC Language

(A) **System Grounding Connections.** A premises wiring system supplied by a grounded ac service shall have a grounding electrode conductor connected to the grounded service conductor, at each service, in accordance with 250.24(A)(1) through (A)(5).

- (1) **General.** The grounding electrode conductor connection shall be made at any accessible point from the load end of the service drop or service lateral to and including the terminal or bus to which the grounded service conductor is connected at the service disconnecting means.

Informational Note: See definitions of Service Drop and Service Lateral in Article 100.

- (2) **Outdoor Transformer.** Where the transformer supplying the service is located outside the building, at least one additional grounding connection shall be made from

the grounded service conductor to a grounding electrode, either at the transformer or elsewhere outside the building.

Exception: The additional grounding electrode conductor connection shall not be made on high-impedance grounded neutral systems. The system shall meet the requirements of 250.36.

(3) **Dual-Fed Services.** For services that are dual fed (double ended) in a common enclosure or grouped together in separate enclosures and employing a secondary tie, a single grounding electrode conductor connection to the tie point of the grounded conductor(s) from each power source shall be permitted.

(4) **Main Bonding Jumper as Wire or Busbar.** Where the main bonding jumper specified in 250.28 is a wire or busbar and is installed from the grounded conductor terminal bar or bus to the equipment grounding terminal bar or bus in the service equipment, the grounding electrode conductor shall be permitted to be connected to the equipment grounding terminal, bar, or bus to which the main bonding jumper is connected.

(5) **Load-Side Grounding Connections.** A grounded conductor shall not be connected to normally non-current-carrying metal parts of equipment, to equipment grounding conductor(s), or be reconnected to ground on the load side of the service disconnecting means except as otherwise permitted in this article.

Informational Note: See 250.30 for separately derived systems, 250.32 for connections at separate buildings or structures, and 250.142 for use of the grounded circuit conductor for grounding equipment.

(B) **Main Bonding Jumper.** For a grounded system, an unspliced main bonding jumper shall be used to connect the equipment grounding conductor(s) and the service-disconnect enclosure to the grounded conductor within the enclosure for each service disconnect in accordance with 250.28.

Exception No. 1: Where more than one service disconnecting means is located in an assembly listed for use as service equipment, an unspliced main bonding jumper shall bond the grounded conductor(s) to the assembly enclosure.

Exception No. 2: Impedance grounded neutral systems shall be permitted to be connected as provided in 250.36 and 250.186.

Changed from NEC 2008

250.24(C) Grounded Conductor Brought to Service Equipment: This is an editorial revision for clarity on routing of grounded conductor.

NEC Language

(C) **Grounded Conductor Brought to Service Equipment.** Where an ac system operating at less than 1000 volts is grounded at any point, the grounded conductor(s) shall be routed with the ungrounded conductors to each service disconnecting means and shall be connected to each disconnecting means grounded conductor(s) terminal or bus. A main bonding jumper shall connect the grounded conductor(s) to each service disconnecting means enclosure. The grounded conductor(s) shall be installed in accordance with 250.24(C)(1) through (C)(4).

Exception: Where two or more service disconnecting means are located in a single assembly listed for use as service equipment, it shall be permitted to connect the grounded conductor(s) to the assembly common grounded conductor(s) terminal or bus. The assembly shall include a main bonding jumper for connecting the grounded conductor(s) to the assembly enclosure.

(1) **Sizing for a Single Raceway.** The grounded conductor shall not be smaller than the required grounding electrode conductor specified in Table 250.66 but shall not be required to be larger than the largest ungrounded service-entrance conductor(s). In addition, for sets of ungrounded service-entrance conductors larger than 1100 kcmil copper or 1750 kcmil aluminum, the grounded conductor shall not be smaller than 12½ percent of the circular mil area of the largest set of service-entrance ungrounded conductor(s).

(2) **Parallel Conductors in Two or More Raceways.** If the ungrounded service-entrance conductors are installed in parallel in two or more raceways, the grounded conductor shall also be installed in parallel. The size of the grounded conductor in each raceway shall be based on the total circular mil area of the parallel ungrounded conductors in the raceway, as indicated in 250.24(C)(1), but not smaller than 1/0 AWG.

Informational Note: See 310.10(H) for grounded conductors connected in parallel.

(3) **Delta-Connected Service.** The grounded conductor of a 3-phase, 3-wire delta service shall have an ampacity not less than that of the ungrounded conductors.

(4) **High Impedance.** The grounded conductor on a high-impedance grounded neutral system shall be grounded in accordance with 250.36.

250.30 Grounding Separately Derived Alternating-Current Systems Changed from NEC 2008

The NEC reorganized and added to the requirements for grounding of separately derived systems have been employed for usability and clarity.

In addition to complying with 250.30(A) for grounded systems, or as provided in 250.30(B) for ungrounded systems, separately derived systems shall comply with 250.20, 250.21, 250.22, and 250.26.

Highlight

This section details the requirements for grounding separately derived AC current systems. It has been extensively revised and reorganized for the 2011 NEC cycle.

The majority of the changes help to better organize and clarify the section, there are new requirements as well. The revised sections will apply separately to grounded systems, 250.30(A) and ungrounded systems, 250.30(B).

An unspliced system bonding jumper is required and sized per section 250.28(A). Added new in this section are the following requirements depending on the location:

- a) Installed at the Source. The system bonding jumper shall connect the grounded conductor to the supply-side bonding jumper and the normally non-current-carrying metal enclosure.
- b) Installed at the First Disconnecting Means. The system bonding jumper shall connect the grounded conductor to the supply-side bonding jumper, the disconnecting means enclosure, and the equipment grounding conductor(s).

The system bonding jumper shall remain within the enclosure where it originates.

Also a notable change, the connection of a grounding electrode conductor tap to a common grounding electrode conductor must be made with a connector listed as grounding and bonding equipment. Outdoor sources require a grounding electrode connection at the source location outside the building.

Separately derived systems that are located outside of a building or structure they serve must have a grounding electrode connection to one or more grounding electrodes in compliance with section 250.30.

NEC Language

Informational Note No. 1: An alternate ac power source, such as an on-site generator, is not a separately derived system if the grounded conductor is solidly interconnected to a service-supplied system grounded conductor. An example of such a situation is where alternate source transfer equipment does not include a switching action in the grounded conductor and allows it to remain solidly connected to the service-supplied grounded conductor when the alternate source is operational and supplying the load served.

Informational Note No. 2: See 445.13 for the minimum size of conductors that carry fault current.

Changed from NEC 2008

250.30(A) Grounded Systems: This was revised to prohibit connection of a grounded conductor to ground on the load side of system bonding jumper.

NEC Language

(A) Grounded Systems. A separately derived ac system that is grounded shall comply with 250.30(A)(1) through (A)(8). Except as otherwise permitted in this article, a grounded conductor shall not be connected to normally non-current-carrying metal parts of equipment, be connected to equipment grounding conductors, or be reconnected to ground on the load side of the system bonding jumper.

Informational Note: See 250.32 for connections at separate buildings or structures, and 250.142 for use of the grounded circuit conductor for grounding equipment.

Exception: Impedance grounded neutral system grounding connections shall be made as specified in 250.36 or 250.186, as applicable.

Changed from NEC 2008

250.30(A)(1) System Bonding Jumper: This was revised to prohibit system bonding jumpers from being installed between source and enclosure containing first system disconnecting means/overcurrent protective device.

NEC Language

(1) System Bonding Jumper. An unspliced system bonding jumper shall comply with 250.28(A) through (D). This connection shall be made at any single point on the separately derived system from the source to the first system disconnecting means or overcurrent device, or it shall be made at the source of a separately derived system that has no disconnecting means or overcurrent devices, in accordance with 250.30(A)(1)(a) or (b). The system bonding jumper shall remain within the enclosure where it originates. If the source is located outside the building or structure supplied, a system bonding jumper shall be installed at the grounding electrode connection in compliance with 250.30(C).

Changed from NEC 2008

250.30(A)(1) Exception 1: This was revised to apply only to systems installed per 450.6.

NEC Language

Exception No. 1: For systems installed in accordance with 450.6, a single system bonding jumper connection to the tie point of the grounded circuit conductors from each power source shall be permitted.

Exception No. 2: A system bonding jumper at both the source and the first disconnecting means shall be permitted if doing so does not establish a parallel path for the grounded

conductor. If a grounded conductor is used in this manner, it shall not be smaller than the size specified for the system bonding jumper but shall not be required to be larger than the ungrounded conductor(s). For the purposes of this exception, connection through the earth shall not be considered as providing a parallel path.

Changed from NEC 2008

250.30(A)(1) Exception 3: This was revised to clarify that a system bonding jumper cannot be smaller than derived ungrounded conductors.

NEC Language

Exception No. 3: The size of the system bonding jumper for a system that supplies a Class 1, Class 2, or Class 3 circuit, and is derived from a transformer rated not more than 1000 volt-amperes, shall not be smaller than the derived ungrounded conductors and shall not be smaller than 14 AWG copper or 12 AWG aluminum.

Changed from NEC 2008

250.30(A)(1)(a) & (b): The NEC added a new requirements covering connection of a system bonding jumper at the source or at the first system disconnecting means.

NEC Language

(a) Installed at the Source. The system bonding jumper shall connect the grounded conductor to the supply-side bonding jumper and the normally non-current-carrying metal enclosure.

(b) Installed at the First Disconnecting Means. The system bonding jumper shall connect the grounded conductor to the supply-side bonding jumper, the disconnecting means enclosure, and the equipment grounding conductor(s).

Changed from NEC 2008

250.30(A)(2) Supply-Side Bonding Jumper: This was revised to require installation of supply-side bonding jumper between the source enclosure and an enclosure containing the first system disconnecting means or overcurrent protective device, and to clarify that the supply-side bonding jumper can be nonflexible metal raceway, a wire, or bus.

NEC Language

(2) **Supply-Side Bonding Jumper.** If the source of a separately derived system and the first disconnecting means are located in separate enclosures, a supply-side bonding jumper shall be installed with the circuit conductors from the source enclosure to the first disconnecting means. A supply-side bonding jumper shall not be required to be larger than the derived ungrounded conductors. The supply-side bonding jumper shall be permitted to be of nonflexible metal raceway type or of the wire or bus type as follows:

(a) A supply-side bonding jumper of the wire type shall comply with 250.102(C), based on the size of the derived ungrounded conductors.

(b) A supply-side bonding jumper of the bus type shall have a cross-sectional area not smaller than a supply-side bonding jumper of the wire type as determined in 250.102(C).

Changed from NEC 2008

250.30(A)(3) Grounded Conductor: This revised and relocated requirements for sizing the grounded conductor for single and parallel conductor installations and for delta-connected and impedance grounded systems.

NEC Language

(3) **Grounded Conductor.** If a grounded conductor is installed and the system bonding jumper connection is not located at the source, 250.30(A)(3)(a) through (A)(3)(d) shall apply.

(a) **Sizing for a Single Raceway.** The grounded conductor shall not be smaller than the required grounding electrode conductor specified in Table 250.66 but shall not be required to be larger than the largest derived ungrounded conductor(s). In addition, for sets of derived ungrounded conductors larger than 1100 kcmil copper or 1750 kcmil aluminum, the grounded conductor shall not be smaller than 12½ percent of the circular mil area of the largest set of derived ungrounded conductors.

(b) **Parallel Conductors in Two or More Raceways.** If the ungrounded conductors are installed in parallel in two or more raceways, the grounded conductor shall also be installed in parallel. The size of the grounded conductor in each raceway shall be based on the total circular mil area of the parallel derived ungrounded conductors in the raceway as indicated in 250.30(A)(3)(a), but not smaller than 1/0 AWG.

Informational Note: See 310.10(H) for grounded conductors connected in parallel.

(c) **Delta-Connected System.** The grounded conductor of a 3-phase, 3-wire delta system shall have an ampacity not less than that of the ungrounded conductors.

(d) **Impedance Grounded System.** The grounded conductor of an impedance grounded neutral system shall be installed in accordance with 250.36 or 250.186, as applicable.

Changed from NEC 2008

250.30(A)(4) Grounding Electrode: This relocated requirements covering the grounding electrode for separately derived systems.

NEC Language

(4) **Grounding Electrode.** The grounding electrode shall be as near as practicable to, and preferably in the same area as, the grounding electrode conductor connection to the system. The grounding electrode shall be the nearest of one of the following:

- (1) Metal water pipe grounding electrode as specified in 250.52(A)(1)
- (2) Structural metal grounding electrode as specified in 250.52(A)(2)

Exception No. 1: Any of the other electrodes identified in 250.52(A) shall be used if the electrodes specified by 250.30(A)(4) are not available.

Exception No. 2 to (1) and (2): If a separately derived system originates in listed equipment suitable for use as service equipment, the grounding electrode used for the service or feeder equipment shall be permitted as the grounding electrode for the separately derived system.

Informational Note No. 1: See 250.104(D) for bonding requirements for interior metal water piping in the area served by separately derived systems.

Informational Note No. 2: See 250.50 and 250.58 for requirements for bonding all electrodes together if located at the same building or structure.

Changed from NEC 2008

250.30(A)(6)(a)(2): The NEC added a new requirement covering the use of metal building frame as a grounding electrode conductor.

NEC Language

(2) The metal frame of the building or structure that complies with 250.52(A)(2) or is connected to the grounding electrode system by a conductor that shall not be smaller than 3/0 AWG copper or 250 kcmil aluminum

Changed from NEC 2008

250.30(B)(3) **Bonding Path and Conductor:** The NEC added a new requirement covering installation of a supply-side bonding jumper between the source enclosure and an enclosure containing the first system disconnecting means or overcurrent protective device.

NEC Language

(3) **Bonding Path and Conductor.** A supply-side bonding jumper shall be installed from the source of a separately derived system to the first disconnecting means in compliance with 250.30(A)(2).

Changed from NEC 2008

250.30(C) **Outdoor Source:** The NEC added a new requirement for grounding of separately derived systems located outside the building or structure supplied.

NEC Language

(C) **Outdoor Source.** If the source of the separately derived system is located outside the building or structure supplied, a grounding electrode connection shall be made at the source location to one or more grounding electrodes in compliance with 250.50. In addition, the installation shall comply with 250.30(A) for grounded systems or with 250.30(B) for ungrounded systems.

Exception: The grounding electrode conductor connection for impedance grounded neutral systems shall comply with 250.36 or 250.186, as applicable.

250.32 Buildings or Structures Supplied by a Feeder(s) or Branch Circuit(s)**NEC Language**

Requirements for grounding at separate building have been revised for usability and clarity.

(A) **Grounding Electrode.** Building(s) or structure(s) supplied by feeder(s) or branch circuit(s) shall have a grounding electrode or grounding electrode system installed in accordance with Part III of Article 250. The grounding electrode conductor(s) shall be connected in accordance with 250.32(B) or (C). Where there is no existing grounding electrode, the grounding electrode(s) required in 250.50 shall be installed.

Where a building or structure is supplied by a feeder or branch circuit, 250.32(A) requires that a grounding electrode system be established at each building or structure supplied, unless one already exists. The equipment grounding bus must be bonded to the grounding electrode system as is shown for Buildings 2 and 3 in Exhibit 250.17. Building 1 is supplied by a service and is grounded in accordance with 250.24(A) through (D), and the disconnecting means enclosure, building steel, and interior metal

water piping are also required to be bonded to the grounding electrode system. All exposed non-current-carrying metal parts of electrical equipment are required to be grounded through equipment grounding conductor connections to the equipment grounding bus at the building disconnecting means. The grounded conductor of the feeder supplying Building 2 is permitted to be "re-grounded" per 250.32(B)(1), Exception. An equipment grounding conductor is run with the feeder to Building 3 as specified in the general requirement of 250.32(B).

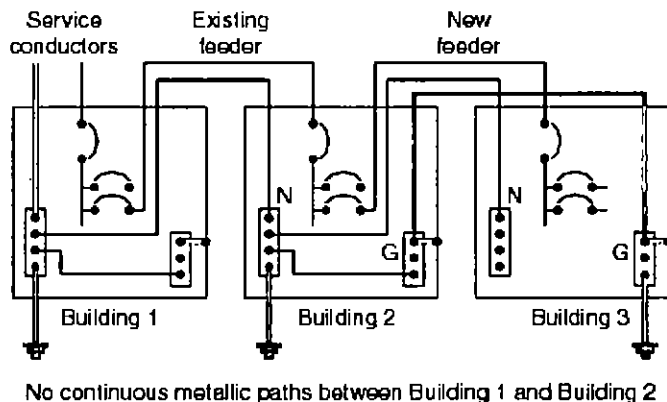

NEC 2011

Exhibit 250.17 Example of grounding electrode systems required at feeder-supplied Building 2 and Building 3, in accordance with 250.32(A) and (B).

Exception: A grounding electrode shall not be required where only a single branch circuit, including a multiwire branch circuit, supplies the building or structure and the branch circuit includes an equipment grounding conductor for grounding the normally non-current-carrying metal parts of equipment.

The exception to 250.32(A) exempts a building or structure supplied by a single branch circuit (2-wire or multiwire) from the grounding electrode requirement provided an equipment grounding conductor is installed with or encloses the branch circuit. Detached garages, sheds, and similar structures supplied by a single branch circuit are examples of where this exception can be applied. See Exhibit 250.18 for an example of this provision.

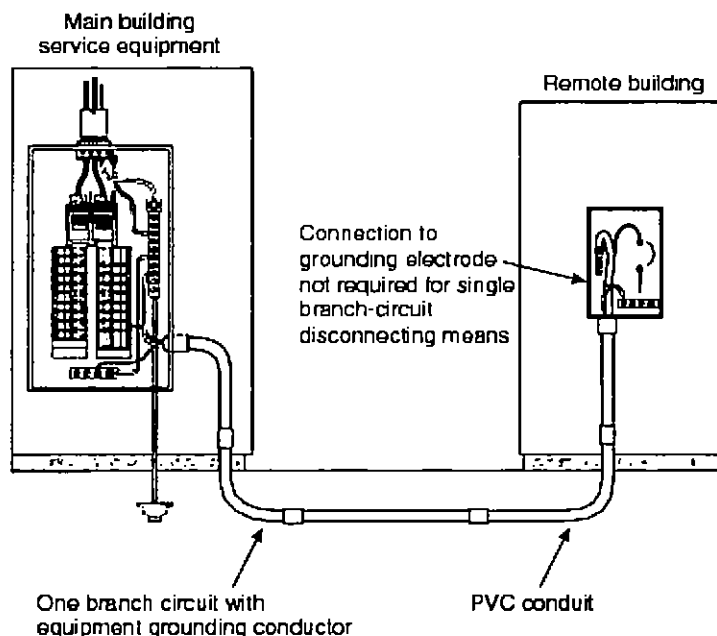

NEC 2011

Exhibit 250.18 An installation where a connection from the single branch-circuit disconnecting means enclosure to a grounding electrode system is not required at the remote building because an equipment grounding conductor is installed with the circuit conductors.

(B) Grounded Systems.

Changed from NEC 2008

250.32(B)(1) Exception: This was revised to clarify the conditions under which a grounded conductor is permitted to serve as a ground-fault return path.

NEC Language

(1) Supplied by a Feeder or Branch Circuit. An equipment grounding conductor, as described in 250.118, shall be run with the supply conductors and be connected to the building or structure disconnecting means and to the grounding electrode(s). The equipment grounding conductor shall be used for grounding or bonding of equipment, structures, or frames required to be grounded or bonded. The equipment grounding conductor shall be sized in accordance with 250.122. Any installed grounded conductor shall not be connected to the equipment grounding conductor or to the grounding electrode(s).

Exception: For installations made in compliance with previous editions of this Code that permitted such connection, the grounded conductor run with the supply to the building or structure shall be permitted to serve as the ground-fault return path if all of the following requirements continue to be met:

Highlight

Section 250.32(B) requires the installation of an equipment grounding conductor with all feeders and branch circuits that supply a building or structure.

Using the grounded conductor to ground equipment, in lieu of installing a separate equipment grounding conductor, creates parallel paths for normal neutral current along metal raceways, metal piping, metal cable sheaths or shields, and other metal structures such as ductwork. Installing an equipment grounding conductor with the supply circuit conductors helps ensure that normal circuit current is not imposed on continuous metal paths other than the insulated grounded or neutral conductor.

At a building or structure supplied by a feeder or branch circuit, the equipment grounding conductor is connected to the grounding electrode system [unless the installation complies with 250.32(A), Exception] in the equipment supplied by the feeder or branch circuit. Where installed, the grounded or neutral conductor is electrically isolated from the equipment grounding conductor and any grounding electrodes at the building or structure supplied by the feeder or branch circuit as illustrated in Exhibit 250.19 below.

Because "re-grounding" the neutral or grounded conductor was permitted in previous editions of the Code, the Exception to 250.32(B) permits limited applications of using the grounded conductor for grounding and bonding of equipment and systems but only for circuits that were installed in compliance with the Code prior to the 2008 edition and where the three conditions specified in the current exception are met.

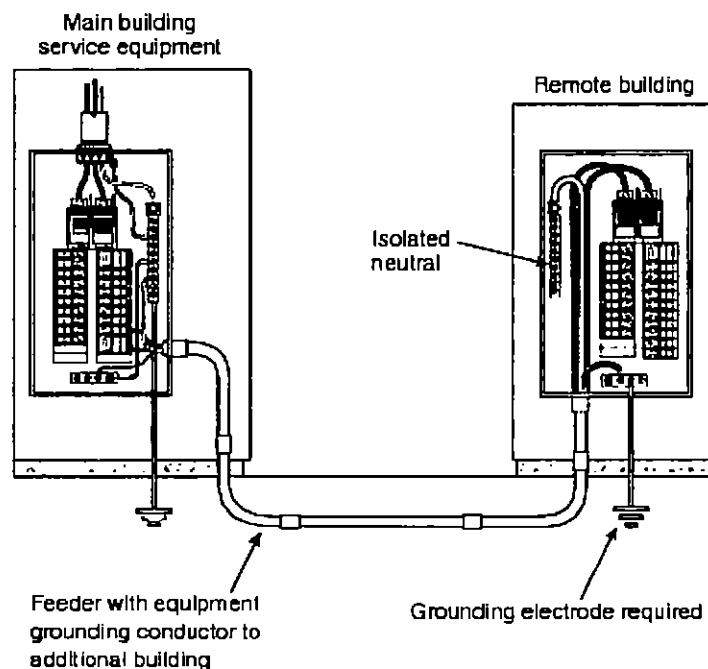

NEC 2011

Exhibit 250.19 An installation performed in accordance with 250.32(B)(1) in which a connection between the grounded conductor (neutral) and equipment grounding terminal bar is not permitted. A connection from the equipment grounding terminal bus to the grounding electrode is required.

- (1) An equipment grounding conductor is not run with the supply to the building or structure.
- (2) There are no continuous metallic paths bonded to the grounding system in each building or structure involved.
- (3) Ground-fault protection of equipment has not been installed on the supply side of the feeder(s).

If the grounded conductor is used for grounding in accordance with the provision of this exception, the size of the grounded conductor shall not be smaller than the larger of either of the following:

- (1) That required by 220.61
- (2) That required by 250.122

Changed from NEC 2008

250.32(B)(2) Supplied by Separately Derived System: The NEC added a new requirements covering buildings or structures supplied by separately derived systems.

NEC Language

(2) Supplied by Separately Derived System.

- (a) **With Overcurrent Protection.** If overcurrent protection is provided where the conductors originate, the installation shall comply with 250.32(B)(1).
- (b) **Without Overcurrent Protection.** If overcurrent protection is not provided where the conductors originate, the installation shall comply with 250.30(A). If installed, the supply-side bonding jumper shall be connected to the building or structure disconnecting means and to the grounding electrode(s).

Changed from NEC 2008

250.32(C) Ungrounded Systems: The NEC added a new requirement covering ungrounded separately derived systems.

NEC Language

(C) Ungrounded Systems.

- (1) **Supplied by a Feeder or Branch Circuit.** An equipment grounding conductor, as described in 250.118, shall be installed with the supply conductors and be connected to the building or structure disconnecting means and to the grounding electrode(s). The grounding electrode(s) shall also be connected to the building or structure disconnecting means.
- (2) **Supplied by a Separately Derived System.**
 - (a) **With Overcurrent Protection.** If overcurrent protection is provided where the conductors originate, the installation shall comply with (C)(1).
 - (b) **Without Overcurrent Protection.** If overcurrent protection is not provided where the conductors originate, the installation shall comply with 250.30(B). If installed, the supply-side bonding jumper shall be connected to the building or structure disconnecting means and to the grounding electrode(s).

250.35 Permanently Installed Generators

NEC Language

A conductor that provides an effective ground-fault current path shall be installed with the supply conductors from a permanently installed generator(s) to the first disconnecting mean(s) in accordance with (A) or (B).

- (A) **Separately Derived System.** If the generator is installed as a separately derived system, the requirements in 250.30 shall apply.

Changed from NEC 2008

250.35(B) Ungrounded Systems: The NEC revised requirements for supply-side bonding jumper if a generator is not a separately derived system and overcurrent protection is not integral to the generator assembly.

NEC Language

(B) **Nonseparately Derived System.** If the generator is installed as a nonseparately derived system, and overcurrent protection is not integral with the generator assembly, a supply-side bonding jumper shall be installed between the generator equipment grounding terminal and the equipment grounding terminal, bar, or bus of the disconnecting mean(s). It shall be sized in accordance with 250.102(C) based on the size of the conductors supplied by the generator.

III. Grounding Electrode System and Grounding Electrode Conductor**250.52 Grounding Electrodes****Changed from NEC 2008**

The NEC refined for clarity the language describing what constitutes a metal underground water pipe as a grounding electrode.

NEC Language**(A) Electrodes Permitted for Grounding.**

(1) **Metal Underground Water Pipe.** A metal underground water pipe in direct contact with the earth for 3.0 m (10 ft) or more (including any metal well casing bonded to the pipe) and electrically continuous (or made electrically continuous by bonding around insulating joints or insulating pipe) to the points of connection of the grounding electrode conductor and the bonding conductor(s) or jumper(s), if installed.

Changed from NEC 2008

250.52(A)(2) Metal Frame of the Building or Structure: This was revised to clarify the two conditions under which the metal frame of a building or structure itself qualifies as a grounding electrode.

NEC Language

(2) **Metal Frame of the Building or Structure.** The metal frame of the building or structure that is connected to the earth by one or more of the following methods:

- (1) At least one structural metal member that is in direct contact with the earth for 3.0 m (10 ft) or more, with or without concrete encasement.
- (2) Hold-down bolts securing the structural steel column that are connected to a concrete-encased electrode that complies with 250.52(A)(3) and is located in the support footing or foundation. The hold-down bolts shall be connected to the concrete-encased electrode by welding, exothermic welding, the usual steel tie wires, or other approved means.
- (3) **Concrete-Encased Electrode.** A concrete-encased electrode shall consist of at least 6.0 m (20 ft) of either (1) or (2):

(1) One or more bare or zinc galvanized or other electrically conductive coated steel reinforcing bars or rods of not less than 13 mm (½ in.) in diameter, installed in one continuous 6.0 m (20 ft) length, or if in multiple pieces connected together by the usual steel tie wires, exothermic welding, welding, or other effective means to create a 6.0 m (20 ft) or greater length; or

(2) Bare copper conductor not smaller than 4 AWG

Metallic components shall be encased by at least 50 mm (2 in.) of concrete and shall be located horizontally within that portion of a concrete foundation or footing that is in direct contact with the earth or within vertical foundations or structural components or members that are in direct contact with the earth. If multiple concrete-encased electrodes are present at a building or structure, it shall be permissible to bond only one into the grounding electrode system.

Changed from NEC 2008

250.52(A)(3) Informational Note: The NEC added a new informational note covering conditions that do not provide direct earth contact.

NEC Language

Informational Note: Concrete installed with insulation, vapor barriers, films or similar items separating the concrete from the earth is not considered to be in "direct contact" with the earth.

(4) **Ground Ring.** A ground ring encircling the building or structure, in direct contact with the earth, consisting of at least 6.0 m (20 ft) of bare copper conductor not smaller than 2 AWG.

(5) **Rod and Pipe Electrodes.** Rod and pipe electrodes shall not be less than 2.44 m (8 ft) in length and shall consist of the following materials.

(a) Grounding electrodes of pipe or conduit shall not be smaller than metric designator 21 (trade size ¾) and, where of steel, shall have the outer surface galvanized or otherwise metal-coated for corrosion protection.

Changed from NEC 2008

250.52(A)(5)(b): This was revised to clarify that the requirement applies to rod-type electrodes. It also removed the minimum dimension for listed rod-type electrodes.

NEC Language

(b) Rod-type grounding electrodes of stainless steel and copper or zinc coated steel shall be at least 15.87 mm (5/8 in.) in diameter, unless listed.

(6) **Other Listed Electrodes.** Other listed grounding electrodes shall be permitted.

Changed from NEC 2008

250.52(A)(7) Plate Electrodes: The NEC revised requirements covering minimum thickness of coated and uncoated plate electrodes made of iron, steel, or nonferrous metal.

NEC Language

(7) **Plate Electrodes.** Each plate electrode shall expose not less than 0.186 m² (2 ft²) of surface to exterior soil. Electrodes of bare or conductively coated iron or steel plates shall be at least 6.4 mm (¼ in.) in thickness. Solid, uncoated electrodes of nonferrous metal shall be at least 1.5 mm (0.06 in.) in thickness.

250.53 Grounding Electrode System Installation

Changed from NEC 2008

Rod, pipe and plate grounding electrodes are now required to be supplemented by an additional electrode.

NEC Language

Informational Note: See 547.9 and 547.10 for special grounding and bonding requirements for agricultural buildings.

(A) **Rod, Pipe, and Plate Electrodes.** Rod, pipe, and plate electrodes shall meet the requirements of 250.53(A)(1) through (A)(3).

(1) **Below Permanent Moisture Level.** If practicable, rod, pipe, and plate electrodes shall be embedded below permanent moisture level. Rod, pipe, and plate electrodes shall be free from nonconductive coatings such as paint or enamel.

Changed from NEC 2008

250.53(A)(2) **Plate Electrodes:** The NEC added a new requirement covering permitted bonding locations for supplemental electrodes.

NEC Language

(2) **Supplemental Electrode Required.** A single rod, pipe, or plate electrode shall be supplemented by an additional electrode of a type specified in 250.52(A)(2) through (A)(8). The supplemental electrode shall be permitted to be bonded to one of the following:

- (1) Rod, pipe, or plate electrode
- (2) Grounding electrode conductor
- (3) Grounded service-entrance conductor
- (4) Nonflexible grounded service raceway
- (5) Any grounded service enclosure

Changed from NEC 2008

250.53(A)(2) **Exception:** Relocated the condition under which a single rod, pipe, or plate electrode is permitted.

NEC Language

Exception: If a single rod, pipe, or plate grounding electrode has a resistance to earth of 25 ohms or less, the supplemental electrode shall not be required.

Changed from NEC 2008

250.53(A)(3) **Supplemental Electrode:** The NEC added a new requirement to provide spacing requirement specific to supplemental electrodes.

NEC Language

(3) **Supplemental Electrode.** If multiple rod, pipe, or plate electrodes are installed to meet the requirements of this section, they shall not be less than 1.8 m (6 ft) apart.

Informational Note: The paralleling efficiency of rods is increased by spacing them twice the length of the longest rod.

Changed from NEC 2008

250.53(B) **Electrode Spacing:** The NEC revised terminology (strike termination devices) for correlation with NFPA 780.

NEC Language

(B) **Electrode Spacing.** Where more than one of the electrodes of the type specified in 250.52(A)(5) or (A)(7) are used, each electrode of one grounding system (including that used for strike termination devices) shall not be less than 1.83 m (6 ft) from any other electrode of another grounding system. Two or more grounding electrodes that are bonded together shall be considered a single grounding electrode system.

250.60 Use of Strike Termination Devices

Changed from NEC 2008

250.60: The NEC revised terminology (strike termination devices) for correlation with NFPA 780.

NEC Language

Conductors and driven pipes, rods, or plate electrodes used for grounding strike termination devices shall not be used in lieu of the grounding electrodes required by 250.50 for grounding wiring systems and equipment. This provision shall not prohibit the required bonding together of grounding electrodes of different systems.

Informational Note No. 1: See 250.106 for spacing from strike termination devices. See 800.100(D), 810.21(J), and 820.100(D) for bonding of electrodes.

Informational Note No. 2: Bonding together of all separate grounding electrodes will limit potential differences between them and between their associated wiring systems.

250.64 Grounding Electrode Conductor Installation

Changed from NEC 2008

Clarification that grounding electrode conductors are permitted to be secured or routed through or on framing members.

NEC Language

Grounding electrode conductors at the service, at each building or structure where supplied by a feeder(s) or branch circuit(s), or at a separately derived system shall be installed as specified in 250.64(A) through (F).

(A) **Aluminum or Copper-Clad Aluminum Conductors.** Bare aluminum or copper-clad aluminum grounding electrode conductors shall not be used where in direct contact with masonry or the earth or where subject to corrosive conditions. Where used outside, aluminum or copper-clad aluminum grounding electrode conductors shall not be terminated within 450 mm (18 in.) of the earth.

Changed from NEC 2008

250.64(B) **Securing and Protection Against Physical Damage:** The NEC added a new requirement permitting grounding electrode conductors to be installed on or through framing members.

NEC Language

(B) **Securing and Protection Against Physical Damage.** Where exposed, a grounding electrode conductor or its enclosure shall be securely fastened to the surface on which it is carried. Grounding electrode conductors shall be permitted to be installed on or through framing members. A 4 AWG or larger copper or aluminum grounding electrode conductor shall be protected if exposed to physical damage. A 6 AWG grounding electrode conductor that is free from exposure to physical damage shall be permitted to be run along the surface of the building construction without metal covering or protection if it is securely fastened to the construction; otherwise, it shall be protected in rigid metal conduit (RMC), intermediate metal conduit (IMC), rigid polyvinyl chloride conduit (PVC), reinforced thermosetting resin conduit (RTRC), electrical metallic tubing (EMT), or cable armor. Grounding electrode conductors smaller than 6 AWG shall be protected in (RMC), IMC, PVC, RTRC, (EMT), or cable armor.

(C) **Continuous.** Except as provided in 250.30(A)(5) and (A)(6), 250.30(B)(1), and 250.68(C), grounding electrode conductor(s) shall be installed in one continuous length without a splice or joint. If necessary, splices or connections shall be made as permitted in (1) through (4):

Changed from NEC 2008

250.64(C)(1): This was revised to clarify applicability to only wire-type grounding electrode conductors.

NEC Language

(1) Splicing of the wire-type grounding electrode conductor shall be permitted only by irreversible compression-type connectors listed as grounding and bonding equipment or by the exothermic welding process.

(2) Sections of busbars shall be permitted to be connected together to form a grounding electrode conductor.

Changed from NEC 2008

250.64(C)(3): The NEC added a new requirement specifying conditions under which a metal building frame is considered to be continuous.

NEC Language

(3) Bolted, riveted, or welded connections of structural metal frames of buildings or structures.

Changed from NEC 2008

250.64(C)(4): The NEC added a new requirement specifying conditions under which section of metal water piping are considered to be continuous.

NEC Language

(4) Threaded, welded, brazed, soldered or bolted-flange connections of metal water piping.

Changed from NEC 2008

250.64(D)(1)(3): The NEC added a new requirement covering use of **busbar** as a point of connection between a grounding electrode conductor and grounding electrode conductor taps.

NEC Language

(3) Connections to an aluminum or copper busbar not less than 6 mm × 50 mm (¼ in. × 2 in.). The busbar shall be securely fastened and shall be installed in an accessible location. Connections shall be made by a listed connector or by the exothermic welding process. If aluminum busbars are used, the installation shall comply with 250.64(A).

Changed from NEC 2008

250.64(E) **Enclosures for Grounding Electrode Conductors**: This was revised to provide references to acceptable bonding methods.

NEC Language

(E) **Enclosures for Grounding Electrode Conductors**. Ferrous metal enclosures for grounding electrode conductors shall be electrically continuous from the point of attachment to cabinets or equipment to the grounding electrode and shall be securely fastened to the ground clamp or fitting. Nonferrous metal enclosures shall not be required to be electrically continuous. Ferrous metal enclosures that are not physically continuous from cabinets or equipment to the grounding electrode shall be made electrically continuous by bonding each end of the raceway or enclosure to the grounding electrode conductor. Bonding methods in compliance with 250.92(B) for installations at service equipment locations and with 250.92(B)(2) through (B)(4) for other than service equipment locations shall apply at each end and to all intervening ferrous raceways, boxes, and enclosures between the cabinets or equipment and the grounding electrode. The bonding jumper for a grounding electrode conductor raceway or cable armor shall be the same size as, or larger than, the enclosed grounding electrode conductor. If a raceway is used as protection for a grounding electrode conductor, the installation shall comply with the requirements of the appropriate raceway article.

250.68 Grounding Electrode Conductor and Bonding Jumper Connection to Grounding Electrodes**Changed from NEC 2008**

A new section was added to address connection locations for grounding electrode conductors and bonding jumpers that can be used to extend the connection to grounding electrode(s).

NEC Language

The connection of a grounding electrode conductor at the service, at each building or structure where supplied by a feeder(s) or branch circuit(s), or at a separately derived system and associated bonding jumper(s) shall be made as specified 250.68(A) through (C).

(A) **Accessibility**. All mechanical elements used to terminate a grounding electrode conductor or bonding jumper to a grounding electrode shall be accessible.

Exception No. 1: An encased or buried connection to a concrete-encased, driven, or buried grounding electrode shall not be required to be accessible.

Exception No. 2: Exothermic or irreversible compression connections used at terminations, together with the mechanical means used to attach such terminations to fireproofed structural metal whether or not the mechanical means is reversible, shall not be required to be accessible.

(B) Effective Grounding Path. The connection of a grounding electrode conductor or bonding jumper to a grounding electrode shall be made in a manner that will ensure an effective grounding path. Where necessary to ensure the grounding path for a metal piping system used as a grounding electrode, bonding shall be provided around insulated joints and around any equipment likely to be disconnected for repairs or replacement. Bonding jumpers shall be of sufficient length to permit removal of such equipment while retaining the integrity of the grounding path.

Changed from NEC 2008

250.68(C) Metallic Water Pipe and Structural Metal: The NEC added a new requirements covering use of metal water pipe and metal building frame as a conductor to extend the grounding electrode connection inside a building or structure for the purpose of connecting grounding electrode conductors or bonding jumpers.

NEC Language

(C) Metallic Water Pipe and Structural Metal. Grounding electrode conductors and bonding jumpers shall be permitted to be connected at the following locations and used to extend the connection to an electrode(s):

(1) Interior metal water piping located not more than 1.52 m (5 ft) from the point of entrance to the building shall be permitted to be used as a conductor to interconnect electrodes that are part of the grounding electrode system.

Exception: In industrial, commercial, and institutional buildings or structures, if conditions of maintenance and supervision ensure that only qualified persons service the installation, interior metal water piping located more than 1.52 m (5 ft) from the point of entrance to the building shall be permitted as a bonding conductor to interconnect electrodes that are part of the grounding electrode system, or as a grounding electrode conductor, if the entire length, other than short sections passing perpendicularly through walls, floors, or ceilings, of the interior metal water pipe that is being used for the conductor is exposed.

(2) The structural frame of a building that is directly connected to a grounding electrode as specified in 250.52(A)(2) or 250.68(C)(2)(a), (b), or (c) shall be permitted as a bonding conductor to interconnect electrodes that are part of the grounding electrode system, or as a grounding electrode conductor.

- a. By connecting the structural metal frame to the reinforcing bars of a concrete-encased electrode, as provided in 250.52(A)(3), or ground ring as provided in 250.52(A)(4)
- b. By bonding the structural metal frame to one or more of the grounding electrodes, as specified in 250.52(A)(5) or (A)(7), that comply with (2)
- c. By other approved means of establishing a connection to earth

V. Bonding

250.92 Services

Changed from NEC 2008

Bonding requirements were added for bonding around reducer washers at raceways containing service conductors.

250.92(A) Bonding of Equipment for Services: This was revised to clarify the equipment required to be bonded.

(A) Bonding of Equipment for Services. The normally non-current-carrying metal parts of equipment indicated in 250.92(A)(1) and (A)(2) shall be bonded together.

(1) All raceways, cable trays, cablebus framework, auxiliary gutters, or service cable armor or sheath that enclose, contain, or support service conductors, except as permitted in 250.80

(2) All enclosures containing service conductors, including meter fittings, boxes, or the like, interposed in the service raceway or armor

Changed from NEC 2008

250.92(B) Bonding of Equipment for Services: This was revised to clarify the limitation on the use of standard locknuts for bonding at service equipment.

NEC Language

(B) Method of Bonding at the Service. Bonding jumpers meeting the requirements of this article shall be used around impaired connections, such as reducing washers or oversized, concentric, or eccentric knockouts. Standard locknuts or bushings shall not be the only means for the bonding required by this section but shall be permitted to be installed to make a mechanical connection of the raceway(s).

Electrical continuity at service equipment, service raceways, and service conductor enclosures shall be ensured by one of the following methods:

(1) Bonding equipment to the grounded service conductor in a manner provided in 250.8

Changed from NEC 2008

250.92(B)(2): The NEC revised terminology to improve understanding of acceptable means of bonding connection.

NEC Language

(2) Connections utilizing threaded couplings or threaded hubs on enclosures if made up wrenchtight

(3) Threadless couplings and connectors if made up tight for metal raceways and metal-clad cables

(4) Other listed devices, such as bonding-type locknuts, bushings, or bushings with bonding jumpers

250.102 Bonding Conductors and Jumpers

NEC Language

(A) Material. Bonding jumpers shall be of copper or other corrosion-resistant material. A bonding jumper shall be a wire, bus, screw, or similar suitable conductor.

(B) Attachment. Bonding jumpers shall be attached in the manner specified by the applicable provisions of 250.8 for circuits and equipment and by 250.70 for grounding electrodes.

Changed from NEC 2008

250.102(C) Size — Supply-Side Bonding Jumper: This was revised to incorporate the new term supply-side bonding jumper and to separate requirement covering single raceway and cable installations from requirement covering parallel installations.

NEC Language**(C) Size — Supply-Side Bonding Jumper.**

(1) **Size for Supply Conductors in a Single Raceway or Cable.** The supply-side bonding jumper shall not be smaller than the sizes shown in Table 250.66 for grounding electrode conductors. Where the ungrounded supply conductors are larger than 1100 kcmil copper or 1750 kcmil aluminum, the supply-side bonding jumper shall have an area not less than 12½ percent of the area of the largest set of ungrounded supply conductors.

(2) **Size for Parallel Conductor Installations.** Where the ungrounded supply conductors are paralleled in two or more raceways or cables, and an individual supply-side bonding jumper is used for bonding these raceways or cables, the size of the supply-side bonding jumper for each raceway or cable shall be selected from Table 250.66 based on the size of the ungrounded supply conductors in each raceway or cable. A single supply-side bonding jumper installed for bonding two or more raceways or cables shall be sized in accordance with 250.102(C)(1).

(3) **Different Materials.** Where the ungrounded supply conductors and the supply-side bonding jumper are of different materials (copper or aluminum), the minimum size of the supply-side bonding jumper shall be based on the assumed use of ungrounded conductors of the same material as the supply-side bonding jumper and with an ampacity equivalent to that of the installed ungrounded supply conductors.

Changed from NEC 2008

250.102(D) Size — Equipment Bonding Jumper on Load Side of an Overcurrent Device: The NEC revised this title for correlation with terminology used in the requirement.

NEC Language**(D) Size — Equipment Bonding Jumper on Load Side of an Overcurrent Device.**

The equipment bonding jumper on the load side of an overcurrent device(s) shall be sized in accordance with 250.122.

A single common continuous equipment bonding jumper shall be permitted to connect two or more raceways or cables if the bonding jumper is sized in accordance with 250.122 for the largest overcurrent device supplying circuits therein.

(E) **Installation.** Bonding jumpers or conductors and equipment bonding jumpers shall be permitted to be installed inside or outside of a raceway or an enclosure.

(1) **Inside a Raceway or an Enclosure.** If installed inside a raceway, equipment bonding jumpers and bonding jumpers or conductors shall comply with the requirements of 250.119 and 250.148.

(2) **Outside a Raceway or an Enclosure.** If installed on the outside, the length of the bonding jumper or conductor or equipment bonding jumper shall not exceed 1.8 m (6 ft) and shall be routed with the raceway or enclosure.

Exception: An equipment bonding jumper or supply-side bonding jumper longer than 1.8 m (6 ft) shall be permitted at outside pole locations for the purpose of bonding or grounding isolated sections of metal raceways or elbows installed in exposed risers of metal conduit or other metal raceway, and for bonding grounding electrodes, and shall not be required to be routed with a raceway or enclosure.

Changed from NEC 2008

250.102(E)(3) Protection: The NEC added a new requirement for physical protection of bonding jumpers and conductors.

NEC Language

(3) **Protection.** Bonding jumpers or conductors and equipment bonding jumpers shall be installed in accordance with 250.64(A) and (B).

250.104 Bonding of Piping Systems and Exposed Structural Steel

NEC Language

(A) **Metal Water Piping.** The metal water piping system shall be bonded as required in (A)(1), (A)(2), or (A)(3) of this section. The bonding jumper(s) shall be installed in accordance with 250.64(A), (B), and (E). The points of attachment of the bonding jumper(s) shall be accessible.

(1) **General.** Metal water piping system(s) installed in or attached to a building or structure shall be bonded to the service equipment enclosure, the grounded conductor at the service, the grounding electrode conductor where of sufficient size, or to the one or more grounding electrodes used. The bonding jumper(s) shall be sized in accordance with Table 250.66 except as permitted in 250.104(A)(2) and (A)(3).

(2) **Buildings of Multiple Occupancy.** In buildings of multiple occupancy where the metal water piping system(s) installed in or attached to a building or structure for the individual occupancies is metallically isolated from all other occupancies by use of nonmetallic water piping, the metal water piping system(s) for each occupancy shall be permitted to be bonded to the equipment grounding terminal of the panelboard or switchboard enclosure (other than service equipment) supplying that occupancy. The bonding jumper shall be sized in accordance with Table 250.122, based on the rating of the overcurrent protective device for the circuit supplying the occupancy.

(3) **Multiple Buildings or Structures Supplied by a Feeder(s) or Branch Circuit(s).** The metal water piping system(s) installed in or attached to a building or structure shall be bonded to the building or structure disconnecting means enclosure where located at the building or structure, to the equipment grounding conductor run with the supply conductors, or to the one or more grounding electrodes used. The bonding jumper(s) shall be sized in accordance with 250.66, based on the size of the feeder or branch circuit conductors that supply the building. The bonding jumper shall not be required to be larger than the largest ungrounded feeder or branch circuit conductor supplying the building.

(B) **Other Metal Piping.** If installed in, or attached to, a building or structure, a metal piping system(s), including gas piping, that is likely to become energized shall be bonded to the service equipment enclosure; the grounded conductor at the service; the grounding electrode conductor, if of sufficient size; or to one or more grounding electrodes used. The bonding conductor(s) or jumper(s) shall be sized in accordance with 250.122, using the rating of the circuit that is likely to energize the piping system(s). The equipment grounding conductor for the circuit that is likely to energize the piping

shall be permitted to serve as the bonding means. The points of attachment of the bonding jumper(s) shall be accessible.

Informational Note No. 1: Bonding all piping and metal air ducts within the premises will provide additional safety.

Changed from NEC 2008

250.104(B) **Informational Note No. 2:** The NEC added a new informational note referring to requirements in NFPA 54 covering gas piping.

NEC Language

Informational Note No. 2: Additional information for gas piping systems can be found in Section 7.13 of NFPA 54-2009, National Fuel Gas Code.

Changed from NEC 2008

250.104(C) **Structural Metal:** This was revised to cover buildings or structures supplied by a feeder or branch circuit and to include provision under which a bonding jumper connection is not required to be accessible.

NEC Language

(C) **Structural Metal.** Exposed structural metal that is interconnected to form a metal building frame and is not intentionally grounded or bonded and is likely to become energized shall be bonded to the service equipment enclosure; the grounded conductor at the service; the disconnecting means for buildings or structures supplied by a feeder or branch circuit; the grounding electrode conductor, if of sufficient size; or to one or more grounding electrodes used. The bonding jumper(s) shall be sized in accordance with Table 250.66 and installed in accordance with 250.64(A), (B), and (E). The points of attachment of the bonding jumper(s) shall be accessible unless installed in compliance with 250.68(A), Exception No. 2.

Changed from NEC 2008

250.104(D)(3) **Common Grounding Electrode Conductor:** This was revised to specify location of structural metal bonding connection where a common grounding electrode conductor is used for multiple separately derived systems.

NEC Language

(3) **Common Grounding Electrode Conductor.** Where a common grounding electrode conductor is installed for multiple separately derived systems as permitted by 250.30(A)(6), and exposed structural metal that is interconnected to form the building frame or interior metal piping exists in the area served by the separately derived system, the metal piping and the structural metal member shall be bonded to the common grounding electrode conductor in the area served by the separately derived system.

Exception: A separate bonding jumper from each derived system to metal water piping and to structural metal members shall not be required where the metal water piping and the structural metal members in the area served by the separately derived system are bonded to the common grounding electrode conductor.

250.106 Lightning Protection Systems

Changed from NEC 2008

250.106 Informational Note: The NEC revised the terminology (strike termination devices) for correlation NFPA 780.

NEC Language

The lightning protection system ground terminals shall be bonded to the building or structure grounding electrode system.

Informational Note No. 1: See 250.60 for use of **strike termination devices**. For further information, see NFPA 780-2011, Standard for the Installation of Lightning Protection Systems, which contains detailed information on grounding, bonding, and sideflash distance from lightning protection systems.

Informational Note No. 2: Metal raceways, enclosures, frames, and other non-current-carrying metal parts of electrical equipment installed on a building equipped with a lightning protection system may require bonding or spacing from the lightning protection conductors in accordance with NFPA 780-2011, Standard for the Installation of Lightning Protection Systems.

VI. Equipment Grounding and Equipment Grounding Conductors

Changed from NEC 2008

250.110: This is an editorial revisions for clarity of requirements

NEC Language

250.110 Equipment Fastened in Place (Fixed) or Connected by Permanent Wiring Methods.

Exposed, normally non-current-carrying metal parts of fixed equipment supplied by or enclosing conductors or components that are likely to become energized shall be connected to an equipment grounding conductor under any of the following conditions:

- (1) Where within 2.5 m (8 ft) vertically or 1.5 m (5 ft) horizontally of ground or grounded metal objects and subject to contact by persons
- (2) Where located in a wet or damp location and not isolated
- (3) Where in electrical contact with metal
- (4) Where in a hazardous (classified) location as covered by Articles 500 through 517
- (5) Where supplied by a wiring method that provides an equipment grounding conductor, except as permitted by 250.86 Exception No. 2 for short sections of metal enclosures
- (6) Where equipment operates with any terminal at over 150 volts to ground

Exception No. 1: If exempted by special permission, the metal frame of electrically heated appliances that have the frame permanently and effectively insulated from ground shall not be required to be grounded.

Exception No. 2: Distribution apparatus, such as transformer and capacitor cases, mounted on wooden poles at a height exceeding 2.5 m (8 ft) above ground or grade level shall not be required to be grounded.

Exception No. 3: Listed equipment protected by a system of double insulation, or its equivalent, shall not be required to be connected to the equipment grounding conductor. Where such a system is employed, the equipment shall be distinctively marked.

250.114 Equipment Connected by Cord and Plug

NEC Language

Under any of the conditions described in 250.114(1) through (4), exposed, normally non-current-carrying metal parts of cord-and-plug-connected equipment shall be connected to the equipment grounding conductor.

Exception: Listed tools, listed appliances, and listed equipment covered in 250.114(2) through (4) shall not be required to be connected to an equipment grounding conductor where protected by a system of double insulation or its equivalent. Double insulated equipment shall be distinctively marked.

(1) **In hazardous (classified) locations** (see Articles 500 through 517)

(2) **Where operated at over 150 volts to ground**

Exception No. 1: Motors, where guarded, shall not be required to be connected to an equipment grounding conductor.

Exception No. 2: Metal frames of electrically heated appliances, exempted by special permission, shall not be required to be connected to an equipment grounding conductor, in which case the frames shall be permanently and effectively insulated from ground.

(3) **In residential occupancies:**

a. Refrigerators, freezers, and air conditioners

Changed from NEC 2008

250.114(3)(b): This was revised to include ranges installed in residential occupancies.

NEC Language

b. Clothes-washing, clothes-drying, dish-washing machines; ranges; kitchen waste disposers; information technology equipment; sump pumps and electrical aquarium equipment

250.118 Types of Equipment Grounding Conductors

NEC Language

The equipment grounding conductor run with or enclosing the circuit conductors shall be one or more or a combination of the following:

(1) **A copper, aluminum, or copper-clad aluminum conductor.** This conductor shall be solid or stranded; insulated, covered, or bare; and in the form of a wire or a busbar of any shape.

(2) **Rigid metal conduit.**

(3) **Intermediate metal conduit.**

(4) **Electrical metallic tubing.**

(5) **Listed flexible metal conduit** meeting all the following conditions:

a. The conduit is terminated in listed fittings.

b. The circuit conductors contained in the conduit are protected by overcurrent devices rated at 20 amperes or less.

c. The combined length of flexible metal conduit and flexible metallic tubing and liquidtight flexible metal conduit in the same ground-fault current path does not exceed 1.8 m (6 ft).

Changed from NEC 2008

250.118(5)(d): This was revised to clarify conditions under which equipment is considered to have a "flexible" connection.

NEC Language

d. If used to connect equipment where flexibility is necessary to minimize the transmission of vibration from equipment or to provide flexibility for equipment that requires movement after installation, an equipment grounding conductor shall be installed.

(6) Listed liquidtight flexible metal conduit meeting all the following conditions:

a. The conduit is terminated in listed fittings.

b. For metric designators 12 through 16 (trade sizes 3/8 through 1/2), the circuit conductors contained in the conduit are protected by overcurrent devices rated at 20 amperes or less.

c. For metric designators 21 through 35 (trade sizes 3/4 through 1 1/4), the circuit conductors contained in the conduit are protected by overcurrent devices rated not more than 60 amperes and there is no flexible metal conduit, flexible metallic tubing, or liquidtight flexible metal conduit in trade sizes metric designators 12 through 16 (trade sizes 3/8 through 1/2) in the ground-fault current path.

d. The combined length of flexible metal conduit and flexible metallic tubing and liquidtight flexible metal conduit in the same ground-fault current path does not exceed 1.8 m (6 ft).

Changed from NEC 2008

250.118(6)(e): This was revised to clarify conditions under which equipment is considered to have a "flexible" connection.

NEC Language

e. If used to connect equipment where flexibility is necessary to minimize the transmission of vibration from equipment or to provide flexibility for equipment that requires movement after installation, an equipment grounding conductor shall be installed.

(7) Flexible metallic tubing where the tubing is terminated in listed fittings and meeting the following conditions:

a. The circuit conductors contained in the tubing are protected by overcurrent devices rated at 20 amperes or less.

b. The combined length of flexible metal conduit and flexible metallic tubing and liquidtight flexible metal conduit in the same ground-fault current path does not exceed 1.8 m (6 ft).

(8) Armor of Type AC cable as provided in 320.108.

(9) The copper sheath of mineral-insulated, metal-sheathed cable.

Changed from NEC 2008

250.118(10): This was revised to clarify requirements covering conditions under which Type MC cable provides an effective ground-fault current return path.

NEC Language

(10) Type MC cable that provides an effective ground-fault current path in accordance with one or more of the following:

- a. It contains an insulated or uninsulated equipment grounding conductor in compliance with 250.118(1)
- b. The combined metallic sheath and uninsulated equipment grounding/bonding conductor of interlocked metal tape-type MC cable that is listed and identified as an equipment grounding conductor
- c. The metallic sheath or the combined metallic sheath and equipment grounding conductors of the smooth or corrugated tube-type MC cable that is listed and identified as an equipment grounding conductor

(11) Cable trays as permitted in 392.10 and 392.60.

(12) Cablebus framework as permitted in 370.3.

(13) Other listed electrically continuous metal raceways and listed auxiliary gutters.

(14) Surface metal raceways listed for grounding.

Informational Note: For effective ground-fault current path, see 250.2 Definition.

250.119 Identification of Equipment Grounding Conductors

NEC Language

Unless required elsewhere in this Code, equipment grounding conductors shall be permitted to be bare, covered, or insulated. Individually covered or insulated equipment grounding conductors shall have a continuous outer finish that is either green or green with one or more yellow stripes except as permitted in this section. Conductors with insulation or individual covering that is green, green with one or more yellow stripes, or otherwise identified as permitted by this section shall not be used for ungrounded or grounded circuit conductors.

Changed from NEC 2008

250.119 Exception: This was revised to clarify conditions under which a conductor with green colored insulation is permitted as a circuit conductor in remote-control, signaling, fire alarm, or communications cables and circuits.

NEC Language

Exception: Power-limited Class 2 or Class 3 cables, power-limited fire alarm cables, or communications cables containing only circuits operating at less than 50 volts where connected to equipment not required to be grounded in accordance with 250.112(I) shall be permitted to use a conductor with green insulation or green with one or more yellow stripes for other than equipment grounding purposes.

250.120 Equipment Grounding Conductor Installation

NEC Language

An equipment grounding conductor shall be installed in accordance with 250.120(A), (B), and (C).

(A) Raceway, Cable Trays, Cable Armor, Cablebus, or Cable Sheaths. Where it consists of a raceway, cable tray, cable armor, cablebus framework, or cable sheath or where it is a wire within a raceway or cable, it shall be installed in accordance with the

applicable provisions in this Code using fittings for joints and terminations approved for use with the type raceway or cable used. All connections, joints, and fittings shall be made tight using suitable tools.

Informational Note: See the UL guide information on FHIT systems for equipment grounding conductors installed in a raceway that are part of an electrical circuit protective system or a fire-rated cable listed to maintain circuit integrity.

(B) Aluminum and Copper-Clad Aluminum Conductors. Equipment grounding conductors of bare or insulated aluminum or copper-clad aluminum shall be permitted. Bare conductors shall not come in direct contact with masonry or the earth or where subject to corrosive conditions. Aluminum or copper-clad aluminum conductors shall not be terminated within 450 mm (18 in.) of the earth.

Changed from NEC 2008

250.120(C) Equipment Grounding Conductors Smaller Than 6 AWG: This was revised to specifically include equipment grounding conductors of dc circuits that are run separately from the circuit conductors.

NEC Language

(C) Equipment Grounding Conductors Smaller Than 6 AWG. Where not routed with circuit conductors as permitted in 250.130(C) and 250.134(B) Exception No. 2, equipment grounding conductors smaller than 6 AWG shall be protected from physical damage by an identified raceway or cable armor unless installed within hollow spaces of the framing members of buildings or structures and where not subject to physical damage.

250.121 Use of Equipment Grounding Conductors

Changed from NEC 2008

250.121: The NEC added a new requirement prohibiting an equipment grounding conductor from also being used as a grounding electrode conductor.

This new statement prevents an equipment grounding conductor from being used as a grounding electrode conductor. This new section clarifies that grounding electrode conductors and equipment grounding conductors serve different purposes in the electrical safety system. They are sized differently and have different installation requirements.

Equipment grounding conductors do not normally carry current, while a grounding electrode conductor may normally carry current since it is often in parallel with the neutral conductor.

NEC Language

An equipment grounding conductor shall not be used as a grounding electrode conductor.

250.122 Size of Equipment Grounding Conductors

Changed from NEC 2008

250.122(A) General: The NEC added a new requirement permitting a sectioned equipment grounding conductor in a multiconductor cable.

NEC Language

(A) **General.** Copper, aluminum, or copper-clad aluminum equipment grounding conductors of the wire type shall not be smaller than shown in Table 250.122, but in no case shall they be required to be larger than the circuit conductors supplying the equipment. Where a cable tray, a raceway, or a cable armor or sheath is used as the equipment grounding conductor, as provided in 250.118 and 250.134(A), it shall comply with 250.4(A)(5) or (B)(4).

Equipment grounding conductors shall be permitted to be sectioned within a multiconductor cable, provided the combined circular mil area complies with Table 250.122.

(B) **Increased in Size.** Where ungrounded conductors are increased in size, equipment grounding conductors, where installed, shall be increased in size proportionately according to the circular mil area of the ungrounded conductors.

(C) **Multiple Circuits.** Where a single equipment grounding conductor is run with multiple circuits in the same raceway, cable, or cable tray, it shall be sized for the largest overcurrent device protecting conductors in the raceway, cable, or cable tray. Equipment grounding conductors installed in cable trays shall meet the minimum requirements of 392.10(B)(1)(c).

(D) **Motor Circuits.** Equipment grounding conductors for motor circuits shall be sized in accordance with (D)(1) or (D)(2).

(1) **General.** The equipment grounding conductor size shall not be smaller than determined by 250.122(A) based on the rating of the branch-circuit short-circuit and ground-fault protective device.

(2) **Instantaneous-Trip Circuit Breaker and Motor Short-Circuit Protector.** Where the overcurrent device is an instantaneous-trip circuit breaker or a motor short-circuit protector, the equipment grounding conductor shall be sized not smaller than that given by 250.122(A) using the maximum permitted rating of a dual element time-delay fuse selected for branch-circuit short-circuit and ground-fault protection in accordance with 430.52(C)(1), Exception No. 1.

(E) **Flexible Cord and Fixture Wire.** The equipment grounding conductor in a flexible cord with the largest circuit conductor 10 AWG or smaller, and the equipment grounding conductor used with fixture wires of any size in accordance with 240.5, shall not be smaller than 18 AWG copper and shall not be smaller than the circuit conductors. The equipment grounding conductor in a flexible cord with a circuit conductor larger than 10 AWG shall be sized in accordance with Table 250.122.

Changed from NEC 2008

250.122(F) Conductors in Parallel: This was revised to include parallel conductors installed in cable tray.
--

NEC Language

(F) **Conductors in Parallel.** Where conductors are installed in parallel in multiple raceways or cables as permitted in 310.10(H), the equipment grounding conductors, where used, shall be installed in parallel in each raceway or cable. Where conductors are installed in parallel in the same raceway, cable, or cable tray as permitted in 310.10(H), a single equipment grounding conductor shall be permitted. Equipment

grounding conductors installed in cable tray shall meet the minimum requirements of 392.10(B)(1)(c).

Each equipment grounding conductor shall be sized in compliance with 250.122.

(G) **Feeder Taps.** Equipment grounding conductors run with feeder taps shall not be smaller than shown in Table 250.122 based on the rating of the overcurrent device ahead of the feeder but shall not be required to be larger than the tap conductors.

Rating or Setting of Automatic Overcurrent Device in Circuit Ahead of Equipment, Conduit, etc., Not Exceeding (Amperes)	Size (AWG or kcmil)	
	Copper	Aluminum or Copper-Clad Aluminum*
15	14	12
20	12	10
60	10	8
100	8	6
200	6	4
300	4	2
400	3	1
500	2	1/0
600	1	2/0
800	1/0	3/0
1000	2/0	4/0
1200	3/0	250
1600	4/0	350
2000	250	400
2500	350	600
3000	400	600
4000	500	750
5000	700	1200
6000	800	1200

Note: Where necessary to comply with 250.4(A)(5) or (B)(4), the equipment grounding conductor shall be sized larger than given in this table.

*See installation restrictions in 250.120.

NEC 2011

VII. Methods of Equipment Grounding

250.146 Connecting Receptacle Grounding Terminal to Box

NEC Language

An equipment bonding jumper shall be used to connect the grounding terminal of a grounding-type receptacle to a grounded box unless grounded as in 250.146(A) through (D). The equipment bonding jumper shall be sized in accordance with Table 250.122 based on the rating of the overcurrent device protecting the circuit conductors.

Changed from NEC 2008

250.146(A) Surface-Mounted Box: This was revised to include nuts as a locking means for cover fasteners.

NEC Language

(A) **Surface-Mounted Box.** Where the box is mounted on the surface, direct metal-to-metal contact between the device yoke and the box or a contact yoke or device that complies with 250.146(B) shall be permitted to ground the receptacle to the box. At least one of the insulating washers shall be removed from receptacles that do not have a contact yoke or device that complies with 250.146(B) to ensure direct metal-to-metal contact. This provision shall not apply to cover-mounted receptacles unless the box and cover combination are listed as providing satisfactory ground continuity between the box and the receptacle. A listed exposed work cover shall be permitted to be the grounding and bonding means when (1) the device is attached to the cover with at least two fasteners that are permanent (such as a rivet) or have a thread locking or screw or nut locking means and (2) when the cover mounting holes are located on a flat non-raised portion of the cover.

X. Grounding of Systems and Circuits of over 1 kV

Changed from NEC 2008

250 Part X: The NEC revised the title and other sections in Part X for consistency with other NEC requirements and with industry standards relating to equipment rated "over 1 kV."

250.186 Impedance Grounded Neutral Systems

NEC Language

Impedance grounded neutral systems in which a grounding impedance, usually a resistor, limits the ground-fault current shall be permitted where all of the following conditions are met:

- (1) The conditions of maintenance and supervision ensure that only qualified persons service the installation.
- (2) Ground detectors are installed on the system.
- (3) Line-to-neutral loads are not served.

Impedance grounded neutral systems shall comply with the provisions of 250.186(A) through (D).

Changed from NEC 2008

250.186(A) **Location:** This was revised to specify required location for grounding impedance.

NEC Language

(A) **Location.** The grounding impedance shall be inserted in the grounding electrode conductor between the grounding electrode of the supply system and the neutral point of the supply transformer or generator.

(B) **Identified and Insulated.** The neutral conductor of an impedance grounded neutral system shall be identified, as well as fully insulated with the same insulation as the phase conductors.

(C) **System Neutral Conductor Connection.** The system neutral conductor shall not be connected to ground, except through the neutral grounding impedance.

(D) **Equipment Grounding Conductors.** Equipment grounding conductors shall be permitted to be bare and shall be electrically connected to the ground bus and grounding electrode conductor.

250.190 Grounding of Equipment

Changed from NEC 2008

250.190: This was revised to include requirements for equipment grounding, grounding electrode conductors, and equipment grounding conductors.

NEC Language

(A) **Equipment Grounding.** All non-current-carrying metal parts of fixed, portable, and mobile equipment and associated fences, housings, enclosures, and supporting structures shall be grounded.

Exception: Where isolated from ground and located such that any person in contact with ground cannot contact such metal parts when the equipment is energized, the metal parts shall not be required to be grounded.

Informational Note: See 250.110, Exception No. 2, for pole-mounted distribution apparatus.

(B) **Grounding Electrode Conductor.** If a grounding electrode conductor connects non-current-carrying metal parts to ground, the grounding electrode conductor shall be sized in accordance with Table 250.66, based on the size of the largest ungrounded service, feeder, or branch-circuit conductors supplying the equipment. The grounding electrode conductor shall not be smaller than 6 AWG copper or 4 AWG aluminum.

(C) **Equipment Grounding Conductor.** Equipment grounding conductors shall comply with 250.190(C)(1) through (C)(3).

(1) **General.** Equipment grounding conductors that are not an integral part of a cable assembly shall not be smaller than 6 AWG copper or 4 AWG aluminum.

Changed from NEC 2008

250.190(C)(2) **Shielded Cables:** The NEC added new requirements covering use of cable shield as equipment grounding conductor.

NEC Language

(2) **Shielded Cables.** The metallic insulation shield encircling the current carrying conductors shall be permitted to be used as an equipment grounding conductor, if it is rated for clearing time of ground fault current protective device operation without damaging the metallic shield. The metallic tape insulation shield and drain wire insulation shield shall not be used as an equipment grounding conductor for solidly grounded systems.

(3) **Sizing.** Equipment grounding conductors shall be sized in accordance with Table 250.122 based on the current rating of the fuse or the overcurrent setting of the protective relay.

Informational Note: The overcurrent rating for a circuit breaker is the combination of the current transformer ratio and the current pickup setting of the protective relay.

250.191 Grounding System at Alternating-Current Substations

Changed from NEC 2008

The NEC added a new requirement covering grounding system at ac substations operating over 1 kV.

NEC Language

For ac substations, the grounding system shall be in accordance with Part III of Article 250.

Informational Note: For further information on outdoor ac substation grounding, see ANSI/IEEE 80-2000, IEEE Guide for Safety in AC Substation Grounding.

Article 280 — Surge Arresters, Over 1 kV

This article covers general requirements, installation requirements, and connection requirements for surge arresters installed on premises wiring systems over 1 kV.

Changed from NEC 2008

280: This was revised by deleting or replacing the term grounding conductor to correlate with removal of the term grounding conductor from Article 100.

280.5 (2008): Deleted requirement for listed surge arresters.

Article 285 — Surge-Protective Devices (SPDs), 1 kV or Less

Article 285 covers the general requirements, installation requirements, and connection requirements for surge protective devices (SPDs) permanently installed on both the line side and load side of service equipment.

Changed from NEC 2008

This was revised by deleting or replacing the term grounding conductor to correlate with removal of the term grounding conductor from Article 100.

III. Connecting SPDs

285.25 Type 3 SPDs

Changed from NEC 2008

285.25: This was revised to require minimum connection separation if so specified in manufacturer's installation and application instructions.

NEC Language

Type 3 SPDs (TVSSs) shall be permitted to be installed on the load side of branch-circuit overcurrent protection up to the equipment served. If included in the manufacturer's instructions, the Type 3 SPD connection shall be a minimum 10 m (30 ft) of conductor distance from the service or separately derived system disconnect.

Final Exam

1. True or False: The intent of the NEC is to serve as a teaching manual for untrained individuals.
 - a. True
 - b. False

2. The familiar term **fine print notes (FPN)** has been removed throughout the Code and replaced with _____. "Fine print" refers to a type size, rather than clearly portraying its advisory nature.
 - a. Informational Notes
 - b. Footnotes
 - c. Addendums
 - d. Clarifications

3. True or False: **Informative annexes** are part of the enforceable requirements of the NEC.
 - a. True
 - b. False

4. True or False: **Branch Circuit, Appliance** is a branch circuit that supplies energy to one or more outlets to which appliances are to be connected and that has permanently connected luminaires that are not a part of an appliance.
 - a. True
 - b. False

5. True or False: Wires in concealed raceways are not considered concealed, because they may become accessible by withdrawing them.
 - a. True
 - b. False

6. **Ampacity** is the _____ current, in amperes, that a conductor can carry continuously under the conditions of use without exceeding its temperature rating.
 - a. Maximum
 - b. Minimum
 - c. Approximate
 - d. None of the above

7. **Interrupting Rating** is the highest current at rated voltage that a device is _____ to interrupt under standard test conditions.
 - a. Intended
 - b. Identified
 - c. Expected
 - d. All of the above

8. According to the 2011 NEC, a **Kitchen** is an area with a sink and permanent _____ for food preparation and cooking.
 - a. Facilities
 - b. Provisions
 - c. Appliances
 - d. All of the above

9. **Service Lateral**. This definition applies to:
 - a. The underground conductors between the utility electric supply system and the service point.

- b. The underground conductors between the service point and the first point of connection to the service-entrance conductors in a terminal box, meter, or other enclosure, inside or outside the building wall.
- c. The overhead conductors between the service point and the first point of connection to the service-entrance conductors at the building or other structure.
- d. All of the above

10. The NEC now specifies that all working spaces about service equipment, switchboards, panelboards, or motor control centers installed indoors shall be illuminated with:

- a. Only an automatic sensor switch
- b. Only with a manual switch
- c. Automatic circuits, but must also be controlled by a circuit which can operate in a manual mode.
- d. None of the above

11. According to **110.31(A)(1) Enclosure for Electrical Installations—Walls and Roof**, the walls and roof shall be constructed of materials that have adequate structural strength for the conditions, with a minimum fire rating of _____.

- a. 1 hour
- b. 2 hours
- c. 3 hours
- d. 6 hours

12. According to **110.31(A)(3) Doors**, each doorway leading into a vault from the building interior shall be provided with a tight-fitting door that has a minimum fire rating of 3 hours. Where the vault is protected with automatic sprinkler, water spray, carbon dioxide, or halon, construction with a _____ rating shall be permitted.

- a. 1-hour
- b. 2-hours
- c. 3-hours
- d. 4-hours

13. According to **110.31(A)(4) Locks**, doors shall be equipped with locks, and doors shall be kept locked, with access allowed only to _____.

- a. Supervising personnel
- b. Electricians
- c. Qualified persons
- d. All of the above

14. A typical 3-hour construction is _____ thick reinforced concrete.

- a. 3-inch
- b. 6-inch
- c. 4-inch
- d. None of the above

15. Chapter 2 of the NEC is primarily concerned with:

- a. Installing Wiring to Code
- b. Correctly sizing and protecting circuits
- c. Correctly install the conductors that make up those circuits
- d. All of the above

16. Article 200 provides requirements for the following:

- a. Identification of terminals
- b. Grounded conductors in premises wiring systems
- c. Identification of grounded conductors

d. All of the above

17. Neutral conductors shall not be used for _____, unless specifically permitted elsewhere in this Code.

- a. For more than one branch circuit
- b. For more than one multiwire branch circuit
- c. For more than one set of ungrounded feeder conductors
- d. All of the above

18. **Under 200.6—Means of Identifying Grounded Conductors, Sizes 6 AWG or Smaller**, an insulated grounded conductor of 6 AWG or smaller shall be identified by one of the following means:

- a. By a continuous white outer finish
- b. By a continuous gray outer finish
- c. By three continuous white stripes along its entire length on other than green insulation
- d. All of the above

19. An insulated grounded conductor 4 AWG or larger shall be identified by one of the following means:

- a. A continuous black outer finish
- b. A continuous gray outer finish
- c. Three continuous black stripes along its entire length on other than green insulation
- d. None of the above

20. True or False: The NEC re-identified that switch loops can be used for the supply to the switch and as a return conductor from the switch to the outlet.

- a. True
- b. False

21. According to **210.5(C) (2) Identification of Ungrounded Conductors—Means of Identification**, the means of identification shall be permitted to be by:

- a. Separate color coding
- b. Marking tape
- c. Tagging
- d. All of the above

22. True or False: Where two or more branch circuits supply devices or equipment on the same yoke, a means to simultaneously disconnect the ungrounded conductors supplying those devices shall be provided at the point at which the branch circuits originate.

- a. True
- b. False

23. With the exception that receptacles that are not readily accessible and are supplied by a branch circuit dedicated to electric snow-melting, deicing, or pipeline and vessel heating equipment shall be permitted to be installed in accordance with 426.28 or 427.22, as applicable, **Sections 210.8(A)** for dwelling units, and **210.8(B)** for non-dwelling units will now require that GFCI receptacles be installed: _____.

- a. Behind refrigerators
- b. In a closet
- c. In a readily accessible location
- d. In a fuse panel

24. According to **210.8(A)(7) Sinks**, a GFCI is now required for all 125-volt, single-phase, 15- and 20- ampere receptacles installed within _____ of the outside edge of a dwelling unit sink (not just laundry, utility or wet bar sinks).

- a. 2 feet
- b. 3 feet
- c. 4 feet
- d. 6 feet

25. True or False: In **210.8(B)(7) Locker rooms with associated showering facilities**, receptacles installed in locker rooms now require GFCI protection.

- a. True
- b. False

26. According to **210.19(A)(2)**, conductors of branch circuits supplying more than one receptacle for cord-and-plug-connected portable loads shall have an ampacity _____ the rating of the branch circuit.

- a. Equal to
- b. Of not less than
- c. Greater than
- d. All of the above

27. **210.52 (C) (3) Peninsular Countertop Spaces**. At least one receptacle outlet shall be installed at each peninsular countertop space with a long dimension of _____ or greater and a short dimension of _____ or greater. A peninsular countertop is measured from the connecting edge.

- a. 24 in. or greater — 12 in. or greater
- b. 12 in or greater — 6 in or greater
- c. 6 in. or greater — 3 in or greater
- d. None of the above

28. True or False: According to **210.52 (C) (5)**, listed receptacle outlet assemblies are now permitted to be installed on or in the kitchen and bathroom countertops to serve as the required countertop receptacles.

- a. True
- b. False

29. According to **210.52(D) Bathrooms**, the receptacle outlet shall be located on a wall or partition that is adjacent to the basin or basin countertop, located on the countertop, or installed on the side or face of the basin cabinet not more than _____ below the countertop. Receptacle outlet assemblies listed for the application shall be permitted to be installed in the countertop.

- a. 3 feet
- b. 12 inches
- c. 1 foot
- d. 2 feet

30. Under **210.52(E)(3) Balconies, Decks, and Porches**, balconies, decks, and porches that are accessible from inside the dwelling unit shall have at least one receptacle outlet installed within the perimeter of the balcony, deck, or porch. The receptacle shall not be located more than _____ above the balcony, deck, or porch surface.

- a. 3 feet
- b. 4 feet
- c. 6 feet
- d. 6 ½ feet

31. According to **210.52(G)(1)**, at least ___ receptacle outlet, in addition to those for specific equipment, shall be installed in each basement, in each attached garage, and in each detached garage or accessory building with electric power.

- a. One
- b. Two
- c. Three
- d. Four

32. True or False: According to **220.5(B) Fractions of an Ampere**, calculations are not permitted to be rounded to the nearest whole ampere.

- a. True
- b. False

33. Under **220.18(B) Inductive and LED Lighting Loads**, for circuits supplying lighting units that have ballasts, transformers, autotransformers, or LED drivers, the calculated load shall be based _____.

- a. On the total ampere ratings of such units
- b. On the total watts of the lamps
- c. The minimum ampere ratings of such units
- d. All of the above

34. **225.30 Number of Supplies** states: Where a branch circuit or feeder originates in a property, under single management with additional buildings or other structures, only _____ feeder(s) or branch circuit shall be permitted to supply power back to the original building or structure, unless permitted in 225.30(A) through (E).

- a. One
- b. Two
- c. Three
- d. Four

35. According to **230.24(A) Exception No. 5**, where the voltage between conductors does not exceed 300 and the roof area is guarded or isolated, a reduction in clearance to _____ shall be permitted.

- a. 1 foot
- b. Two feet
- c. Three feet
- d. None of the above

36. True or False: The NEC added a new exception **220.43(B)** permitting calculation of **track lighting load to be based on rating of a device limiting current to the track.**

- a. True
- b. False

37. True or False: The NEC added a new **225.52(B)** exception requiring simultaneous disconnection of ungrounded conductors where fused cutouts are used as disconnecting means.

- a. True
- b. False

38. With **230.24(A) Exception No. 5**, the NEC added a new condition for reduced overhead clearance where the roof area is guarded or isolated and the voltage between conductors is 300 volts or less. Service conductors are generally required to have a vertical clearance of not less than 2.5 m (8 ft) above the roof surface. A reduction of clearance for overhead service conductors above a roof of _____ is permitted where the roof area is guarded or isolated.

- a. 6 feet
- b. 4 feet
- c. 3 feet
- d. None of the above

39. The NEC added a new exception **230.42** permitting grounded conductors to be sized at _____ of the continuous and noncontinuous load.

- a. 70%
- b. 80%
- c. 90%
- d. 100%

40. Under **230.54(B) Service-Entrance Cables Equipped with Service Head or Gooseneck**, the NEC states that service-entrance cables shall be equipped with a service head listed for use in wet locations. The Exception states that Type SE cable _____.

- a. Need not comply
- b. Shall be permitted to be formed in a gooseneck and taped with a self-sealing weather-resistant thermoplastic
- c. Cannot be used
- d. None of the above

41. According to **230.92 Locked Service Overcurrent Devices**, where the service overcurrent devices are locked or sealed or are not readily accessible to the occupant, branch-circuit or feeder overcurrent devices shall be _____.

- a. Installed on the load side
- b. Mounted in a readily accessible location
- c. Of lower ampere rating than the service overcurrent device
- d. All of the above

42. True or False: **240.4(B) Overcurrent Devices Rated 800 Amperes or Less (1)** specifies that that "rounding up" to the next standard size overcurrent protective device conductors being protected are part of a branch circuit supplying more than one receptacle for cord-and-plug-connected portable loads.

- a. True
- b. False

43. True or False: **240.15(B)(2) Grounded Single-Phase Alternating-Current Circuits** was revised for correlation with ac voltages specified in UL 489. It specifies that, in grounded systems, individual single-pole circuit breakers rated 120/240 volts ac, with identified handle ties, shall be permitted as the protection for each ungrounded conductor for line-to-line connected loads for single-phase circuits.

- a. True
- b. False

44. **240.87 Noninstantaneous Trip** states: Where a circuit breaker is utilized without an instantaneous trip, one of the following or approved equivalent means shall be provided:

- a. Zone-selective interlocking
- b. Differential relaying
- c. Energy-reducing maintenance switching with local status indicator
- d. All of the above

45. **240.91(B) Devices Rated Over 800 Amperes**: For supervised industrial installations the NEC now permits "rounding up" applications in circuits protected by overcurrent protective devices rated more than 800 amperes. Where the overcurrent device is rated over 800 amperes, the ampacity of the conductors it protects shall be equal to or greater than _____ of the rating of the overcurrent device specified in 240.6 in accordance with (B)(1) and (2).

- a. 80%
- b. 85%
- c. 90%

d. 95%

46. Under **250.8 Connection of Grounding and Bonding Equipment. B) Methods Not Permitted**, equipment grounding conductors, grounding electrode conductors, and bonding jumpers shall NOT be connected by:

- a. Terminal bars
- b. Connection devices or fittings that depend solely on solder
- c. Pressure connectors listed as grounding and bonding equipment
- d. Machine screw-type fasteners that engage not less than two threads or are secured with a nut

47. **250.24(C) Grounded Conductor Brought to Service Equipment.**

(3) Delta-Connected Service states: The grounded conductor of a 3-phase, 3-wire delta service shall have an ampacity _____ than that of the ungrounded conductors.

- a. 95%
- b. 110%
- c. Not less
- d. None of the above

48. **250.30(A)(2) Supply-Side Bonding Jumper** was revised to require installation of supply-side bonding jumper between the source enclosure and an enclosure containing the first system disconnecting means or overcurrent protective device, and to clarify that the supply-side bonding jumper can be:

- a. Nonflexible metal raceway
- b. A wire
- c. A bus
- d. All of the above

49. Under **250.53(A)(3) Supplemental Electrode**, the NEC added a new requirement to provide spacing requirement specific to supplemental electrodes. If multiple rod, pipe, or plate electrodes are installed to meet the requirements of this section, they shall not be less than _____ apart.

- a. 6 feet
- b. 5 feet
- c. 4 feet
- d. 3 feet

50. A Separately Derived System has no direct connection from circuit conductors of one system to circuit conductors of another system, other than through the earth and _____.

- a. Metal enclosures
- b. Metallic raceways
- c. Equipment grounding conductors
- d. All of the above

Attachment #2: Instructor Information

Course Instructor:

Joe Crump

Florida Certified Electrical Contractor AC# 2712320

Mr. Crump's resume is attached for review.

Joe H. Crump

1900 Winchester Road North, Saint Petersburg FL 33710
Home (727) 343-0713 Work (727) 224-8200

Experience

L. Crump Electric, Saint Petersburg, Fl.

Owner, 1973-Present

Schedule and control up to 75 full time employees. Residential, commercial, and industrial appraiser.

U.S. Army Corp of Engineering, United States Army

Electrical Engineer. 1969-1972

Designed and implemented wiring for military bases. Supervised quality control.

Certification

1966 Journeyman Electrical Certified

1969 Master Electrician — City of Saint Petersburg, FL

1969 United States Civil Service — Skilled Electrician

1970 Department of the Army — Construction Foreman Course

1990 Master Electrician — State of Florida

1991 Southern Building Code Congress — Residential Electrical Inspector

1992 Southern Building Code Congress — Commercial Electrical Inspector

1992 Building Officials and Code Administrators International, Inc. — Certified as a Electrical Inspector

1992 Southern Building Code Congress — Certified as Electrical inspector

1992 Grounding and Bonding Certified

1992 National Certification Program — 1 & 2 Family Housing

1993 National Certification Program — Electrical General

1993 National Certification Program — Commercial

1993 Business Industry Training Institute, Northwest Iowa Community College — 1993 Florida Boards of Building Codes and Standards Certified

1996 NFPA Board Certified into the Electrical Section

1996 Teacher with Pinellas County Vocation Tech School

1996 National Certified as A Board Electrical Contractor

2008 — Florida Certified Electrical Contractor AC# 2712320

2008 — PCCLB License #I-EC 13002856

Education

Attended Florida Beacon College

Bachelor Degree from Rhodes College

MBA from Florida Metropolitan University

Attachment #3: Course Materials and Fees

Course Material:

The course is reviewed online and is available to anyone who purchases it 24/7 as long as there is computer and internet access.

All material necessary to complete the course is included by viewing online. Students are not directed to additional material as a requirement for course completion, only as added information for personal interest.

Course Fee:

The fee for this course is \$44.85

Attachment #4: Schedule of Course Dates and Locations

This course is presented in an online format. The course is available at www.RedVector.com 24 hours a day, 7 days a week to anyone with computer and internet access.

SAMPLE

Certificate of Completion

John Doe

VA License #: 123456

has successfully completed the following course

Series B: 2011 NEC Code Changes - Introduction, Chapter 1 & Chapter 2 (RV-10286)

This online course is approved for 3 continuing education hours

XXXXXXXXXX

date of course completion

Course Approval

Course Completion Date



Matthew Casey, PhD, VP of Content

RedVector.com

AIA Registered Provider #J315

FL DBPR Approved Provider #0001771

FBPE Approved Provider #33



Two Urban Centre • 4890 West Kennedy Boulevard Suite 740 • Tampa, FL 33609

Attachment #6: Online/Correspondence Course Information

Security Procedures Utilized:

All students must register with the web site to gain access to their online course(s). The registration process creates a unique user profile and records their personal information including name, address, phone, email, username, password, licenses held, and license number(s). This information is automatically recorded and saved electronically.

We monitor required student participation in the course by logging and tracking the date and time a student enters a course, tracking activity during the course, and recording the date and time they complete the exam with a required passing score. If our learning management system detects 13-minutes of inactivity, a pop-up appears alerting the student that they must verify their presence or the session times out and the course closes.

In addition, at the completion of an exam, before it is graded, students are asked to confirm an affidavit indicating they personally completed the entire course. They must also confirm their identity before their exam is graded. This confirmation is stored in our database for audit purposes.

Once a student completes and passes the course with a grade of 70% or higher, they are given a certificate of completion and the course completion is recorded in their user profile, along with date and time completed.

End of Course Test:

A copy is attached for review.

Online Course Access:

The Board has been set up with a test account to preview courses on the RedVector.com website. To access the courses, please follow the directions below.

1. Log on to the web site at <http://www.RedVector.com>
2. On the top center of the page click the orange "Sign-In" button.
3. In the gray column labeled "Returning Users" enter your username **VAELEC** and your password **vaelec (both are case-sensitive)**. Click the "LOGIN" button.
4. You should arrive at the User Menu. Click on the second box "My Courses".
5. A list of courses will appear. Click on the title of the course you wish to begin and follow the instructions.

Exam: 2011 NEC Code Changes - Introduction, Chapter 1 & Chapter 2 (4 hour)

1. True or False: The intent of the NEC is to serve as a teaching manual for untrained individuals.
 - A. True
 - B. False

2. The familiar term fine print notes (FPN) has been removed throughout the Code and replaced with _____. "Fine print" refers to a type size, rather than clearly portraying its advisory nature.
 - A. Informational Notes
 - B. Footnotes
 - C. Addendums
 - D. Clarifications

3. True or False: Informative annexes are part of the enforceable requirements of the NEC.
 - A. True
 - B. False

4. True or False: Branch Circuit, Appliance is a branch circuit that supplies energy to one or more outlets to which appliances are to be connected and that has permanently connected luminaires that are not a part of an appliance.
 - A. True
 - B. False

5. True or False: Wires in concealed raceways are not considered concealed, because they may become accessible by withdrawing them.
 - A. True
 - B. False

6. Ampacity is the _____ current, in amperes, that a conductor can carry continuously under the conditions of use without exceeding its temperature rating.
 - A. Maximum
 - B. Minimum
 - C. Approximate
 - D. None of the above

7. Interrupting Rating is the highest current at rated voltage that a device is _____ to interrupt under standard test conditions.
 - A. Intended
 - B. Identified
 - C. Expected

D. All of the above

8. According to the 2011 NEC, a Kitchen is an area with a sink and permanent _____ for food preparation and cooking.
- A. Facilities
 - B. Provisions
 - C. Appliances
 - D. All of the above
9. Service Lateral. This definition applies to:
- A. The underground conductors between the utility electric supply system and the service point.
 - B. The underground conductors between the service point and the first point of connection to the service-entrance conductors in a terminal box, meter, or other enclosure, inside or outside the building wall.
 - C. The overhead conductors between the service point and the first point of connection to the service-entrance conductors at the building or other structure.
 - D. All of the above
10. The NEC now specifies that all working spaces about service equipment, switchboards, panelboards, or motor control centers installed indoors shall be illuminated with:
- A. Only an automatic sensor switch
 - B. Only with a manual switch
 - C. Automatic circuits, but must also be controlled by a circuit which can operate in a manual mode
 - D. None of the above
11. According to 110.31(A)(1) Enclosure for Electrical Installations - Walls and Roof, the walls and roof shall be constructed of materials that have adequate structural strength for the conditions, with a minimum fire rating of _____.
- A. 1 hour
 - B. 2 hours
 - C. 3 hours
 - D. 6 hours
12. According to 110.31(A)(3) Doors, each doorway leading into a vault from the building interior shall be provided with a tight-fitting door that has a minimum fire rating of 3 hours. Where the vault is protected with automatic sprinkler, water spray, carbon dioxide, or halon, construction with a _____ rating shall be permitted.
- A. 1-hour
 - B. 2-hours
 - C. 3-hours
 - D. 4-hours
13. According to 110.31(A)(4) Locks, doors shall be equipped with locks, and doors shall be kept

locked, with access allowed only to _____.

- A. Supervising personnel
- B. Electricians
- C. Qualified persons
- D. All of the above

14. A typical 3-hour construction is _____ thick reinforced concrete.

- A. 3-inch
- B. 6-inch
- C. 4-inch
- D. None of the above

15. Chapter 2 of the NEC is primarily concerned with:

- A. Installing Wiring to Code
- B. Correctly sizing and protecting circuits
- C. Correctly installing the conductors that make up those circuits
- D. All of the above

16. Article 200 provides requirements for the following:

- A. Identification of terminals
- B. Grounded conductors in premises wiring systems
- C. Identification of grounded conductors
- D. All of the above

17. Neutral conductors shall not be used _____, unless specifically permitted elsewhere in this Code.

- A. for more than one branch circuit
- B. for more than one multiwire branch circuit
- C. for more than one set of ungrounded feeder conductors
- D. All of the above

18. Under 200.6 - Means of Identifying Grounded Conductors, Sizes 6 AWG or Smaller. An insulated grounded conductor of 6 AWG or smaller shall be identified by:

- A. By a continuous white outer finish
- B. By a continuous gray outer finish
- C. By three continuous white stripes along its entire length on other than green insulation
- D. All of the above

19. An insulated grounded conductor 4 AWG or larger shall be identified by one of the following means:

- A. A continuous black outer finish.
- B. A continuous gray outer finish
- C. Three continuous black stripes along its entire length on other than green insulation.
- D. None of the above

20. True or False: The NEC re-identified that switch loops can be used for the supply to the switch and as a return conductor from the switch to the outlet.
- A. True
 - B. False
21. According to 210.5(C) (2) Identification of Ungrounded Conductors—Means of Identification, the means of identification shall be permitted to be by:
- A. Separate color coding
 - B. Marking tape
 - C. Tagging
 - D. All of the above
22. True or False: Where two or more branch circuits supply devices or equipment on the same yoke, a means to simultaneously disconnect the ungrounded conductors supplying those devices shall be provided at the point at which the branch circuits originate.
- A. True
 - B. False
23. With the exception that receptacles that are not readily accessible and are supplied by a branch circuit dedicated to electric snow-melting, deicing, or pipeline and vessel heating equipment shall be permitted to be installed in accordance with 426.28 or 427.22, as applicable, Sections 210.8(A) for dwelling units, and 210.8(B) for non-dwelling units will now require that GFCI receptacles be installed: _____.
- A. Behind refrigerators
 - B. In a closet
 - C. In a readily accessible location
 - D. In a fuse panel
24. According to 210.8(A)(7) Sinks, a GFCI is now required for all 125-volt, single-phase, 15- and 20- ampere receptacles installed within _____ of the outside edge of a dwelling unit sink (not just laundry, utility, or wet bar sinks).
- A. 2 feet
 - B. 3 feet
 - C. 4 feet
 - D. 6 feet
25. True or False: In 210.8(B)(7) Locker rooms with associated showering facilities, receptacles installed in locker rooms now require GFCI protection.
- A. True
 - B. False
26. According to 210.19(A)(2), conductors of branch circuits supplying more than one receptacle for cord-and-plug-connected portable loads shall have an ampacity _____ the rating of the branch circuit.

- A. Equal to
- B. Of not less than
- C. Greater than
- D. All of the above

27. 210.52 (C) (3) Peninsular Countertop Spaces. At least one receptacle outlet shall be installed at each peninsular countertop space with a long dimension of _____ and a short dimension of _____.

- A. 24 in. or greater — 12 in. or greater
- B. 12 in or greater — 6 in or greater
- C. 6 in. or greater — 3 in or greater
- D. None of the above

28. True or False: According to 210.52 (C) (5), listed receptacle outlet assemblies are now permitted to be installed on or in the kitchen and bathroom countertops to serve as the required countertop receptacles.

- A. True
- B. False

29. According to 210.52(D) Bathrooms, the receptacle outlet shall be located on a wall or partition that is adjacent to the basin or basin countertop, located on the countertop, or installed on the side or face of the basin cabinet not more than _____ below the countertop. Receptacle outlet assemblies listed for the application shall be permitted to be installed in the countertop.

- A. 3 feet
- B. 12 inches
- C. 1 foot
- D. 2 feet

30. Under 210.52(E)(3) Balconies, Decks, and Porches, balconies, decks, and porches that are accessible from inside the dwelling unit shall have at least one receptacle outlet installed within the perimeter of the balcony, deck, or porch. The receptacle shall not be located more than _____ above the balcony, deck, or porch surface.

- A. 3 feet
- B. 4 feet
- C. 6 feet
- D. 6 ½ feet

31. According to 210.52(G)(1), at least ___ receptacle outlet(s), in addition to those for specific equipment, shall be installed in each basement, in each attached garage, and in each detached garage or accessory building with electric power.

- A. One
- B. Two
- C. Three
- D. Four

32. True or False: According to 220.5(B) Fractions of an Ampere, calculations are not permitted to be rounded to the nearest whole ampere.
- A. True
 - B. False
33. Under 220.18(B) Inductive and LED Lighting Loads, for circuits supplying lighting units that have ballasts, transformers, autotransformers, or LED drivers, the calculated load shall be based on _____.
- A. the total ampere ratings of such units
 - B. the total watts of the lamps
 - C. the minimum ampere ratings of such units
 - D. All of the above
34. 225.30 Number of Supplies. Where a branch circuit or feeder originates in a property, under single management with additional buildings or other structures, only _____ feeder(s) or branch circuit shall be permitted to supply power back to the original building or structure, unless permitted in 225.30(A) through (E).
- A. one
 - B. two
 - C. three
 - D. four
35. According to 230.24(A) Exception No. 5, where the voltage between conductors does not exceed 300 and the roof area is guarded or isolated, a reduction in clearance to _____ shall be permitted.
- A. One foot
 - B. Two feet
 - C. Three feet
 - D. None of the above
36. True or False: The NEC added a new exception 220.43(B) permitting calculation of track lighting load to be based on rating of a device limiting current to the track.
- A. True
 - B. False
37. True or False: The NEC added a new 225.52(B) exception requiring simultaneous disconnection of ungrounded conductors where fused cutouts are used as disconnecting means.
- A. True
 - B. False
38. With 230.24(A) Exception No. 5, the NEC added a new condition for reduced overhead clearance where the roof area is guarded or isolated and the voltage between conductors is 300 volts or less. Service conductors are generally required to have a vertical clearance of not less than 2.5 m (8 ft) above the roof surface. A reduction of clearance for overhead service conductors above a roof of _____ is permitted where the roof area is guarded or isolated.

- A. 6 feet
- B. 4 feet
- C. 3 feet
- D. None of the above

39. The NEC added a new exception 230.42 permitting grounded conductors to be sized at _____ of the continuous and noncontinuous load.
- A. 70%
 - B. 80%
 - C. 90%
 - D. 100%
40. Under 230.54(B) Service-Entrance Cables Equipped with Service Head or Gooseneck, the NEC states that service-entrance cables shall be equipped with a service head listed for use in wet locations. The Exception states that Type SE cable _____.
- A. Need not comply
 - B. Shall be permitted to be formed in a gooseneck and taped with a self-sealing weather-resistant thermoplastic
 - C. Cannot be used
 - D. None of the above
41. According to 230.92 Locked Service Overcurrent Devices, where the service overcurrent devices are locked or sealed or are not readily accessible to the occupant, branch-circuit or feeder overcurrent devices shall be _____.
- A. Installed on the load side
 - B. Mounted in a readily accessible location
 - C. Of lower ampere rating than the service overcurrent device
 - D. All of the above
42. True or False: 240.4(B) Overcurrent Devices Rated 800 Amperes or Less (1) specifies that that "rounding up" to the next standard size overcurrent protective device conductors being protected are part of a branch circuit supplying more than one receptacle for cord-and-plug-connected portable loads.
- A. True
 - B. False
43. True or False: 240.15(B)(2) Grounded Single-Phase Alternating-Current Circuits was revised for correlation with ac voltages specified in UL 489. It specifies that, in grounded systems, individual single-pole circuit breakers rated 120/240 volts ac, with identified handle ties, shall be permitted as the protection for each ungrounded conductor for line-to-line connected loads for single-phase circuits.
- A. True
 - B. False
44. 240.87 Noninstantaneous Trip. Where a circuit breaker is utilized without an instantaneous trip,

one of the following or approved equivalent means shall be provided:

- A. Zone-selective interlocking
- B. Differential relaying
- C. Energy-reducing maintenance switching with local status indicator
- D. All of the above

45. 240.91(B) Devices Rated Over 800 Amperes: For supervised industrial installations the NEC now permits "rounding up" applications in circuits protected by overcurrent protective devices rated more than 800 amperes. Where the overcurrent device is rated over 800 amperes, the ampacity of the conductors it protects shall be equal to or greater than _____ of the rating of the overcurrent device specified in 240.6 in accordance with (B)(1) and (2).

- A. 80%
- B. 85%
- C. 90%
- D. 95%

46. Under 250.8 Connection of Grounding and Bonding Equipment. B) Methods Not Permitted, equipment grounding conductors, grounding electrode conductors, and bonding jumpers shall NOT be connected by:

- A. Terminal bars
- B. Connection devices or fittings that depend solely on solder
- C. Pressure connectors listed as grounding and bonding equipment
- D. Machine screw-type fasteners that engage not less than two threads or are secured with a nut

47. 250.24(C) Grounded Conductor Brought to Service Equipment. (3) Delta-Connected Service states: The grounded conductor of a 3-phase, 3-wire delta service shall have an ampacity _____ of the ungrounded conductors.

- A. 95%
- B. 110%
- C. Not less than that
- D. None of the above

48. 250.30(A)(2) Supply-Side Bonding Jumper: This was revised to require installation of supply-side bonding jumper between the source enclosure and an enclosure containing the first system disconnecting means or overcurrent protective device, and to clarify that the supply-side bonding jumper can be:

- A. Nonflexible metal raceway
- B. A wire
- C. A bus
- D. All of the above

49. Under 250.53(A)(3) Supplemental Electrode, the NEC added a new requirement to provide spacing requirement specific to supplemental electrodes. If multiple rod, pipe, or plate electrodes are installed to meet the requirements of this section, they shall not be less than _____ apart.

- A. 6 feet

- B. 5 feet
- C. 4 feet
- D. 3 feet

50. A Separately Derived System has no direct connection from circuit conductors of one system to circuit conductors of another system, other than connections through the earth and ____.
- A. Metal enclosures
 - B. Metallic raceways
 - C. Equipment grounding conductors
 - D. All of the above

Attachment #1: Course Syllabus

Course Title:

2014 NEC Changes - Introduction, Chapter 1 & Chapter 2 (RV-PGM101)

Course Hours:

3 hours

Course Instructor:

Neal Burdick

Course Description:

The National Electrical Code® (NEC®) is the United States standard for the safe installation of electrical wiring and equipment. Since 1911 the NFPA® has been making updates to the NEC Code document. The NEC is updated and published every 3 years. This course provides coverage of significant changes in the 2014 National Electrical Code® Chapters 1& 2. With every new edition of the NEC, some of the changes include new requirements to sections, while some of the changes include entirely new articles. Some changes are revisions to existing requirements while others are deletions to some existing requirements.

NOTE: This course is formatted in 2 lessons with the exam given at the end of each lesson. Each lesson must be passed with a score of 70% or higher before being allowed to proceed to the next lesson. The lessons are listed below:

Lesson 1: 2014 NEC Changes - Articles 90, 100, and 110 (Introduction and Chapter 1)

Lesson 2: 2014 NEC Changes - Chapter 2: Wiring and Protection

Course Objectives:

By the end of this course, you will be able to:

- Differentiate between previously used and newly adopted terminology.
- Identify the power sources that comprise a hybrid system.
- Name who is responsible for affixing the arc-flash warning label for electrical equipment that will ensure the safety of the public.
- Recognize the appropriate place to install GFCI protection to protect the public's safety
- List the areas in which the AFCI requirements have expanded
- Breakdown the requirements of dwelling unit receptacle outlets to provide a safe environment for the public
- Identify the conditions that must be met in order to calculate lighting load under the energy code
- Provide the limitations the NEC® has instituted on the size of breakers.

Lesson 1 Outline:

INTRODUCTION

- Code-Wide Changes
- Other Changes

ARTICLE 90— Introduction

- 90.1 Purpose
- 90.2 Scope
- 90.3 Code Arrangement

- 90.8 Wiring Planning

CHAPTER 1 — General

ARTICLE 100 — Definitions

ARTICLE 110 — Requirements for Electrical Installations:

Part I General

- Introduction
- General
- 110.1 Scope
- 110.9 Interrupting Rating
- 110.12 Mechanical Execution of Work
- 110.14 Electrical Connections
- 110.16 Arc-Flash Hazard Warning
- 110.21 Marking
- 110.22 Identification of Disconnecting Means
- 110.24 Available Fault Current
- 110.25 Lockable Disconnecting Means

Part II 600 Volts, Nominal, or Less

- 110.26 Spaces About Electrical Equipment
- 110.27 Guarding of Live Parts

Conclusion

Lesson 2 Outline:

Introduction

ARTICLE 200 — Use and Identification of Grounded Conductors

- 200.4 Neutral Conductors
- 200.6 Means of Identifying Grounded Conductors

ARTICLE 210 — Branch Circuits

- 210.5 Identification for Branch Circuits
- 210.8 Ground-Fault Circuit-Interrupter – Protection for Personnel
- 210.12 Arc-Fault Circuit-Interrupter Protection
- 210.13 Ground Fault Protection of Equipment
- 210.17 Electric Vehicle Branch Circuit
- 210.52 Dwelling Unit Receptacle Outlets
- 210.64 Electrical Service Areas

ARTICLE 220 Branch-Circuit, Feeder, and Service Calculations

- 220.3 Application of Other Articles
- 220.12 Lighting Load for Specified Occupancies
- 225.52 Disconnecting Means

ARTICLE 230 — Services

- 230.30 Installation (Underground Service Conductors)
- 230.44 Cable Trays
- 230.82 Equipment Connected to the Supply Side of Service Disconnect

ARTICLE 240 Overcurrent Protection

- 240.21 Location in Circuit
- 240.87 Arc Energy Reduction

ARTICLE 250 Grounding and Bonding

- 250.8 Connection of Grounding and Bonding Equipment
- 250.21 Alternating-Current Systems of 50 Volts to Less Than 1000 Volts Not Required to Be Grounded
- 250.24 Grounding Service Supplied Alternating-Current Systems
- 250.64 Grounding Electrode Conductor Installation
- 250.66 Size of Alternating Current Grounding Electrode Conductor
- 250.68 Grounding Electrode Conductor and Bonding Jumper Connection to Grounding Electrodes
- 250.102 Bonding Conductors and Jumpers
- 250.122 Size of Equipment Grounding Conductors
- 250.130 Equipment Grounding Conductor Connections
- 250.166 Size of the Direct-Current Grounding Electrode Conductor
- 250.167 Direct-Current Ground-Fault Detection
- 250.186 Ground-Fault Circuit Conductor Brought to Service Equipment
- 250.194 Grounding and Bonding of Fences and Other Metal Structures

ARTICLE 285 – Surge-Protective Devices (SPDs), 1000 or Less

- 285.13 Type 4 and Other Component Type SPDs

Conclusion



RECEIVED
SEP 9 2014
CONTRACTORS

2014 NEC Changes - Articles 90, 100, and 110
(Introduction & Chapter 1)

Table of Contents

- Introduction 3
 - Course Overview 3
- Learning Objectives 3
- Code-Wide Changes in the 2014 National Electrical Code..... 4
 - New Articles 4
 - Code-Wide Changes made to Field-Applied Hazard Markings, Lockable Disconnecting Means, Direct current (dc) Circuits, Switchgear 6
- ARTICLE 90..... 8
 - 90.1 Purpose 8
 - 90.2 Scope 9
 - 90.3 Code Arrangement 11
 - 90.8 Wiring Planning 12
- ARTICLE 100..... 13
 - Definitions and Scope..... 13
 - I. General 14
 - II. Over 600 Volts, Nominal 28
- Article 110 — Requirements for Electrical Installations 30
 - Introduction..... 30
 - I. General 31
 - II. 600 Volts, Nominal, or Less 36
- Conclusion 40
 - Summary..... 40
- Resources..... 41
 - References 41
- Author Biography 42
 - Neal L. Burdick 42

Introduction

Course Overview

This is the **first** of several courses covering the changes in the 2014 edition of the **National Electrical Code** (NEC) created by the NFPA.

This Course provides coverage of significant changes in the *2014 National Electrical Code*. With every new edition of the NEC, some of the changes include new requirements to sections, while some of the changes include entirely new articles. Some changes are revisions to existing requirements while others are deletions to some existing requirements.

Although not required, **it is recommended to have a copy of the 2014 NEC manual for reference**, especially when reviewing information in large tables.

A **Summary of each change** is followed by the actual NEC Language, with deletions showing with a ~~strikethrough~~ and additions/changes (highlighted in yellow). When necessary, **Comments** are added to appropriate topics.

In many cases, paragraphs not directly affected by a change are retained to preserve context. *There will be no quiz questions on material that does not cover changes in the 2014 NEC.*

The length of each segment varies depending on the topic and material available.

A final quiz at the end of the course helps demonstrate your understanding of the material.

The National Electrical Code is intended for electricians and subcontractors, electrical inspectors, electrical engineers, designers, and other qualified persons who understand electrical currents, theory, safety procedures, and electrical trade practices. The code does not serve as a teaching manual for untrained individuals.

Learning Objectives

At the end of this course, you will be able to:

- Select the newly added articles that address the safe installation of electrical equipment.
- Summarize product standards and installation requirements to facilitate safe installation.
- Label items that are readily accessible to protect from dangerous situations.
- Differentiate between previously used and newly adopted terminology.
- Identify the power sources that comprise a hybrid system.
- Recall what is included in premises wiring.
- Name who is responsible for affixing the arc-flash warning label for electrical equipment that will ensure the safety of the public.

Code-Wide Changes in the 2014 National Electrical Code

New Articles

The following summary of the 2014 Code Changes was written by Keith Lofland, IAEI Magazine.

Article 393 - Low-Voltage Suspended Ceiling Power Distribution Systems

The NEC now addresses low-voltage Class 2 ac and dc volt equipment connected to ceiling grids, and walls built specifically for this type of power distribution system. Also, we now have better language supporting the practical safeguarding of circuits and electrical equipment operating at 30 volts ac, or 60 volts dc, or less.

The 2014 NEC improved coverage of alternative energy sources such as photovoltaics, wind turbines, batteries, fuel cells, etc.) and the spread of low-voltage, low-power devices such as sensors, LV lighting, IT equipment, AV equipment, etc.

Article 393 now addresses equipment with similar characteristics to track lighting, including the wiring and power supply requirements. It also covers specific requirements for the safe installation of low-voltage, power-limited power distribution providing power to lighting and non-lighting loads.

Article 646 Modular Data Centers

This new article in Chapter 6 addresses data centers that currently fall under the scope of *Article 645, Information Technology Equipment. Modular Data Centers (MDCs)* that are an important emerging trend in data center architecture. Their construction, installation and use result in a unique hybrid piece of equipment that falls somewhere in-between a large enclosure and a prefabricated building. The contained equipment in the enclosures or prefabricated buildings generally are fully customizable and scalable to provide data center operations but, typically, would not be permanently installed.

Article 645 is applicable only to installations that meet the criteria of 645.4. Otherwise, Article 645 would not be applicable to these products and the other articles of the *Code* would have to be applied. However, it is not always obvious which requirements of the *NEC* are applicable, or how they should be applied given the complexity, customization and scalability of modular data centers.

This article pinpoints those areas of the *NEC* that should be applied to MDCs and also includes additional new requirements where necessary.

Article 728 Fire-Resistive Cable Systems

The NEC added a new article to address installations of fire-resistive cables, critical to function during a fire. These cable systems must be installed with very specific materials, supports, and requirements and are critical for the survivability of life safety circuits. Details for installing fire-rated cables differ from other type cables.

Some of these variances pertain to conduit, conduit supports, type of couplings, vertical supports and boxes and splices.

Article 750 Energy Management Systems

This new article provides some general requirements to address the types of loads permitted to be controlled through energy management.

Energy management has become common in electrical infrastructure through the control of utilization equipment, energy storage and power production. Installation codes currently establish requirements for utilization equipment, for energy storage, and for power production *that serve to address facility and personnel safety.*

However, in installation codes, there has been limited consideration to actively managing these systems to reduce energy cost or to support peak power needs for the demands of a much broader electrical infrastructure.

This article includes definitions, requirements for alternative power sources, load-management provisions and field-marking requirements.

Code-Wide Changes made to Field-Applied Hazard Markings, Lockable Disconnecting Means, Direct current (dc) Circuits, Switchgear

Field-Applied Hazard Markings

A new 110.21(B) lists specific requirements for warning labels and similar markings where required or specified elsewhere in the *Code*. The *NEC* contains several requirements for labels on wiring methods and equipment. These required labels or markings typically include one of the following hazard commands:

DANGER, WARNING, or CAUTION

These markings, signs or labels should meet ANSI Z535.4 for suitable font sizes, words, colors, symbols and location requirements.

Lockable Disconnecting Means in Article 110

The new 110.25 provides consistent requirements for a lockable disconnecting means.

Requirements for Direct current (*dc Systems*) are now integrated throughout the *NEC*.

Direct current (dc) applications are evolving due to electric vehicle charging, solar photovoltaic (PV) systems, microgrids, wind generated electric systems, etc.

In many cases, these dc systems can attain greater efficiencies and energy savings than their conventional alternating current (ac) contemporaries. Installers of these different dc applications have been known to use inconsistent polarity identification schemes, particularly with regard to whether or not the grounded conductors of negatively-grounded or positively-grounded two-wire dc systems are actually identified as such.

Such inconsistency can cause risk and confusion for installers and service personnel where the branch circuits of these various applications and branch circuits of conventional ac circuits come together. These inconsistencies necessitate consistent and reliable rules throughout the *NEC* for these dc systems.

Use of the Term *Switchgear* Incorporated throughout the *NEC*

The term *switchgear* includes all types of switchgear such as *metal-enclosed low-voltage power circuit breaker switchgear*, *metal-clad switchgear*, and *metal-enclosed interrupter switchgear*.

The existing definition for *metal-enclosed power switchgear* was modified and retitled to simply *switchgear* to make it inclusive of all types of switchgear.

This revised definition makes it possible to utilize this generic term in all locations where the term *switchboard* is already mentioned, and where the use of the term *switchgear* is appropriate.

Definitions Relocated to Article 100

Several definitions previously in various articles have been relocated to Article 100 because these terms are also found in other articles, not just in the article where the previous definition was located. An example of this would be the definition of *effective ground-fault current path* relocated from 250.2 to Article 100. The *NEC Style Manual* at section 2.2.2.1 generally requires that Article 100 contain definitions of terms that appear in two or more other articles of the *NEC*.

Changes throughout the *NEC* from the 600 volts threshold to 1000 volts.

Voltage threshold has been moved from 600 volts to 1000 volts in several locations throughout the *NEC*.

Solar photovoltaic (PV) systems are currently being installed at dc voltages over 600 volts up to and including 1000 volts, 1200 volts, 1500 volts, and 2000 volts dc, making it necessary to provide product standards and installation requirements to facilitate their safe installation.

Moving the *NEC* threshold from 600 volts to 1000 volts will not, by itself, allow the immediate installation of systems at 1000 volts. Equipment must first be tested and found acceptable for use at the higher voltage(s). Nor will the testing and listing of equipment, by itself, allow for the installation of 1000-volt systems. The *NEC* must include prescriptive requirements to permit the installation of systems that operate over 600 but less than or equal to 1000 volts.

This is just the first step of many to recognize emerging technology with prescriptive requirements to ensure that these systems and products can be safely installed and inspected in accordance with the *NEC*.

ARTICLE 90

90.1 Purpose

The NEC deleted the previous "Intention" of the *Code* and changed into the "Purpose" of the *Code*.

NEC Language

(A) Practical Safeguarding Purpose

The **purpose** of this Code is the practical safeguarding of persons and property from hazards arising from the use of electricity. This Code is not intended as a design specification or an instruction manual for untrained persons.

(B) Adequacy

This Code contains provisions that are considered necessary for safety. Compliance therewith and proper maintenance results in an installation that is essentially free from hazard but not necessarily efficient, convenient, or adequate for good service or future expansion of electrical use.

Informational Note: Hazards often occur because of overloading of wiring systems by methods or usage not in conformity with this Code. This occurs because initial wiring did not provide for increases in the use of electricity. An initial adequate installation and reasonable provisions for system changes provide for future increases in the use of electricity.

~~(C) Intention. This Code is not intended as a design specification or an instruction manual for untrained persons.~~

~~(D)~~(C) Relation to Other International Standards.

The requirements in this Code address the fundamental principles of protection for safety contained in Section 131 of International Electrotechnical Commission Standard 60364-1, Electrical Installations of Buildings.

Informational Note: IEC 60364-1, Section 131, contains fundamental principles of protection for safety that encompass protection against electric shock, protection against thermal effects, protection against overcurrent, protection against fault currents, and protection against overvoltage.

All of these potential hazards are addressed by the requirements in this *Code*.

Comments

The previous language at 90.1(C) was a negative statement that told users of the Code what the NEC was *not intended for*. Combining the intent and the purpose of the Code into one subsection, provides a positive statement about the intention of the NEC.

90.2 Scope

NEC Language

The 2011 NEC (Code) covers:

- The installation of electrical conductors, equipment, and raceways
- Signaling and communications conductors
- Equipment, and raceways; and
- Optical fiber cables and raceways for the following:
 - (1) Public and private premises, including buildings, structures, mobile homes, recreational vehicles, and floating buildings
 - (2) Yards, lots, parking lots, carnivals, and industrial substations
 - (3) Installations of conductors and equipment that connect to the supply of electricity
 - (4) Installations used by the electric utility, such as office buildings, warehouses, garages, machine shops, and recreational buildings, that are not an integral part of a generating plant, substation, or control center.
- The Code does not cover the following:
 - (1) Installations in ships, watercraft other than floating buildings, railway rolling stock, aircraft, or automotive vehicles other than mobile homes and recreational vehicles
 - Informational Note:** Although the scope of this Code indicates that the Code does not cover installations in ships, portions of this Code are incorporated by reference into Title 46, Code of Federal Regulations, Parts 110–113.
 - (2) Installations underground in mines and self-propelled mobile surface mining machinery and its attendant electrical trailing cable
 - (3) Installations of railways for generation, transformation, transmission, or distribution of power used exclusively for operation of rolling stock or installations used exclusively for signaling and communications purposes
 - (4) Installations of communications equipment under the exclusive control of communications utilities located outdoors or in building spaces used exclusively for such installations
 - (5) Installations under the exclusive control of an electric utility where such installations
 - a. Consist of service drops or service laterals, and associated metering; or
 - b. Are on property owned or leased by the electric utility for the purpose of communications, metering, generation, control, transformation, transmission, or distribution of electric energy, or

- c. Are located in legally established easements or rights-of-way, or
- d. Are located by other written agreements either designated by or recognized by public service commissions, utility commissions, or other regulatory agencies having jurisdiction for such installations. These written agreements shall be limited to installations for the purpose of communications, metering, generation, control, transformation, transmission, or distribution of electric energy where legally established easements or rights-of-way cannot be obtained. These installations shall be limited to federal lands, native American reservations through the U.S. Department of the Interior Bureau of Indian Affairs, military bases, lands controlled by port authorities and state agencies and departments, and lands owned by railroads.

Informational Note to (4) and (5): Examples of utilities may include those entities that are typically designated or recognized by governmental law or regulation by public service/utility commissions and that install, operate, and maintain electric supply (such as generation, transmission, or distribution systems) or communications systems (such as telephone, CATV, Internet, satellite, or data services). Utilities may be subject to compliance with codes and standards covering their regulated activities as adopted under governmental law or regulation. Additional information can be found through consultation with the appropriate governmental bodies, such as state regulatory commissions, the Federal Energy Regulatory Commission, and the Federal Communications Commission.

(C) Special Permission

The NEC added "at a readily accessible location".

NEC Language

90.2 (C) Special Permission

The authority having jurisdiction for enforcing this *Code* may grant exception for the installation of conductors and equipment that are not under the exclusive control of the electric utilities and are used to connect the electric utility supply system to the service conductors of the premises served, provided such installations are outside a building or structure, or terminate inside at a readily accessible location nearest the point of entrance of the service conductors.

90.3 Code Arrangement

NEC Language

The NEC is divided into the introduction and nine chapters, as shown in Figure 90.3 in the NEC Manual:

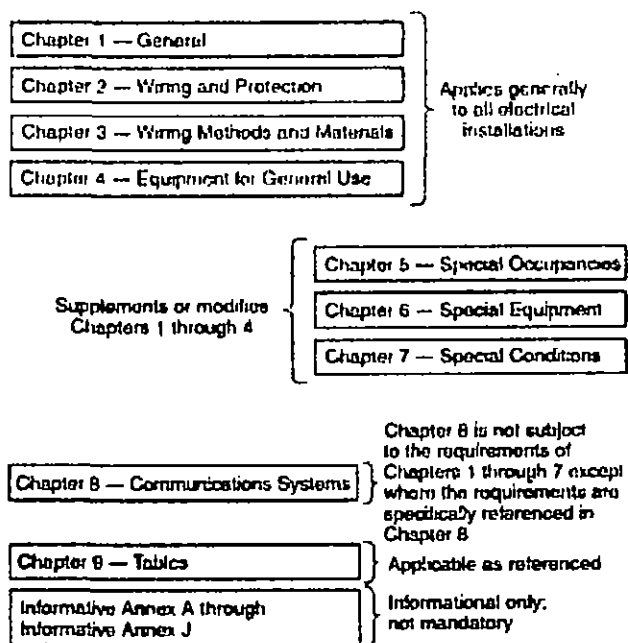

Source: NEC 2014

Figure 90.3 Code Arrangement

Chapters 1, 2, 3, and 4 apply generally

Chapters 5, 6, and 7 apply to special occupancies, special equipment, or other special conditions. These latter chapters supplement or modify the general rules.

Chapters 1 through 4 apply except as amended by Chapters 5, 6, and 7 for the particular conditions.

Chapter 8 covers communications systems and is not subject to the requirements of Chapters 1 through 7 except where the requirements are specifically referenced in Chapter 8.

Chapter 9 consists of tables that are applicable as referenced.

90.8 Wiring Planning

(B) Number of Circuits in Enclosures

The previous language in 90.8(B) indicated that a short-circuit or ground-fault condition was limited to any one circuit within raceways or enclosures.

The NEC deleted the words "in one circuit" in the last sentence to clarify that a short-circuit or ground-fault condition is not limited to any one circuit within raceways or enclosures.

NEC Language

90.8 (B) Number of Circuits in Enclosures. It is elsewhere provided in this Code that the number of wires and circuits confined in a single enclosure be varyingly restricted. Limiting the number of circuits in a single enclosure minimizes the effects from a short circuit or ground fault ~~in one circuit.~~

Comments

In NEC 2011, 90.8(B) was misleading because it indicated that a short-circuit or ground-fault condition was limited to just one circuit within a raceway or enclosure.

The removal of the phrase "in one circuit" makes it clear that a short-circuit or ground-fault condition is not limited to any one circuit within raceways or enclosures.

ARTICLE 100

Definitions and Scope

This NEC article ***contains only those definitions essential to the proper application of this Code.*** It is not intended to include commonly defined general terms or commonly defined technical terms from related codes and standards.

In general, in Article 100, the NEC defines only those terms used in two or more articles.

Other definitions are included in the article in which they are used but may be referenced in Article 100.

Part I of this article contains definitions intended to apply wherever the terms are used throughout this Code.

Part II contains definitions applicable only to articles and parts of articles specifically covering installations and equipment operating at over 600 volts, nominal.

I. General

Changed From NEC 2011

Accessible, Readily (Readily Accessible)

The revision of this definition now prohibits "the use of tools" when equipment is required to be readily accessible.

NEC Language

Accessible, Readily (Readily Accessible). Capable of being reached quickly for operation, renewal, or inspections without requiring those to whom ready access is requisite to actions such as to use tools, to climb over or remove obstacles, or to resort to portable ladders, and so forth.

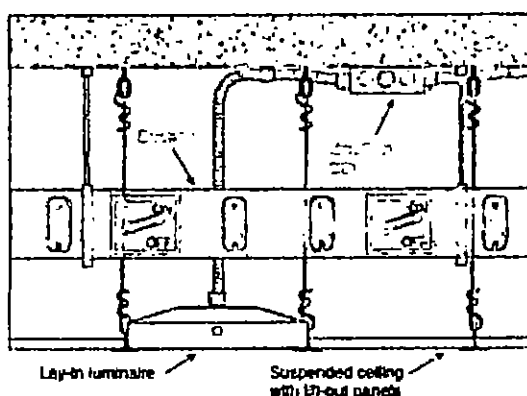

Source: HIS/NFPA

Examples of busways and junction boxes considered to be readily accessible even if located behind hung ceilings having lift out panels

Comments

The previous definition of *readily accessible* prohibited persons from having to climb over or remove obstacles or resort to the use of portable ladders, etc., in order to gain access to *readily accessible* equipment.

The NEC now prohibits having to resort to the use of tools in order to gain access to *readily accessible* equipment.

The *NEC* clearly distinguishes between electrical equipment required to be *accessible* and equipment required to be *readily accessible*.

For equipment to be *readily accessible*, a person should be able to walk right up to it and gain access without having to climb a ladder, remove a ceiling tile, crawl through an attic, etc.

Using a tool to reach a piece of equipment for operation, renewal, or inspection may make it *accessible*, but not necessarily *readily accessible*. The need to use a tool, even one as simple as a screw driver, would add another level of action that would impede or delay this ready access.

Adjustable Speed Drive

The NEC revised the definitions of *adjustable speed drive* and *adjustable speed drive system* and relocated them from 430.2 to Article 100.

NEC Language

Adjustable Speed Drive. Power conversion equipment that provides a means of adjusting the speed of an electric motor.

Informational Note: A variable frequency drive is one type of electronic adjustable speed drive that controls the rotational speed of an ac electric motor by controlling the frequency and voltage of the electrical power supplied to the motor.

Adjustable Speed Drive System. A combination of an adjustable speed drive, its associated motor(s), and auxiliary equipment.

Comments

Electronic control and protection of motor compressors is becoming more common, while the use of traditional electromechanical control and protection of motor-compressors is becoming less desirable.

Askarel

The 2014 NEC added an *Informational Note* to the definition of **Askarel**.

NEC Language

Askarel. A generic term for a group of nonflammable synthetic chlorinated hydrocarbons used as electrical insulating media. Askarels of various compositional types are used. Under arcing conditions, the gases produced, while consisting predominantly of noncombustible hydrogen chloride, can include varying amounts of combustible gases, depending on the askarel type.

Informational Note: Askarels of various compositional types are used. Under arcing conditions, the gases produced, while consisting predominantly of noncombustible hydrogen chloride, can include varying amounts of combustible gases, depending on the askarel type.

Battery System

The NEC added a definition of *Battery System*.

NEC Language

Battery System. Interconnected battery subsystems consisting of one or more storage batteries and battery chargers, and can include inverters, converters, and associated electrical equipment.

Cable Routing Assembly

The NEC added a definition of *Cable Routing Assembly*.

NEC Language

Cable Routing Assembly. A single channel or connected multiple channels, as well as associated fittings, forming a structural system that is used to support and route

Changes in the 2014 National Electrical Code (NEC®): Articles 90, 100, and 110

communications wires and cables, optical fiber cables, data cables associated with information technology and communications equipment, Class 2 and Class 3 cables, and power limited fire alarm cables.

Charge Controller

The NEC added a definition of *Charge Controller*.

NEC Language

Charge Controller. Equipment that controls dc voltage or dc current, or both, and that is used to charge a battery or other energy storage device.

Communications Equipment

The NEC modified the definition of *Communications Equipment*.

NEC Language

Communications Equipment. The electronic equipment that performs the telecommunications operations for the transmission of audio, video, and data, and includes power equipment (e.g., dc converters, inverters, and batteries), technical support equipment (e.g., computers), and conductors dedicated solely to the operation of the equipment.

Communications Raceway

The NEC added a definition of *Communications Raceway*.

NEC Language

Communications Raceway. An enclosed channel of nonmetallic materials designed expressly for holding communications wires and cables, typically communications wires and cables and optical fiber and data (Class 2 and Class 3) in plenum, riser, and general-purpose applications.

Concealed

The NEC added an *Informational Note* to the definition of *Concealed*.

NEC Language

Concealed. Rendered inaccessible by the structure or finish of the building. Wires in concealed raceways are considered concealed, even though they may become accessible by withdrawing them.

Informational Note: Wires in concealed raceways are considered concealed, even though they may become accessible by withdrawing them.

Control Circuit

The NEC revised and relocated the definitions of *motor control circuit* and *control circuit*.

NEC Language

Control Circuit. The circuit of a control apparatus or system that carries the electric signals directing the performance of the controller but does not carry the main power current.

Comments

The terms *motor control circuit* and *control circuit* were defined in three different articles of the Code.

409.2 Definitions: Control Circuit. The circuit of a control apparatus or system that carries the electric signals directing the performance of the controller but does not carry the main power current.

430.2 Definitions: Motor Control Circuit. The circuit of a control apparatus or system that carries the electric signals directing the performance of the controller but does not carry the main power current.

522.2 Definitions: Control Circuit. For the purposes of this article, the circuit of a control system that carries the electrical signals directing the performance of the controller but does not carry the main power current.

The 2014 NEC revised the definition of *motor control circuit* by removing the word “motor,” making the term *control circuit*, which is now a new definition in Article 100 that applies to all control circuits, not just motor control circuits.

The 2014 NEC also removed the previous definitions in Article 409, *Industrial Control Panels*; Article 430, *Motors, Motor Circuits, and Controllers*; and Article 522, *Control Systems for Permanent Amusement Attractions*.

Coordination (Selective)

The definition of *selective coordination* was revised to improve clarity and readability.

NEC Language

Coordination (Selective). Localization of an overcurrent condition to restrict outages to the circuit or equipment affected, accomplished by the selection and installation of overcurrent protective devices and their ratings or settings for the full range of available overcurrents, from overload to the maximum available fault current, and for the full range of overcurrent protective device opening times associated with those overcurrents.

Comments

The previous definition for *selective coordination* implied that selective coordination was a choice. In fact, it is not a choice that provides for a selectively coordinated system; rather, it's the “selection and installation” of the same.

In the first part of the definition, the word “choice” was replaced with “*selection and installation*”.

Additional language indicates that *selective coordination* is for the full range of overcurrents that the overcurrent protective devices could experience and for whatever opening times it takes for the overcurrent protective devices to open at those overcurrent levels.

Copper-Clad Aluminum Conductors

The NEC added a definition of *Copper-Clad Aluminum Conductors*.

NEC Language

Copper-Clad Aluminum Conductors. Conductors drawn from a copper-clad aluminum rod, with the copper metallurgically bonded to an aluminum core, where the copper forms a minimum of 10 percent of the cross-sectional area of a solid conductor or each strand of a stranded conductor.

Device

The NEC revised the definition of **device** to indicate that a device is not a conductor.

NEC Language

Device. A unit of an electrical system, other than a conductor, that carries or controls electric energy as its principal function.

Comments

The previous definition could be interpreted that a conductor is a device, as a conductor "carries or controls electric energy as its principal function."

The 2014 NEC inserted the phrase "other than a conductor" into the definition, thus clearly distinguishing a device and a conductor.

Effective Ground-Fault Current Path

The NEC revised and relocated the definition for *effective ground-fault current path* from 250.2 to Article 100.

NEC Language

Effective Ground-Fault Current Path. An intentionally constructed, low-impedance electrically conductive path designed and intended to carry current under ground-fault conditions from the point of a ground fault on a wiring system to the electrical supply source and that facilitates the operation of the overcurrent protective device or ground-fault detectors ~~on high-impedance grounded systems.~~

Comments

The definition of *effective ground-fault current path* was located at 250.2 and indicated that an effective fault-current path facilitates ground-fault detector operation only on high-impedance grounded systems.

At the end of the relocated definition, the phrase "on high-impedance grounded systems" was removed since an effective fault current path facilitates ground-fault detector operation on systems other than just high-impedance grounded systems, such as ungrounded systems.

Changes in the 2014 National Electrical Code (NEC®): Articles 90, 100, and 110

An ungrounded system ground-fault detection system is based on magnitude and vector relationship at the source and not on the carrying of current from the location of ground fault to the source.

Electric-Discharge Lighting

The NEC added a definition of *Electric Discharge Lighting*.

NEC Language

Electric-Discharge Lighting. Systems of illumination utilizing fluorescent lamps, high-intensity discharge (HID) lamps, or neon tubing.

Electronically Actuated Fuse

The NEC added a definition of *Electronically Actuated Fuse*.

NEC Language

Electronically Actuated Fuse. An overcurrent protective device that generally consists of a control module that provides current-sensing, electronically derived time–current characteristics, energy to initiate tripping, and an interrupting module that interrupts current when an overcurrent occurs.

Such fuses may or may not operate in a current-limiting fashion, depending on the type of control selected.

Ground Fault

The NEC added **conductive** to the definition of *Ground Fault*.

NEC Language

Ground Fault. An unintentional, electrically conductive connection between an ungrounded conductor of an electrical circuit and the normally non–current-carrying conductors, metallic enclosures, metallic raceways, metallic equipment, or earth.

Ground-Fault Current Path

The NEC added a *definition* and *Informational Note* of *Ground-Fault Current Path*.

NEC Language

Ground-Fault Current Path. An electrically conductive path from the point of a ground fault on a wiring system through normally non–current-carrying conductors, equipment, or the earth to the electrical supply source.

1. **Informational Note:** Examples of ground-fault current paths are any combination of equipment grounding conductors, metallic raceways, metallic cable sheaths, electrical equipment, and any other electrically conductive material such as metal, water, and gas piping; steel framing members; stucco mesh; metal ducting; reinforcing steel; shields of communications cables; and the earth itself.

Grounding Conductor, Equipment (EGC)

The NEC modified the definition of *Grounding Conductor, Equipment (EGC)*.

NEC Language

Grounding Conductor, Equipment (EGC). The conductive path(s) that provides a ground-fault current path and connects normally non-current-carrying metal parts of equipment together and to the system grounded conductor or to the grounding electrode conductor, or both.

Hermetic Refrigerant Motor-Compressor

The NEC added a definition of *Hermetic Refrigerant Motor-Compressor*.

NEC Language

Hermetic Refrigerant Motor-Compressor. A combination consisting of a compressor and motor, both of which are enclosed in the same housing, with no external shaft or shaft seals, with the motor operating in the refrigerant.

Hybrid System

The NEC corrected and modified the definition of *Hybrid System*.

NEC Language

Hybrid System. A system comprised of multiple power sources. These power sources could include photovoltaic, wind, micro-hydro generators, engine-driven generators, and others, but do not include electric power production and distribution network systems. Energy storage systems such as batteries, flywheels, or superconducting magnetic storage equipment do not constitute a power source for the purpose of this definition. The energy regenerated by an overhauling (descending) elevator does not constitute a power source for the purpose of this definition.

Industrial Control Panel

The NEC added the definition of *Industrial Control Panel*.

NEC Language

Industrial Control Panel. An assembly of two or more components consisting of one of the following: (1) power circuit components only, such as motor controllers, overload relays, fused disconnect switches, and circuit breakers; (2) control circuit components only, such as push buttons, pilot lights, selector switches, timers, switches, and control relays; (3) a combination of power and control circuit components. These components, with associated wiring and terminals, are mounted on, or contained within, an enclosure or mounted on a subpanel.

The industrial control panel does not include the controlled equipment.

Intersystem Bonding Termination

Only intersystem bonding conductors are permitted to terminate on the *intersystem bonding termination*.

NEC Language

Intersystem Bonding Termination. A device that provides a means for connecting intersystem bonding conductors for communications systems to the grounding electrode system.

Comments

The term *bonding conductors* was revised to *intersystem bonding termination* to clarify the type of bonding conductors that are permitted to terminate on the intersystem bonding termination.

The revision to the existing definition of *intersystem bonding termination* makes it clear that other bonding conductors should not be connected to the intersystem bonding termination. The revision provides clarity and correlation with the text of 250.94, *Bonding of Other Systems*.

Not all types of bonding conductors should be connected to the intersystem bonding termination. The intersystem bonding termination is specifically for the connection of intersystem bonding conductors of such "other systems" as communication circuits.

Lighting Track (Track Lighting)

The NEC added a definition of *Lighting Track (Track Lighting)*.

NEC Language

Lighting Track (Track Lighting). A manufactured assembly designed to support and energize luminaires that are capable of being readily repositioned on the track. Its length can be altered by the addition or subtraction of sections of track.

Location, Damp

The NEC added an *Informational Note* to the definition of *Location, Damp*.

NEC Language

Location, Damp. Locations protected from weather and not subject to saturation with water or other liquids but subject to moderate degrees of moisture. Examples of such locations include partially protected locations under canopies, marquees, roofed open porches, and like locations, and interior locations subject to moderate degrees of moisture, such as some basements, some barns, and some cold-storage warehouses.

Informational Note: Examples of such locations include partially protected locations under canopies, marquees, roofed open porches, and like locations, and interior locations subject to moderate degrees of moisture, such as some basements, some barns, and some cold-storage warehouses.

Overcurrent Protective Device, Branch-Circuit

The NEC modified the definition of *Overcurrent Protective Device, Branch-Circuit*.

NEC Language

Overcurrent Protective Device, Branch-Circuit. A device capable of providing protection for service, feeder, and branch circuits and equipment over the full range of overcurrents between its rated current and its interrupting rating. Such devices are provided with interrupting ratings appropriate for the intended use but no less than 5000 amperes.

Premises Wiring (System)

The NEC added a new *Informational Note* to the existing definition to provide examples of premises wiring systems.

NEC Language

Premises Wiring (System). Interior and exterior wiring, including power, lighting, control, and signal circuit wiring together with all their associated hardware, fittings, and wiring devices, both permanently and temporarily installed. This includes (a) wiring from the service point or power source to the outlets or (b) wiring from and including the power source to the outlets where there is no service point.

Such wiring does not include wiring internal to appliances, luminaires, motors, controllers, motor control centers, and similar equipment.

Informational Note: Power sources include, but are not limited to, interconnected or stand-alone batteries, solar photovoltaic systems, other distributed generation systems, or generators.

Comments

The 2011 *NEC* defined *premises wiring (system)* but did not include an *Informational Note* with examples such as batteries, photovoltaic systems, interconnected power sources, and stand-alone generators.

Qualified Person

The *Informational Note* updated the reference to NFPA 70E - 2012..

NEC Language

Qualified Person. One who has skills and knowledge related to the construction and operation of the electrical equipment and installations and has received safety training to recognize and avoid the hazards involved.

Informational Note: Refer to NFPA 70E-2012, *Standard for Electrical Safety in the Workplace*, for electrical safety training requirements.

Raceway

The definition of *raceway* was revised by removing the laundry list of raceways listed in the previous definition.

NEC Language

Raceway. An enclosed channel of metallic or nonmetallic materials designed expressly for holding wires, cables, or busbars, with additional functions as permitted in this *Code*.

Informational Note: A raceway is identified within specific article definitions.

Specific changes made to this paragraph are:

Raceway. An enclosed channel of ~~metal~~ metallic or nonmetallic materials designed expressly for holding wires, cables, or busbars, with additional functions as permitted in this *Code*.

~~Raceways include, but are not limited to, rigid metal conduit, rigid nonmetallic conduit, intermediate metal conduit, liquidtight flexible conduit, flexible metallic tubing, flexible metal conduit, electrical nonmetallic tubing, electrical metallic tubing, underfloor raceways, cellular~~

~~concrete floor raceways, cellular metal floor raceways, surface raceways, wireways, and busways.~~

Comments

The previous definition of *raceway* included a list of wiring methods that are considered raceways.

As the list of wiring methods considered to be a raceway included in the previous definition was incomplete, it was removed from the definition of a raceway. A new *Informational Note* was added to indicate that the definition of a raceway can be identified within the specific wiring method article definition.

The following is a list of article definitions that were changed or revised due to the revised definition of *raceway* in Article 100 of the 2014 NEC:

352.2 - *Rigid polyvinyl chloride conduit (PVC)* removed the word "conduit" and added *raceway* within the definition (ROP 8-63).

354.2 - *Nonmetallic underground conduit with conductors (NUCC)* removed the word "conduit" and added *raceway* in the definition (ROP 8-73)

355.2 - *Reinforced thermosetting resin conduit (RTRC)*] removed the word "conduit" and added *raceway* within the definition (ROP 8-75).

356.2 - *Liquidtight flexible nonmetallic conduit (LFNC)*] removed the word "conduit" and added *raceway* within the definition at (2) and (3) (ROP 8-80).

368.2 - *Busway* inserted the term "A *raceway* consisting of a..." at the beginning of the definition (ROP 8-105).

376.2 - *Metal wireways* removed the word "wireway" and inserted *raceway* for the housing and protection of electrical conductors (ROP 8-132).

378.2 - *Nonmetallic wireways* removed the word "wireway" and inserted *raceway*

Retrofit Kit

The NEC added a new definition for the term *retrofit kit* to Article 100.

NEC Language

Retrofit Kit. A general term for a complete subassembly of parts and devices for field conversion of utilization equipment.

Comments

The 2011 *NEC* did not provide the term *retrofit kit* nor a definition of the same.

This term applies to LED listed retrofit kits used for luminaires and signs as referenced by new requirements in Articles 410 and 600.

Retrofit kits are not unique to luminaires, signs and outline lighting.

Sealable Equipment

An *Informational Note* was added to the definition of *Sealable Equipment*.

NEC Language

Sealable Equipment. Equipment enclosed in a case or cabinet that is provided with a means of sealing or locking so that live parts cannot be made accessible without opening the enclosure. The equipment may or may not be operable without opening the enclosure.

Informational Note: The equipment may or may not be operable without opening the enclosure.

Separately Derived System

The NEC revised the definition of *separately derived system* to clarify that the required grounding and bonding may create a connection between systems and that separately derived systems are not services.

NEC Language

Separately Derived System. An electrical source, other than a service, having no direct connection(s) to circuit conductors of any other electrical source other than those established by grounding and bonding connections.

Specific changes made to this paragraph from NEC 2011 are as follows:

~~A premises wiring system whose power is derived from a source of electric energy or equipment. An electrical source, other than a service, having no direct connection(s) to circuit conductors of any other electrical source other than those established by grounding and bonding connections. Such systems have no direct connection from circuit conductors of one system to circuit conductors of another system, other than connections through the earth, metal enclosures, metallic raceways, or equipment grounding conductors.~~

Comments

The previous definition of *Separately Derived System* implied that any wiring system whose source is derived from a service cannot be considered a separately derived system and that another source would be needed in order to have a separately derived system.

However, the fact is that a wiring system supplied through a transformer that is not supplied by the utility but with its source derived from a service can indeed be a separately derived system if other requirements of separately derived system are met (i.e., no direct connection from circuit conductors of one system to circuit conductors of another system).

The previous definition also described these "no direct connection from circuit conductors of one system to circuit conductors of another system" as being "the earth, metal enclosures, metallic raceways, or equipment grounding conductors."

The revised definition was simplified and indicates that the required grounding and bonding may create a connection between systems and that this condition does not disqualify this system from being a separately derived system. This revised definition also clarifies that a separately derived system is not a service but can have its source derived from a service.

Substation

The definition of *substation* was relocated from 225.2 to Article 100 and revised for clarity.

NEC Language

Substation. An enclosed assemblage of equipment (e.g., switches, interrupting devices, circuit breakers, buses, and transformers) through which electric energy is passed for the purpose of distribution, switching, or modifying its characteristics.

Specific changes made to this paragraph from NEC 2011 were as follows:

An enclosed assemblage of equipment (e.g., switches, interrupting devices, circuit breakers, buses, and transformers) ~~under the control of qualified persons~~, through which electric energy is passed for the purpose of distribution, switching, or modifying its characteristics.

Switchboard

The NEC modified the definition of *Switchboard*.

NEC Language

Switchboard. A large single panel, frame, or assembly of panels on which are mounted on the face, back, or both, switches, overcurrent and other protective devices, buses, and usually instruments. These assemblies are generally accessible from the rear as well as from the front and are not intended to be installed in cabinets.

Switchgear

The NEC revised the definition of *metal enclosed power switchgear* to *switchgear*.

NEC Language

Switchgear. An assembly completely enclosed on all sides and top with sheet metal (except for ventilating openings and inspection windows) and containing primary power circuit switching, interrupting devices, or both, with buses and connections. The assembly may include control and auxiliary devices. Access to the interior of the enclosure is provided by doors, removable covers, or both.

Informational Note: All switchgear subject to NEC requirements is metal enclosed. Switchgear rated below 1000 V or less may be identified as "low-voltage power circuit breaker switchgear." Switchgear rated over 1000 V may be identified as "metal-enclosed switchgear" or "metal-clad switchgear." Switchgear is available in non-arc-resistant or arc-resistant constructions.

Specific changes from NEC 2011 are as follows:

An ~~A-switchgear~~ assembly completely enclosed on all sides and top with sheet metal (except for ventilating openings and inspection windows) and containing primary power circuit switching, interrupting devices, or both, with buses and connections. The assembly may include control and auxiliary devices. Access to the interior of the enclosure is provided by doors, removable covers, or both. ~~Metal-enclosed power switchgear is available in non-arc-resistant or arc-resistant constructions.~~

Comments

A revision to the definition for *metal-enclosed power switchgear* removed the words "metal-enclosed power" to simplify the new term to simply *switchgear*. This new term will address all types of switchgear, and a new *Informational Note* includes a list of switchgear types to which the revised definition will apply.

Voltage, Nominal

The NEC added an *Informational Note* to **Voltage, Nominal**.

NEC Language

Voltage, Nominal. A nominal value assigned to a circuit or system for the purpose of conveniently designating its voltage class (e.g., 120/240 volts, 480Y/277 volts, 600 volts). The

actual voltage at which a circuit operates can vary from the nominal within a range that permits satisfactory operation of equipment.

Informational Note No. 1: The actual voltage at which a circuit operates can vary from the nominal within a range that permits satisfactory operation of equipment.

Informational Note No. 2: See ANSI C84.1-2006, Voltage Ratings for Electric Power Systems and Equipment (60 Hz).

II. Over 600 Volts, Nominal

NEC Language

Part II contains definitions applicable only to the articles and parts of articles specifically covering installations and equipment operating at over 600 volts, nominal.

The definitions in Part I are intended to apply wherever the terms are used throughout this *Code*. The definitions in Part II are applicable only to articles and parts of articles specifically covering installations and equipment operating at over 600 volts, nominal.

Electronically Actuated Fuse

An overcurrent protective device that generally consists of a control module that provides current sensing, electronically derived time–current characteristics, energy to initiate tripping, and an interrupting module that interrupts current when an overcurrent occurs. Electronically actuated fuses may or may not operate in a current-limiting fashion, depending on the type of control selected.

Fuse

An overcurrent protective device with a circuit opening fusible part that is heated and severed by the passage of overcurrent through it.

Informational Note: A fuse comprises all the parts that form a unit capable of performing the prescribed functions. It may or may not be the complete device necessary to connect it into an electrical circuit.

Controlled Vented Power Fuse

A fuse with provision for controlling discharge circuit interruption such that no solid material may be exhausted into the surrounding atmosphere.

Informational Note: The fuse is designed so that discharged gases will not ignite or damage insulation in the path of the discharge or propagate a flashover to or between grounded members or conduction members in the path of the discharge where the distance between the vent and such insulation or conduction members conforms to manufacturer's recommendations.

Expulsion Fuse Unit (Expulsion Fuse)

A vented fuse unit in which the expulsion effect of gases produced by the arc and lining of the fuseholder, either alone or aided by a spring, extinguishes the arc.

Nonvented Power Fuse

A fuse without intentional provision for the escape of arc gases, liquids, or solid particles to the atmosphere during circuit interruption.

Power Fuse Unit

A vented, nonvented, or controlled vented fuse unit in which the arc is extinguished by being drawn through solid material, granular material, or liquid, either alone or aided by a spring.

Vented Power Fuse

A fuse with provision for the escape of arc gases, liquids, or solid particles to the surrounding atmosphere during circuit interruption.

Multiple Fuse

An assembly of two or more single-pole fuses.

Switching Device

A device designed to close, open, or both, one or more electrical circuits.

Circuit Breaker

A switching device capable of making, carrying, and interrupting currents under normal circuit conditions, and also of making, carrying for a specified time, and interrupting currents under specified abnormal circuit conditions, such as those of short circuit.

Cutout

An assembly of a fuse support with either a fuseholder, fuse carrier, or disconnecting blade. The fuseholder or fuse carrier may include a conducting element (fuse link) or may act as the disconnecting blade by the inclusion of a nonfusible member.

Disconnecting Means

A device, group of devices, or other means whereby the conductors of a circuit can be disconnected from their source of supply.

Disconnecting (or Isolating) Switch (Disconnecter, Isolator)

A mechanical switching device used for isolating a circuit or equipment from a source of power.

Interrupter Switch

A switch capable of making, carrying, and interrupting specified currents.

Oil Cutout (Oil-Filled Cutout)

A cutout in which all or part of the fuse support and its fuse link or disconnecting blade is mounted in oil with complete immersion of the contacts and the fusible portion of the conducting element

Article 110 — Requirements for Electrical Installations

Introduction

Article 110 sets the stage for how to implement the rest of the NEC. This article contains a few of the most important and yet neglected parts of the Code. For example:

How should you terminate conductors?

What kinds of warnings, markings, and identification does a given installation require?

What is the right working clearance for a given installation?

What do the temperature limitations at terminals mean?

What are the NEC requirements for dealing with flash protection?

I. General

Changed From NEC 2011

110.1 Scope

This article covers general requirements for the examination and approval, installation and use, access to and spaces about electrical conductors and equipment; enclosures intended for personnel entry; and tunnel installations.

Informational Note sends you to Annex J for ADA accessibility design.

110.1 Scope

Informational Note: See Informative Annex J for information regarding ADA accessibility design.

110.9 Interrupting Rating

The NEC modified the paragraph for clarity.

NEC Language

110.9 Interrupting Rating

Equipment intended to interrupt current at fault levels shall have an interrupting rating at nominal circuit voltage sufficient for the current that is available at the line terminals of the equipment.

Equipment intended to interrupt current at other than fault levels shall have an interrupting rating at nominal circuit voltage sufficient for the current that must be interrupted.

110.12 Mechanical Execution of Work.

The **Informational Note** updated its reference.

NEC Language

Electrical equipment shall be installed in a neat and workmanlike manner.

Informational Note: Accepted industry practices are described in ANSI/NECA 1-2010, *Standard Practice of Good Workmanship in Electrical Construction*, and other ANSI approved installation standards.

110.14 Electrical Connections

NEC Language

Because of different characteristics of dissimilar metals, devices such as pressure terminal or pressure splicing connectors and soldering lugs shall be identified for the material of the conductor and shall be properly installed and used. Conductors of dissimilar metals shall not be intermixed in a terminal or splicing connector where physical contact occurs between dissimilar conductors (such as copper and aluminum, copper and copper-clad aluminum, or aluminum and copper-clad aluminum), unless the device is identified for the purpose and conditions of use.

Changes in the 2014 National Electrical Code (NEC®): Articles 90, 100, and 110

Materials such as solder, fluxes, inhibitors, and compounds, where employed, shall be suitable for the use and shall be of a type that will not adversely affect the conductors, installation, or equipment.

Connectors and terminals for conductors more finely stranded than Class B and Class C stranding as shown in Chapter 9, Table 10, shall be identified for the specific conductor class or classes.

110.14 Electrical Connections

The NEC clarified the *Informational Note*.

NEC Language

110.14 Electrical Connections

Informational Note: Many terminations and equipment are either marked with tightening torque or are identified as to tightening torque in the installation instructions provided.

110.16 Arc-Flash Hazard Warning

The revision to *Arc-Flash Hazard Warning* adds the words "or factory" to the rule to clarify that the required arc-flash warning label could be applied in the field or at the factory by a manufacturer.

NEC Language

110.16 Arc-Flash Hazard Warning

Electrical equipment, such as switchboards, switchgear, panelboards, industrial control panels, meter socket enclosures, and motor control centers, that are in other than dwelling units, and are likely to require examination, adjustment, servicing, or maintenance while energized shall be field or factory marked to warn qualified persons of potential electric arc flash hazards. The marking shall meet the requirements in 110.21(B) and shall be located so as to be clearly visible to qualified persons before examination, adjustment, servicing, or maintenance of the equipment.

Comments

This arc-flash warning label for electrical equipment likely to require examination, adjustment, servicing, or maintenance while energized was required to be a "field marking" to be applied by the installer.

The words "or factory" were added to 110.16 to allow the required arc-flash warning label to be applied in the field by the installer or at the factory by a manufacturer.

110.21 Marking

The NEC added a new subsection for *Field Applied Hazard Markings* for specific requirements for warning labels and similar markings required elsewhere in the *Code*.

NEC Language

110.21 Marking

(A) Manufacturer's Markings. The manufacturer's name, trademark, or other descriptive marking by which the organization responsible for the product can be identified shall be placed on all electrical equipment. Other markings that indicate voltage, current, wattage, or other ratings shall be provided as specified elsewhere in this *Code*. The marking or label shall be of sufficient durability to withstand the environment involved.

(B) Field-Applied Hazard Markings. Where caution, warning, or danger signs or labels are required by this *Code*, the labels shall meet the following requirements:

(1) The marking shall adequately warn of the hazard using effective words and/or colors and/or symbols.

Informational Note: ANSI Z535.4-2011, *Product Safety Signs and Labels*, provides guidelines for suitable font sizes, words, colors, symbols, and location requirements for labels.

(2) The label shall be permanently affixed to the equipment or wiring method and shall not be hand written.

Exception to (2): Portions of labels or markings that are variable, or that could be subject to changes, shall be permitted to be hand written and shall be legible.

(3) The label shall be of sufficient durability to withstand the environment involved.

Informational Note: ANSI Z535.4-2011, *Product Safety Signs and Labels*, provides guidelines for the design and durability of safety signs and labels for application to electrical equipment.

Comments

A new 110.21(B), *Field-Applied Hazard Markings*, was added for specific one-stop requirements for warning labels and similar markings required elsewhere in the *Code*.

This new requirement incorporates uniformity to rules where additional direction and guidance were needed.

110.22 Identification of Disconnecting Means

The NEC added marking requirements

NEC Language

110.22 Identification of Disconnecting Means

(A) General. Each disconnecting means shall be legibly marked to indicate its purpose unless located and arranged so the purpose is evident. The marking shall be of sufficient durability to withstand the environment involved.

(B) Engineered Series Combination Systems. Equipment enclosures for circuit breakers or fuses applied in compliance with series combination ratings selected under engineering supervision in accordance with 240.86(A) shall be legibly marked in the field as directed by the

engineer to indicate the equipment has been applied with a series combination rating. The marking shall meet the requirements in 110.21(B) and shall be readily visible and state the following:

CAUTION — ENGINEERED SERIES COMBINATION SYSTEM RATED _____ AMPERES.
IDENTIFIED REPLACEMENT COMPONENTS REQUIRED.

(C) Tested Series Combination Systems

This was revised to clarify that the marking is required on the enclosure and that the enclosure may also contain fuses as well as a circuit breaker.

NEC Language

110.22(C) Tested Series Combination Systems

Equipment enclosures for circuit breakers or fuses applied in compliance with the series combination ratings marked on the equipment by the manufacturer in accordance with 240.86(B) shall be legibly marked in the field to indicate the equipment has been applied with a series combination rating. The marking shall meet the requirements in 110.21(B) and shall be readily visible and state the following:

CAUTION — SERIES COMBINATION SYSTEM RATED ____ AMPERES.
IDENTIFIED REPLACEMENT COMPONENTS REQUIRED.

110.24 Available Fault Current

(A) Field Marking

The NEC added a new *Informational Note* to clarify that the available fault current markings are for equipment rating purposes and not for arc-flash hazard analysis as required by NFPA 70E.

This section requires service equipment (other than dwelling units) to be field-marked with the amount of available short-circuit current when installed or modified.

NEC Language

110.24 Available Fault Current

(A) Field Marking. Service equipment in other than dwelling units shall be legibly marked in the field with the maximum available fault current. The field marking(s) shall include the date the fault current calculation was performed and be of sufficient durability to withstand the environment involved.

Informational Note: The available fault-current marking(s) addressed in 110.24 is related to required shortcircuit current ratings of equipment. NFPA 70E-2012, Standard for Electrical Safety in the Workplace, provides assistance in determining the severity of potential exposure, planning safe work practices, and selecting personal protective equipment.

Comments

This new *Informational Note* clarifies that the available fault-current markings required at 110.24 are related to proper application of electrical equipment with regard to the maximum level of available fault current.

These markings are a starting point for installers and enforcers of the *Code* when they are selecting proper equipment with sufficient interrupting ratings and short-circuit ratings for the application involved.

This value of available fault current marked on the equipment should not be used for arc-flash hazard analysis studies covered by NFPA 70E addressing workplace safety.

110.25 Lockable Disconnecting Means

The NEC added a new 110.25 in Article 110 to provide consistent requirements at one location for lockable disconnecting means rules.

NEC Language

Where a disconnecting means is required to be lockable open elsewhere in this *Code*, it shall be capable of being locked in the open position. The provisions for locking shall remain in place with or without the lock installed.

Exception: Cord-and-plug connection locking provisions shall not be required to remain in place without the lock installed.

Comments

Requirements for a disconnecting means to be "lockable in the open position" existed in a number of locations in the 2011 *NEC*. This new section consolidates these numerous requirements throughout the *Code* into one location in Article 110 for uniformity and clarity.

II. 600 Volts, Nominal, or Less

Changed From NEC 2011

110.26 Spaces About Electrical Equipment

(C) Entrance to and Egress from Working Space.

(3) Personnel Doors

The NEC lowered the ampere value related to provisions for "Personnel doors" for "Entrance to and Egress from Working Space" to 800 amperes from 1200 amperes. The term *listed panic hardware* replaces the previous list of specific hardware provided at this requirement.

NEC Language

110.26 Spaces About Electrical Equipment

Access and working space shall be provided and maintained about all electrical equipment to permit ready and safe operation and maintenance of such equipment.

(C) Entrance to and Egress from Working Space.

(3) Personnel Doors

Where equipment rated 800 A or more that contains overcurrent devices, switching devices, or control devices is installed and there is a personnel door(s) intended for entrance to and egress from the working space less than 7.6 m (25 ft) from the nearest edge of the working space, the door(s) shall open in the direction of egress and be equipped with listed panic hardware bars, pressure plates, or other devices that are normally latched but open under simple pressure.

110.26 Space about Electrical Equipment

(E) Dedicated Equipment Space

(2) Outdoor

(a) Installation Requirements and (b) Dedicated Equipment Space

Dedicated equipment space is now required for both outdoor installations and for indoor installations.

NEC Language

110.26 Space about Electrical Equipment

(E) Dedicated Equipment Space

All switchboards, switchgear, panelboards, and motor control centers shall be located in dedicated spaces and protected from damage.

Exception: Control equipment that by its very nature or because of other rules of the Code must be adjacent to or within sight of its operating machinery shall be permitted in those locations.

(1) Indoor. *(Text unchanged)*

(2) Outdoor. Outdoor installations shall comply with 110.26(E)(2)(a) and (b).

(a) Installation Requirements.

Outdoor electrical equipment shall be installed in suitable enclosures and shall be protected from accidental contact by unauthorized personnel, or by vehicular traffic, or by accidental spillage or leakage from piping systems. The working clearance space shall include the zone described in 110.26(A). No architectural appurtenance or other equipment shall be located in this zone.

(b) Dedicated Equipment Space.

The space equal to the width and depth of the equipment and extending from grade to a height of 1.8 m (6 ft) above the equipment shall be dedicated to the electrical installation. No piping or other equipment foreign to the electrical installation shall be located in this zone.

Comments

A space equal to the width and depth of the electrical equipment and extending from grade to a height of 1.8 m (6 ft) above all indoor switchboards, panelboards, and motor control centers is required to be located above and below such equipment. This space is known as *dedicated electrical or equipment space*.

This space is to be dedicated to the electrical installation (*electrical conduits, cables, equipment, etc., only; no equipment foreign to the electrical installation*).

However, in the 2011 *NEC*, this dedicated electrical space requirement applied only to indoor installations.

This new requirement calls for the same basic dedicated equipment or electrical space for outdoor installations that has been in effect for indoor installations at 110.26 since the 1999 *NEC*.

110.27 Guarding of Live Parts

(A) Live Parts Guarded Against Accidental Contact

(4)

A revision for "Guarding of Live Parts" increases the elevation of live parts against accidental contact to 2.6 m (8½ ft.) when voltages range from 301 to 600 volts.

NEC Language

110.27 Guarding of Live Parts

(A) Live Parts Guarded Against Accidental Contact

Except as elsewhere required or permitted by this Code, live parts of electrical equipment operating at 50 volts or more shall be guarded against accidental contact by approved enclosures or by any of the following means:

(1) By location in a room, vault, or similar enclosure that is accessible only to qualified persons.

(2) By suitable permanent, substantial partitions or screens arranged so that only qualified persons have access to the space within reach of the live parts.

Any openings in such partitions or screens shall be sized and located so that persons are not likely to come into accidental contact with the live parts or to bring conducting objects into contact with them.

(3) By location on a suitable balcony, gallery, or platform elevated and arranged so as to exclude unqualified persons.

(4) By elevation of ~~2.5 m (8 ft) or more~~ above the floor or other working surface as shown in (a) or (b) below:

(a) a minimum of 2.5 m (8 ft) for 50 – 300 volts

(b) a minimum of 2.6 m (8½ ft) for 301 to 600 volts.

Comments

Live parts of electrical equipment operating at 50 volts or more are required to be guarded against accidental contact by approved enclosures or by 4 specific methods described at 110.27(A).

Level 2 list item (4) permitted elevation of 2.5 m (8 ft) or more above the floor or other working surfaces.

In the 2011 NEC, this elevation provision applied to all applications, regardless of the voltage involved.

A revision to 110.27(A)(4) increased the elevation of live parts against accidental contact to 2.6 m (8½ ft.) when voltages range from 301 to 600 volts.

Live parts of electrical equipment with 50 to 300 volts can still comply with this requirement with a minimum of 2.5 m (8 ft) above the floor or other working surface.

A revision to 110.27(A)(4) for elevation of live parts of electrical equipment operating at 50 volts or more to be guarded against accidental contact was raised to 2.6 m (8½ ft.) when voltages range from 301 to 600 volts. This 2.6 m (8½ ft) clearance corresponds with the National Electrical Safety Code (NESC) clearances for live exposed parts (see NESC 124A3 and Table 124-1).

Changes in the 2014 National Electrical Code (NEC®): Articles 90, 100, and 110

Table 124-1 of the NESC does separate voltages of 300 volts (phase-to-phase) and below from those 301 to 600 volts for clearances for live exposed parts.

Typically, clearances of any sort in the NEC are determined by different factors and conditions. One of these factors is a base reference of height for the activity involved in the vicinity of different components to be cleared.

Changes in the 2014 National Electrical Code (NEC®): Articles 90, 100, and 110

Conclusion

Summary

You have completed Articles 90, 100, and 110 of this course on *Changes in the 2014 NEC*.

Resources

References

1. National Fire Protection Association, Inc. Quincy, MA. *2014 National Electrical Code (NEC)*, 2013.
2. International Association of Electrical Inspectors, Richardson, Texas and National Fire Protection Association, Inc. Quincy, MA. *Analysis of Changes – NEC 2014*. 2013.
3. Keith Lofland. *Analysis of Changes, 2014 NEC*. IAEI Magazine.

The designations "National Electrical Code" and "NEC" refer to NFPA 70, National Electrical Code, which is a registered trademark of the National Fire Protection Association.

Author Biography

Neal L. Burdick

Neal Burdick has over 30 years of experience and is currently a Construction Inspector for the City of Tampa. He is a registered instructor for the Electrical Council of Florida and is the author and instructor of a State of Florida approved Electrical Contractor's Licensing Board course.

Neal is an accomplished and exceptionally knowledgeable professional with a solid background in electrical and building inspections, as well as code compliance. He is recognized as an expert in this industry. He is an active member of IAEI, BOAF, ECF, and related industry associations. Mr. Burdick conducts training to Building Officials, Engineers, Plans Examiners, Inspectors, Electrical Contractors, and Apprentices throughout the State of Florida.



Changes in the 2014 National Electrical Code (NEC[®]): Chapter 2 — Wiring and Protection

Table of Contents

Introduction	4
Course Overview	4
Learning Objectives	4
ARTICLE 200 — Use and Identification of Grounded Conductors	5
200.4 Neutral Conductors	5
200.6 Means of Identifying Grounded Conductors	7
ARTICLE 210 — Branch Circuits	8
210.5 Identification for Branch Circuits	8
210.8 — Ground-Fault Circuit-Interrupter — Protection for Personnel	10
210.8(D) Ground-Fault Circuit Interrupter Protection for Personnel	12
210.12 Arc-Fault Circuit-Interrupter Protection	14
210.13 Ground Fault Protection of Equipment	19
210.17 Electric Vehicle Branch Circuit	20
210.52 Dwelling Unit Receptacle Outlets	20
210.64 Electrical Service Areas	23
ARTICLE 220 Branch-Circuit, Feeder, and Service Calculations	24
220.3 Application of Other Articles	24
220.12 Lighting Load for Specified Occupancies	25
225.52 Disconnecting Means	26
ARTICLE 230 Services	27
230.30 Installation. (Underground Service Conductors)	27
230.44 Cable Trays	28
230.82 Equipment Connected to the Supply Side of Service Disconnect	29
ARTICLE 240 Overcurrent Protection	30
240.21 Location in Circuit	30
240.87 Arc Energy Reduction	31
ARTICLE 250 Grounding and Bonding	33
250.8 Connection of Grounding and Bonding Equipment	33
250.21 Alternating-Current Systems of 50 Volts to Less Than 1000 Volts Not Required to Be Grounded	34
250.24 Grounding Service Supplied Alternating-Current Systems	35
250.64 Grounding Electrode Conductor Installation	36

Changes in the 2014 National Electrical Code (NEC®): Chapter 2 — Wiring and Protection

250.66 Size of Alternating Current Grounding Electrode Conductor	39
250.68 Grounding Electrode Conductor and Bonding Jumper Connection to Grounding Electrodes	40
250.102 Bonding Conductors and Jumpers	42
250.122 Size of Equipment Grounding Conductors	44
250.130 Equipment Grounding Conductor Connections	45
250.166 Size of the Direct-Current Grounding Electrode Conductor	46
250.167 Direct-Current Ground-Fault Detection	47
250.186 Ground-Fault Circuit Conductor Brought to Service Equipment	48
250.194 Grounding and Bonding of Fences and Other Metal Structures	49
ARTICLE 285 Surge-Protective Devices (SPDs), 1000 Volts or Less	51
285.13 Type 4 and Other Component Type SPDs	51
Conclusion	52
Summary	52
Resources	52
References	52
Author Biography	53
Neal L. Burdick	53

Introduction

Course Overview

This is the **second** of several courses covering the changes in the 2014 edition of the **National Electrical Code** (NEC) created by the NFPA.

This course provides coverage of significant changes in the *2014 National Electrical Code*. With every new edition of the NEC, some of the changes include new requirements to sections, while some of the changes include entirely new articles. Some changes are revisions to existing requirements while others are deletions to some existing requirements.

Although not required, **it is recommended to have a copy of the 2014 NEC manual for reference**, especially when reviewing information in large tables.

A **Summary of each change** is followed by the actual NEC Language, with deletions showing with a ~~strikethrough~~ and additions/changes (highlighted in yellow). When necessary, **Comments** are added to appropriate topics.

In many cases, paragraphs not directly affected by a change are retained to preserve context. *There will be no quiz questions on material that does not cover changes in the 2014 NEC.*

The length of each segment varies depending on the topic and material available.

A final quiz at the end of the course helps demonstrate your understanding of the material.

The National Electrical Code is intended for electricians and subcontractors, electrical inspectors, electrical engineers, designers, and other qualified persons who understand electrical currents, theory, safety procedures, and electrical trade practices. The code does not serve as a teaching manual for untrained individuals.

Chapter 2 is primarily concerned with correctly sizing and protecting circuits. Every article in this chapter deals with different aspects of this purpose.

This differs from the purpose of Chapter 3, which is to correctly install the conductors that make up those circuits.

Learning Objectives

At the end of this course, you will be able to:

- Identify the various significant changes in Chapter 2 of the NEC
- Refer to the appropriate sections of the code and find applicable changes
- Recognize the reason for each change
- Apply each change as necessary
- Refer to the appropriate tables to extract relevant information

ARTICLE 200 — Use and Identification of Grounded Conductors

200.4 Neutral Conductors

NEC Language

Article 200 provides requirements for the following:

- (1) Identification of terminals
- (2) Grounded conductors in premises wiring systems
- (3) Identification of grounded conductors

Informational Note: See Article 100 for definitions of Grounded Conductor, Equipment Grounding Conductor, and Grounding Electrode Conductor.

Changed from NEC 2011

200.4(B) Multiple Circuits

New provisions in the 2014 NEC require grouping the common neutral conductor for multiple circuits with its associated ungrounded conductors when contained in the same enclosure.

NEC Language

200.4 Neutral Conductors

Neutral conductors shall be installed in accordance with 200.4(A) and (B).

(A) Installation. Neutral conductors shall not be used for more than one branch circuit, for more than one multiwire branch circuit, or for more than one set of ungrounded feeder conductors unless specifically permitted elsewhere in this Code.

(B) Multiple Circuits

If more than one neutral conductor associated with different circuits is in an enclosure, grounded circuit conductors of each circuit shall be identified or grouped to correspond with the ungrounded circuit conductor(s) by wire markers, cable ties, or similar means in at least one location within the enclosure.

Exception No. 1: The requirement for grouping or identifying shall not apply if the branch circuit or feeder conductors enter from a cable or a raceway unique to the circuit that makes the grouping obvious.

Exception No. 2: The requirement for grouping or identifying shall not apply where branch circuit conductors pass through a box or conduit body without a loop as described in 314.16(B)(1) or without a splice or termination.

Comments

Section 200.4 of the 2011 NEC, prohibited a neutral conductor from being used for more than one branch circuit, multiwire branch circuit, or for more than one feeder.

The new 200.4(B), *Multiple Circuits*, requires grouping the common neutral conductor for multiple circuits with their associated ungrounded conductors when contained in the same enclosure.

The 2014 NEC also added new exceptions to relax this grouping requirement where the grouping is obvious or where looped conductors or conductors simply pass through the enclosure.

200.6 Means of Identifying Grounded Conductors.

(A) Sizes 6 AWG or Smaller

(3)

A revision permits three continuous white "or gray" stripes along the grounded conductor's entire length on other than green insulation for identification of sizes 6 AWG or smaller.

NEC Language

200.6 Means of Identifying Grounded Conductors.

(A) Sizes 6 AWG or Smaller

An insulated grounded conductor of 6 AWG or smaller shall be identified by one of the following means:

(1) A continuous white outer finish.

(2) A continuous gray outer finish.

(3) Three continuous white or gray stripes along the conductor's entire length on other than green insulation.

(4) Wires that have their outer covering finished to show a white or gray color but have colored tracer threads in the braid identifying the source of manufacture shall be considered as meeting the provisions of this section.

(5) The grounded conductor of a mineral-insulated, metal-sheathed cable (Type MI) shall be identified at the time of installation by distinctive marking at its terminations.

Comments

With improvements in compounds and coloring methods from conductor manufacturers, white and gray skim coats for insulation and stripes are now easily distinguishable.

Gray coloring for grounded conductors is frequently requested for 277/480-volt circuits, making gray stripes a natural addition to the acceptable means of identification for grounded conductors.

ARTICLE 210 — Branch Circuits

210.5 Identification for Branch Circuits

This article contains the requirements for branch circuits, such as conductor sizing and identification, GFCI protection and receptacle and lighting outlet requirements.

Changed from NEC 2011

(C) Identification of Ungrounded Conductors

(2) Branch Circuits Supplied From Direct Current Systems

New branch circuit identification requirements were added for dc systems. Sizes 6 AWG and smaller will be identified by red for positive dc conductors and by black for negative dc conductors.

NEC Language

210.5 Identification for Branch Circuits

(A) Grounded Conductor. The grounded conductor of a branch circuit shall be identified in accordance with 200.6.

(B) Equipment Grounding Conductor. The equipment grounding conductor shall be identified in accordance with 250.119.

(C) Identification of Ungrounded Conductors. Ungrounded conductors shall be identified in accordance with 210.5(C)(1), or (2), and (3) as applicable.

(1) Application Branch Circuits Supplied From More Than One Nominal Voltage System.

Where the premises wiring system has branch circuits supplied from more than one nominal voltage system, each ungrounded conductor of a branch circuit shall be identified by phase or line and system at all termination, connection, and splice points in compliance with 210.5(C)(1)(a) and (b).

(a) Means of Identification. The means of identification shall be permitted to be by separate color coding, marking tape, tagging, or other approved means.

(b) Posting of Identification Means. The method utilized for conductors originating within each branch-circuit panelboard or similar branch-circuit distribution equipment shall be documented in a manner that is readily available or shall be permanently posted at each branch-circuit panelboard or similar branch-circuit distribution equipment.

(2) Branch Circuits Supplied From Direct Current Systems. Where a branch circuit is supplied from a dc system operating at more than 50 volts, each ungrounded conductor of 4 AWG or larger shall be identified by polarity at all termination, connection, and splice points by marking tape, tagging, or other approved means; each ungrounded conductor of 6 AWG or smaller shall be identified by polarity at all termination, connection, and splice points in

compliance with 210.5(C)(2)(a) and (b). The identification methods utilized for conductors originating within each branch-circuit panelboard or similar branch-circuit distribution equipment shall be documented in a manner that is readily available or shall be permanently posted at each branch-circuit panelboard or similar branch-circuit distribution equipment.

(a) Positive Polarity, Sizes 6 AWG or Smaller. Where the positive polarity of a dc system does not serve as the connection point for the grounded conductor, each positive ungrounded conductor shall be identified by one of the following means:

(1) A continuous red outer finish.

(2) A continuous red stripe durably marked along the conductor's entire length on insulation of a color other than green, white, gray, or black.

(3) Imprinted plus signs "+" or the word "POSITIVE" or "POS" durably marked on insulation of a color other than green, white, gray, or black, and repeated at intervals not exceeding 610 mm (24 in.) in accordance with 310.120(B).

(b) Negative Polarity, Sizes 6 AWG or smaller. Where the negative polarity of a dc system does not serve as the connection point for the grounded conductor, each negative ungrounded conductor shall be identified by one of the following means:

(1) A continuous black outer finish.

(2) A continuous black stripe durably marked along the conductor's entire length on insulation of a color other than green, white, gray, or red.

(3) Imprinted minus signs "-" or the word "NEGATIVE" or "NEG" durably marked on insulation of a color other than green, white, gray, or red, and repeated at intervals not exceeding 610 mm (24 in.) in accordance with 310.120(B).9

Comments

210.5(C)(2) now provides new branch circuit identification requirements for dc circuits.

For branch circuits supplied from a dc system operating at more than 50 volts, each ungrounded conductor of 4 AWG or larger is to be identified by polarity at all termination, connection, and splice points by marking tape, tagging, or other approved means.

Direct current (dc) applications are experiencing a re-emergence in the electrical industry because of such things as electric vehicle charging, solar photovoltaic (PV) systems, microgrids, wind generated electric systems, etc.

210.8 — Ground-Fault Circuit-Interrupter — Protection for Personnel

(A) Dwelling Units

(7) Sinks

GFCI protection is required within 1.8 m (6 ft) of all dwelling unit sinks (including kitchen sinks).

NEC Language

Ground-fault circuit-interrupter protection ~~interruption~~ for personnel shall be provided as required in 210.8(A) through (C). The ground-fault circuit-interrupter shall be installed in a readily accessible location.

Informational Note: See 215.9 for ground-fault circuit-interrupter protection for personnel on feeders.

(A) **Dwelling Units.** All 125-volt, single-phase, 15- and 20-ampere receptacles installed in the locations specified in 210.8(A)(1) through ~~(8)~~ (10) shall have ground-fault circuit-interrupter protection for personnel.

(7) **Sinks** — ~~located in areas other than kitchens~~ Where receptacles are installed within 1.8 m (6 ft) of the outside edge of the sink.

Comments

A revision to 210.8(A)(7) for GFCI protection for dwelling unit sinks removes the words "located in areas other than kitchens" to require GFCI protection for all 125-volt, single-phase, 15- and 20-ampere receptacles installed within 1.8 m (6 ft) of the outside edge of dwelling unit sinks (including kitchen sinks).

This change should bring some consistency to the "within 1.8 m (6 ft) of the outside edge of dwelling unit sink" requirements as a receptacle for such things as an appliance (refrigerator, washing machine, etc.) would require GFCI protection if it were located within 1.8 m (6 ft) of a wet bar sink; but under previous editions of the Code, these were not required to be GFCI-protected if this same receptacle were located within 1.8 m (6 ft) of a kitchen sink.

(9) Bathtubs or Shower Stalls

GFCI protection is now required where receptacles are installed within 1.8 m (6 ft) of the outside edge of dwelling unit bathtubs or shower stalls.

NEC Language

Ground-fault circuit-interrupter protection ~~interruption~~ for personnel shall be provided as required in 210.8(A) through (C). The ground-fault circuit-interrupter shall be installed in a readily accessible location.

Informational Note: See 215.9 for ground-fault circuit-interrupter protection for personnel on feeders.

(A) Dwelling Units. All 125-volt, single-phase, 15- and 20-ampere receptacles installed in the locations specified in 210.8(A)(1) through ~~(8)~~ (10) shall have ground fault circuit-interrupter protection for personnel.

(9) Bathtubs or Shower Stalls

Where receptacles are installed within 1.8 m (6 ft) of the outside edge of the bathtub or shower stall.

Comments

A new 210.8(A)(9) for bathtubs or shower stalls now requires GFCI protection for all 125-volt, single-phase, 15- and 20-ampere receptacles installed within 1.8 m (6 ft) of the outside edge of a dwelling unit bathtub or shower stall, even if these bathtub or shower stalls are not located in a defined bathroom.

This new GFCI provision for dwelling unit bathtub and shower stall areas is a logical expansion as bathtubs or shower stalls are not always located in an area that meets the Article 100 definition of a bathroom, and any receptacles in such areas might not require GFCI protection.

(A) Dwelling Units

(10) Laundry areas

All dwelling unit laundry areas now require GFCI protection for 125-volt, single-phase, 15- and 20-ampere receptacles, regardless of the presence of a sink or the distance from the same.

NEC Language

Ground-fault circuit-interrupter protection ~~interruption~~ for personnel shall be provided as required in 210.8(A) through (C). The ground-fault circuit interrupter shall be installed in a readily accessible location.

Informational Note: See 215.9 for ground-fault circuit-interrupter protection for personnel on feeders.

(A) Dwelling Units. All 125-volt, single-phase, 15- and 20-ampere receptacles installed in the locations specified in 210.8(A) (1) through (8) (10) shall have ground-fault circuit-interrupter protection for personnel.

(10) Laundry areas

Comments

The presence of a laundry room sink is no longer the driving factor as to whether GFCI protection is required or not.

(B) Other Than Dwelling Units

(8) Garages, service bays, and similar areas

The NEC now requires GFCI protection for all 125-volt, single-phase, 15- and 20-ampere receptacles installed in all non-dwelling unit garages, service bays, and similar areas (other than vehicle exhibition halls and showrooms).

NEC Language

(B) Other Than Dwelling Units.

All 125-volt, single-phase, 15- and 20-ampere receptacles installed in the locations specified in 210.8(B)(1) through (8) shall have ground-fault circuit-interrupter protection for personnel.

(8) Garages, service bays, and similar areas ~~where electrical diagnostic equipment, electrical hand tools, or portable lighting equipment are to be used~~ other than vehicle exhibition halls and showrooms.

Comments

GFCI protection for personnel was required for all 125-volt, single-phase, 15- and 20-ampere receptacles installed in non-dwelling unit garages, service bays, and similar areas, but only in areas where electrical diagnostic equipment, electrical hand tools, or portable lighting equipment were to be used.

GFCI protection for personnel will now be required for all 125-volt, single-phase, 15- and 20-ampere receptacles installed in all non-dwelling unit garages, service bays, and similar areas (other than vehicle exhibition halls and showrooms).

(D) Kitchen Dishwasher Branch

The NEC now requires circuit GFCI protection for all outlets that supply dishwashers installed in dwelling units.

NEC Language

210.8(D) Ground-Fault Circuit Interrupter Protection for Personnel

Ground-fault circuit-interrupter protection ~~interruption~~ for personnel shall be provided as required in 210.8(A) through (C). The ground-fault circuit interrupter shall be installed in a readily accessible location.

Informational Note: See 215.9 for ground-fault circuit-interrupter protection for personnel on feeders.

(D) - Kitchen Dishwasher Branch Circuit. GFCI protection shall be provided for outlets that supply dishwashers installed in dwelling unit locations.

Comments

GFCI protection was (and is) required for all 125-volt, single-phase, 15- and 20-ampere receptacles installed in dwelling unit kitchens where those receptacles serve a kitchen countertop.

This provision was for receptacle outlets only and did not include hard-wired outlets and did not include receptacles that did not serve a kitchen countertop, such as a receptacle for a garbage disposal or a receptacle for a dishwasher installed behind the dishwasher under the countertop in the dishwasher space.

A new 210.8(D) now requires GFCI protection for all outlets that supply dishwashers installed in dwelling units. This would include a receptacle outlet or a direct-wired outlet for a dishwasher.

210.12 Arc-Fault Circuit-Interrupter Protection

A new provision now requires all AFCI devices mandated by 210.12 to be installed in a readily accessible location.

NEC Language

210.12 Arc-Fault Circuit-Interrupter Protection

Arc-fault circuit-interrupter protection shall be provided as required in 210.12(A), (B), and (C).

The arc-fault circuit interrupter shall be installed in a readily accessible location.

Comments

Accessibility to AFCI protective devices should be the same as that for GFCI devices.

With the option of a listed outlet branch-circuit type AFCI device, there is a possibility of these receptacle-type outlet devices being placed in a location that could easily place the AFCI device in a location that is not readily accessible.

This readily accessible feature to this new requirement for AFCI devices will also facilitate the ability to reset the AFCI device in the event the AFCI trips.

Changed from NEC 2011

210.12 Arc-Fault Circuit-Interrupter Protection

(A) Dwelling Units

Kitchens and laundry areas were added to the list of areas requiring AFCI protection. AFCI protection was also expanded from outlets only to outlets or devices, which would now include switches, etc.

NEC Language

210.12 Arc-Fault Circuit-Interrupter Protection

(A) Dwelling Units. All 120-volt, single phase, 15- and 20-ampere branch circuits supplying outlets or devices installed in dwelling unit kitchens, family rooms, dining rooms, living rooms, parlors, libraries, dens, bedrooms, sunrooms, recreation rooms, closets, hallways, laundry areas, or similar rooms or areas shall be protected by ~~a listed arc-fault circuit interrupter, combination-type, installed to provide protection of the branch circuit~~ any of the following means described in 210.12(A) (1) through (6):

(1) A listed combination-type arc-fault circuit interrupter, installed to provide protection of the entire branch circuit (2) A listed branch/feeder-type AFCI installed at the origin of the branch-circuit in combination with a listed outlet branch-circuit type arc-fault circuit interrupter installed at the first outlet box on the branch circuit. The first outlet box in the branch circuit shall be marked to indicate that it is the first outlet of the circuit.

(3) A listed supplemental arc protection circuit breaker installed at the origin of the branch circuit in combination with a listed outlet branch-circuit type arc-fault circuit interrupter installed at the first outlet box on the branch circuit where all of the following conditions are met:

- a. The branch-circuit wiring shall be continuous from the branch-circuit overcurrent device to the outlet branch-circuit arc-fault circuit interrupter.
- b. The maximum length of the branch-circuit wiring from the branch-circuit overcurrent device to the first outlet shall not exceed 15.2 m (50 ft) for a 14 AWG conductor or 21.3 m (70 ft) for a 12 AWG conductor.
- c. The first outlet box in the branch circuit shall be marked to indicate that it is the first outlet of the circuit.

(4) A listed outlet branch-circuit type arc-fault circuit interrupter installed at the first outlet on the branch circuit in combination with a listed branch-circuit overcurrent protective device where all of the following conditions are met:

- a. The branch-circuit wiring shall be continuous from the branch-circuit overcurrent device to the outlet branch-circuit arc-fault circuit interrupter.
- b. The maximum length of the branch-circuit wiring from the branch-circuit overcurrent device to the first outlet shall not exceed 15.2 m (50 ft) for a 14 AWG conductor or 21.3 m (70 ft) for a 12 AWG conductor.
- c. The first outlet box in the branch circuit shall be marked to indicate that it is the first outlet of the circuit.
- d. The combination of the branch-circuit overcurrent device and outlet branch-circuit AFCI shall be identified as meeting the requirements for a system combination-type AFCI and shall be listed as such.

(5) If RMC, IMC, EMT, Type MC, or steel-armored Type AC cables meeting the requirements of 250.118, metal wireways, metal auxiliary gutters, and metal outlet and junction boxes are installed for the portion of the branch circuit between the branch-circuit overcurrent device and the first outlet, it shall be permitted to install a listed outlet branch-circuit type AFCI at the first outlet to provide protection for the remaining portion of the branch circuit.

(6) Where a listed metal or nonmetallic conduit or tubing or Type MC cable is encased in not less than 50 mm (2 in.) of concrete for the portion of the branch circuit between the branch-circuit overcurrent device and the first outlet, it shall be permitted to install a listed outlet branch-circuit type AFCI at the first outlet to provide protection for the remaining portion of the branch circuit.

~~**Exception No. 1:** If RMC, IMC, EMT, Type MC, or steel armored Type AC cables meeting the requirements of 250.118 and metal outlet and junction boxes are installed for the portion of the branch circuit between the branch-circuit overcurrent device and the first outlet, it shall be~~

~~permitted to install an outlet branch-circuit type AFCI at the first outlet to provide protection for the remaining portion of the branch circuit.~~

~~**Exception No. 2:** Where a listed metal or nonmetallic conduit or tubing is encased in not less than 50 mm (2 in.) of concrete for the portion of the branch circuit between the branch-circuit overcurrent device and the first outlet, it shall be permitted to install an outlet branch-circuit type AFCI at the first outlet to provide protection for the remaining portion of the branch circuit.~~

~~**Exception No. 3:** Where an individual branch circuit to a fire alarm system installed in accordance with 760.41(B) or 760.121(B) is installed in RMC, IMC, EMT, or steel-sheathed cable, Type AC or Type MC, meeting the requirements of 250.118, with metal outlet and junction boxes, AFCI protection shall be permitted to be omitted.~~

~~**Informational Note No. 1:** For information on types of combination type and branch/feeder type arc-fault circuit interrupters, see UL 1699-1999, Standard for Arc-Fault Circuit-Interrupters. For information on outlet branch circuit type arc-fault circuit interrupters, see UL Subject 1699A Outline of Investigation for Outlet Branch Circuit Arc-Fault Circuit-Interrupters. For information on system combination AFCIs, see UL Subject 1699C Outline of Investigation for System Combination Arc-Fault Circuit Interrupters.~~

~~**Informational Note No. 2:** See 11.6.3(5) of NFPA 72-2010, National Fire Alarm and Signaling Code, for information related to secondary power supply requirements for smoke alarms installed in dwelling units.~~

~~**Informational Note No. 3:** See 760.41(B) and 760.121(B) for power-supply requirements for fire alarm systems.~~

Comments

AFCI protection was required for all 120-volt, single-phase, 15- and 20-ampere branch circuits supplying outlets installed in dwelling unit family rooms, dining rooms, living rooms, parlors, libraries, dens, bedrooms, sunrooms, recreation rooms, closets, hallways, or similar rooms or areas.

The requirement for AFCI protection was expanded to include kitchens and laundry areas. AFCI protection is now required for all 120-volt, single-phase, 15- and 20-ampere branch circuits supplying not just outlets but also devices installed in the list of areas requiring AFCI protection at 210.12(A).

Changed From NEC 2011

210.12 Arc-Fault Circuit-Interrupter Protection

(B) Branch Circuit Extensions or Modifications — Dwelling Units

Exception

Existing branch circuit conductors can be extended up to 1.8 m (6 ft.) without AFCI protection where no additional outlets or devices are installed for when modified or extended.

NEC Language

Arc-fault circuit-interrupter protection shall be provided as required in 210.12(A), (B), and (C). The arc-fault circuit interrupter shall be installed in a readily accessible location.

(B) Branch Circuit Extensions or Modifications — Dwelling Units

In any of the areas specified in 210.12(A), where branch-circuit wiring is modified, replaced, or extended, the branch circuit shall be protected by one of the following:

- (1) A listed combination-type AFCI located at the origin of the branch circuit, or
- (2) A listed outlet branch-circuit type AFCI located at the first receptacle outlet of the existing branch circuit.

Exception: AFCI protection shall not be required where the extension of the existing conductors is not more than 1.8 m (6 ft.) and does not include any additional outlets or devices.

Comments

210.12(B) now requires AFCI protection for branch-circuit wiring in areas of a dwelling unit specified at 210.12(A) when said wiring is modified, replaced, or extended.

This AFCI protection can be provided by a listed combination-type AFCI overcurrent device or a listed outlet branch-circuit (OBC) AFCI device located at the first receptacle outlet of the existing branch circuit.

A new exception to AFCI Branch Circuit Extensions or Modifications indicates what is considered a “dwelling unit branch circuit extension” and clarifies that branch circuit conductors can be extended up to 1.8 m (6 ft.) without AFCI protection where no additional outlets or devices are installed.

Changed From NEC 2011

210.12 Arc-Fault Circuit-Interrupter Protection

(C) Dormitory Units

Dormitory units will now require AFCI protection.

NEC Language

210.12 Arc-Fault Circuit-Interrupter Protection

Arc-fault circuit-interrupter protection shall be provided as required in 210.12(A),(B) and (C).

The arc-fault circuit interrupter shall be installed in a readily accessible location.

(C) Dormitory Units. All 120-volt, single-phase, 15- and 20-ampere branch circuits supplying outlets installed in dormitory unit bedrooms, living rooms, hallways, closets, and similar rooms

shall be protected by a listed arc-fault circuit interrupter meeting the requirements of 210.12(A)(1) through (6) as appropriate.

Comments

A new 210.12(C) requires all 120-volt, single-phase, 15- and 20-ampere branch circuits supplying outlets installed in dormitory unit bedrooms, living rooms, hallways, closets, and similar rooms to be provided with AFCI protection.

Many dormitories now closely resemble apartment buildings with suite style units that include a mini version of a kitchen. These facilities serve as dwelling units and the occupants should be afforded the same level of protection provided by AFCI protection as those who reside in a dwelling unit.

210.13 Ground Fault Protection of Equipment

GFP of equipment is now required for branch-circuit disconnects meeting provisions described at 230.95.

NEC Language

210.13 Ground Fault Protection of Equipment

Each branch-circuit disconnect rated 1000 amperes or more and installed on solidly grounded wye electrical systems of more than 150 volts to ground, but not exceeding 600 volts phase-to-phase, shall be provided with ground fault protection of equipment in accordance with the provisions of 230.95.

Informational Note: For buildings that contain health care occupancies, see the requirements of 517.17.

Exception No. 1: The provisions of this section shall not apply to a disconnecting means for a continuous industrial process where a nonorderly shutdown will introduce additional or increased hazards.

Exception No. 2: The provisions of this section shall not apply if ground-fault protection of equipment is provided on the supply side of the branch circuit and on the load side of any transformer supplying the branch circuit.

210.17 Electric Vehicle Branch Circuit

Outlet(s) installed for the purpose of charging electric vehicles are required to be supplied by a separate branch circuit with no other outlets.

NEC Language

210.17 Electric Vehicle Branch Circuit

Outlet(s) installed for the purpose of charging electric vehicles shall be supplied by a separate branch circuit. This circuit shall have no other outlets.

Informational Note. See 625.2 for the definition of “Electrical Vehicle”.

Comments

The NEC added new provisions that require outlet(s) installed for charging electric vehicles to be supplied by a separate branch circuit with no other outlets.

A new **Informational Note** was also added to point users of the Code to 625.2 for the definition of an electrical vehicle.

Charging an electric vehicle (EV) by simply plugging into an existing 120-volt receptacle outlet that is more than likely supplied from a general lighting circuit can and will overload this existing general purpose branch circuit.

Note that this new requirement does not demand that an outlet(s) for the specific and sole purpose of charging EV equipment be installed. This new requirement simply states that where such EV charging outlet(s) are installed (by choice), these outlet(s) must be supplied by a separate or individual branch circuit with no other outlets. This new provision for EV charging helps to ensure that EV charging can be completed safely and effectively without overloading an existing branch circuit.

210.52 Dwelling Unit Receptacle Outlets

(E)(1) & E(2)

The NEC revised the requirements for outdoor receptacles at dwellings to permit the required receptacle outlets to be “readily accessible from grade.”

NEC Language

210.52 Dwelling Unit Receptacle Outlets

(E) Outdoor Outlets. Outdoor receptacle outlets shall be installed in accordance with (E)(1) through (E)(3). [~~See 210.8(A)(3).~~]

Informational Note: See 210.8(A)(3).

(1) One-Family and Two-Family Dwellings. For a one-family dwelling and each unit of a two-family dwelling that is at grade level, at least one receptacle outlet readily accessible ~~while standing at~~ from grade level and located not more than 2.0 m (6 ½ ft) above grade level shall be installed at the front and back of the dwelling.

(2) Multifamily Dwellings. For each dwelling unit of a multifamily dwelling where the dwelling unit is located at grade level and provided with individual exterior entrance/egress, at least one receptacle outlet readily accessible from grade level and not more than 2.0 m (6 ½ ft) above grade level shall be installed.

Comments

This section requires at least two outdoor receptacles at every single-family dwelling, one at the front and one at the back. The parent language at 210.52 clarifies that these receptacle outlets are to be rated at 125-volt, 15-or 20-amperes. This rule also applies at every two-family dwelling that is accessible at grade level.

The NEC revised this provision for outdoor receptacles by removing the "while standing at grade level" requirement for one- and two-family dwellings.

The required outdoor receptacle outlet(s) was further revised by requiring these receptacle outlet(s) to be "readily accessible" rather than just "accessible" from grade level.

The required outdoor receptacle outlet(s) now has the same requirement to be "readily accessible from grade" at one-family, two-family, and multifamily dwelling units.

(E) Outdoor Outlets

(3) Balconies, Decks and Porches

The NEC revised the requirement for a receptacle located at "Balconies, Decks, and Porches" to require the balcony, deck or porch to be attached to the dwelling, and to eliminate the requirements for the outdoor receptacle outlet to be installed "within the perimeter of the balcony, deck or porch."

NEC Language

210.52 Dwelling Unit Receptacle Outlets

(E) Outdoor Outlets. Outdoor receptacle outlets shall be installed in accordance with (E)(1) through (E)(3). ~~{See 210.8(A)(3).}~~

Informational Note: See 210.8(A)(3).

(3) Balconies, Decks and Porches

Balconies, decks and porches that are attached to the dwelling unit and are accessible from inside the dwelling unit shall have at least one receptacle outlet installed ~~within the perimeter of~~

accessible from the balcony, deck or porch. The receptacle outlet shall not be located more than 2.0 m (6 ½ ft) above the balcony, deck, or porch walking surface.

Comments

All balconies, decks, and porches that are accessible from inside the dwelling unit are required to have at least one 125-volt, 15- or 20-ampere receptacle outlet installed within the perimeter of the balcony, deck, or porch. The receptacle cannot be located more than 2.0 m (6 ½ ft) above the balcony, deck, or porch surface.

The 2014 *NEC* clarified that this outdoor receptacle outlet requirement only applied to a balcony, deck or porch that is attached to the dwelling. Further revision to this requirement eliminated the requirements for the outdoor receptacle outlet(s) to be installed "within the perimeter of the balcony, deck or porch."

(G) Basements, Garages, and Accessory Buildings

The NEC revised into a list format receptacle provisions for basements, garages, and accessory buildings.

A branch circuit supplying garage receptacle(s) is to supply only the garage. Receptacles are required for each car space in a garage.

NEC Language

(G) Basements, Garages, and Accessory Buildings

For a one-family dwelling, ~~the following provisions shall apply:~~ at least one receptacle outlet shall be installed in the following specified areas. These receptacles shall be in addition to receptacles required for specific equipment.

(1) **Garages.** In each attached garage and in each detached garage with electric power. The branch circuit supplying this receptacle(s) shall not supply outlets outside of the garage. At least one receptacle outlet shall be installed for each car space.

(2) **Accessory Buildings.** In each accessory building with electric power.

(3) **Basements.** In each separate unfinished portion of a basement.

Comments

Receptacles are still required in the same locations at basements, garages, and accessory buildings as the 2011 NEC requirements, with revisions added to require the branch circuit(s) supplying garage receptacle(s) to supply only garage outlet(s). A receptacle is now required for each car space in a garage as well.

210.64 Electrical Service Areas

The NEC now requires installation of 125-volt, single-phase, 15- or 20-ampere receptacle outlets at electrical service areas.

NEC Language

210.64 Electrical Service Areas

At least one 125-volt, single-phase, 15- or 20-ampere-rated receptacle outlet shall be installed within 15 m (50 ft) of the electrical service equipment.

Exception: The receptacle outlet shall not be required to be installed in one- and two-family dwellings.

Comments

This new rule is similar to the requirement for a service receptacle outlet to be installed within 7.5 m (25 ft) of all heating, air-conditioning, and refrigeration equipment at 210.63.

At service equipment, there is sometimes a need for connecting portable electrical data acquisition equipment for the qualitative analysis of the electrical system. Test equipment is frequently needed for monitoring and servicing electrical equipment in service areas as well.

ARTICLE 220 Branch-Circuit, Feeder, and Service Calculations

220.3 Application of Other Articles

In other articles applying to the calculation of loads in specialized applications, there are requirements provided in Table 220.3 that are in addition to, or modifications of, those within this article.

Table 220.3 - Additional Load Calculation References (in part)

A new line item was added to Table 220.3 for "Electric Vehicle Charging Equipment" and a reference to 625.41. (Note that the reference shown in the published table is not correct).

NEC Language

Table 220.3 Additional Load Calculation References (in part)		
Calculation	Article	Section (or Part)
Air-conditioning and refrigerating equipment, branch-circuit conductor sizing	440	Part IV
Cranes and hoists, rating and size of conductors	610	610.14
Electric vehicle charging system branch circuit and feeder calculations	625	625.14
Electric welders, ampacity calculations	630	630.11, 630.31
Electrically driven or controlled irrigation machines	675	675.7(A), 675.22(A)
<i>(Remainder of table unchanged, see NEC for complete table)</i>		

Source: NEC 2014

Comments

New line item was added to Table 220.3, Additional Load Calculation References, is titled "Electric vehicle charging system branch circuit and feeder calculations" with a reference to 625.41 also added to this table.

220.12 Lighting Load for Specified Occupancies

Exception

The NEC added a new exception to "*Lighting Loads for Specified Occupancies*" that will permit lighting loads to be calculated in accordance with locally adopted energy codes where power monitoring systems are in place and the demand factors specified in 220.42 have not been applied to the general lighting load.

NEC Language

220.12 Lighting Load for Specified Occupancies

Exception

A unit load of not less than that specified in Table 220.12 for occupancies specified therein shall constitute the minimum lighting load. The floor area for each floor shall be calculated from the outside dimensions of the building, dwelling unit, or other area involved. For dwelling units, the calculated floor area shall not include open porches, garages, or unused or unfinished spaces not adaptable for future use.

Exception: Where the building is designed and constructed to comply with an energy code adopted by the local authority, the lighting load shall be permitted to be calculated at the values specified in the energy code where the following conditions are met:

- (1) A power monitoring system is installed that will provide continuous information regarding the total general lighting load of the building.
- (2) The power monitoring system will be set with alarm values to alert the building owner or manager if the lighting load exceeds the values set by the energy code.
- (3) The demand factors specified in 220.42 are not applied to the general lighting load.

Comments

This new exception recognizes that there are calculations in Article 220 that can be adjusted to align with model energy code mandates. The three conditions stipulated in the new exception are necessary to alert the owners and maintenance personnel that might be monitoring the system that the energy code calculations are about to, or have been, exceeded.

225.52 Disconnecting Means

(A) Location

A revision correlates location and operating requirements for outside branch circuit and feeder disconnecting means operating at over 1000 volts with that of service disconnecting means.

NEC Language

225.52 Disconnecting Means

(A) Location. A building or structure disconnecting means shall be located in accordance with 225.32, or, if not readily accessible, it shall be operable by mechanical linkage from a readily accessible point. For multibuilding industrial installations under single management, it shall be permitted to be electrically operated by a ~~similarly located~~, readily accessible remote-control device in a separate building or structure.

Comments

Section 225.52(A) applies to the location of the disconnecting means for an outside branch circuit of feeder.

Often, at campus-style industrial occupancies, a pole-mounted disconnect will be placed in an outdoor feeder location and not in service conductors supplied directly by the utility. The safety concerns for this type of feeder disconnecting means will be identical to those for a service disconnection means in Article 230.

ARTICLE 230 Services

230.30 Installation. (Underground Service Conductors)

Section 230.30 was divided into two sub-sections **(A) Insulation** and **(B) Wiring Methods**, and a list of acceptable wiring methods for underground service conductors was added.

NEC Language

230.30 ~~Insulation~~ Installation. (Underground Service Conductors)

(A) Insulation. Underground service-lateral conductors shall be insulated for the applied voltage.

Please see your copy of the NEC to review exceptions.

(B) Wiring Methods. Underground service conductors shall be installed in accordance with the applicable requirements of this Code covering the type of wiring method used and shall be limited to the following methods:

- (1) Type RMC conduit
- (2) Type IMC conduit
- (3) Type NUCC conduit
- (4) Type HDPE conduit
- (5) Type PVC conduit
- (6) Type RTRC conduit
- (7) Type IGS cable
- (8) Type USE conductors or cables
- (9) Type MV or Type MC cable identified for direct burial applications
- (10) Type MI cable, where suitably protected against physical damage and corrosive conditions.

Comments

The NEC added a new 230.30(B) to this section identifying a list of acceptable wiring methods permitted for underground service conductors.

The list includes all the cables and conductors that are identified in Chapter 3 as suitable for use as both service conductors and for direct burial.

230.44 Cable Trays

Cable trays containing service-entrance conductors are required to include warning labels, spaced at intervals not to exceed 3.0 m (10 ft).

NEC Language

230.44 Cable Trays

Cable tray systems shall be permitted to support service entrance conductors. Cable trays used to support service-entrance conductors shall contain only service-entrance conductors and shall be limited to the following methods:

- (1) Type SE cable
- (2) Type MC cable
- (3) Type MI cable
- (4) Type IGS cable
- (5) Single thermoplastic-insulated conductors 1/0 and larger with CT rating

Such cable trays shall be identified with permanently affixed labels with the wording "Service-Entrance Conductors." The labels shall be located so as to be visible after installation with a spacing not to exceed 3.0 m (10 ft) and placed so that the service entrance conductors are able to be readily traced through the entire length of the cable tray.

Exception: Conductors, other than service-entrance conductors, shall be permitted to be installed in a cable tray with service-entrance conductors, provided a solid fixed barrier of a material compatible with the cable tray is installed to separate the service-entrance conductors from other conductors installed in the cable tray.

Comments

This warning label spacing requirement will aid in the ability to trace the service-entrance conductors throughout the building.

230.82 Equipment Connected to the Supply Side of Service Disconnect

(3)

For “*Equipment Connected to the Supply Side of Service Disconnect*,” provisions for a meter disconnect switch were revised by adding a label requirement to indicate “METER DISCONNECT NOT SERVICE EQUIPMENT.”

NEC Language

230.82 Equipment Connected to the Supply Side of Service Disconnect

Only the following equipment shall be permitted to be connected to the supply side of the service disconnecting means:

- (1) Cable limiters or other current-limiting devices.
- (2) Meters and meter sockets nominally rated not in excess of ~~600~~ 1000 volts, provided that all metal housings and service enclosures are grounded in accordance with Part VII and bonded in accordance with Part V of Article 250.
- (3) Meter disconnect switches nominally rated not in excess of ~~600~~ 1000 volts that have a short-circuit current rating equal to or greater than the available short-circuit current, provided all metal housings and service enclosures are grounded in accordance with Part VII and bonded in accordance with Part V of Article 250.

A meter disconnect switch shall be capable of interrupting the load served. A meter disconnect shall be legibly field marked on its exterior in a manner suitable for the environment as follows:

METER DISCONNECT NOT SERVICE EQUIPMENT.

(The remainder of the text is unchanged.)

Please see your copy of the NEC for the complete text.

Comments

A meter disconnect switch is not the service disconnecting means. It is a simple load-breaking disconnect switch, sometimes located inside the meter socket enclosure, designed to interrupt or remove the load from the meter socket for the purpose of removing or changing the glass (some are now plastic) meter, maintenance, etc.

Potential hazardous arcing can exist when attempting to change out a meter when the voltage involved exceeds 150 volts to ground, thus the need for a meter disconnect switch.

Because this meter switch is used to remove the load from the meter socket, it is required to have a short-circuit current rating equal to or greater than the available short-circuit current.

Due in part to this equipment rating, meter disconnect switches are often times confused with the service disconnecting means.

ARTICLE 240 Overcurrent Protection

240.21 Location in Circuit

(B) Feeder Taps

(1) Taps Not over 3 m (10 ft) Long

Tap conductor Ampacity for feeder taps not over 3 m (10 ft) long is to be not less than the rating of the equipment containing an overcurrent device(s).

NEC Language

240.21 Location in Circuit

Overcurrent protection shall be provided in each ungrounded circuit conductor and shall be located at the point where the conductors receive their supply except as specified in 240.21(A) through (H). Conductors supplied under the provisions of 240.21(A) through (H) shall not supply another conductor except through an overcurrent protective device meeting the requirements of 240.4.

(B) Feeder Taps. Conductors shall be permitted to be tapped, without overcurrent protection at the tap, to a feeder as specified in 240.21(B)(1) through (B)(5). The provisions of 240.4(B) shall not be permitted for tap conductors.

(1) Taps Not over 3 m (10 ft) Long. If the length of the tap conductors does not exceed 3 m (10 ft) and the tap conductors comply with all of the following:

(1) The ampacity of the tap conductors is

a. Not less than the combined calculated loads on the circuits supplied by the tap conductors, and

240.21 b. Not less than the rating of the equipment containing an overcurrent device(s) supplied by the tap conductors or not less than the rating of the overcurrent protective device at the termination of the tap conductors.

Exception to b.: Where listed equipment, such as surge protective device(s) (SPDs), are provided with specific instructions on minimum conductor sizing, the ampacity of the tap conductors supplying that equipment shall be permitted to be determined based on the manufacturer's instructions.

(Please use your copy of the NEC for the remainder of Code text)

240.87 Arc Energy Reduction

The NEC changed the title to "*Arc Energy Reduction*" and revised the section for usability and formatted it into subdivisions.

NEC Language

240.87 ~~Noninstantaneous-Trip~~ Arc Energy Reduction

~~Where a circuit breaker is used without an instantaneous trip,~~ Where the highest continuous current trip setting for which the actual overcurrent device installed in a circuit breaker is rated or can be adjusted is 1200 amperes or higher then 240.87(A) and (B) shall apply.

(A) Documentation. Documentation shall be available to those authorized to design, install, operate, or inspect the installation as to the location of the circuit breaker(s).

(B) Method to Reduce Clearing Time. ~~Where a circuit breaker is utilized without an instantaneous trip,~~ One of the following or approved equivalent means shall be provided:

- (1) Zone-selective interlocking
- (2) Differential relaying
- (3) Energy-reducing maintenance switching with local status indicator
- (4) Energy-reducing active arcflash mitigation system
- (5) An approved equivalent means

Informational Note No. 1: An energy-reducing maintenance switch allows a worker to set a circuit breaker trip unit to "no intentional delay" to reduce the clearing time while the worker is working within an arc-flash boundary as defined in NFPA 70E-2012, Standard for Electrical Safety in the Workplace, and then to set the trip unit back to a normal setting after the potentially hazardous work is complete.

Informational Note No. 2: An energy reducing active arc-flash mitigation system helps in reducing arcing duration in the electrical distribution system. No change in circuit breaker or the settings of other devices is required during maintenance when a worker is working within an arc-flash boundary as defined in NFPA 70E-2012, Standard for Electrical Safety in the Workplace.

Comments

This title change better reflects the purpose for this code rule, and the entire section was revised for usability and formatted into subdivisions.

The revision clarifies that this rule applies only to circuit breakers that are intentionally delayed under short-circuit conditions, and that these circuit breakers do not have an instantaneous trip setting. They also do not have an override setting higher than the potential arc current.

Changes in the 2014 National Electrical Code (NEC®): Chapter 2 — Wiring and Protection

The NEC also added a limitation to the size of breaker (1200 ampere) required to comply with this section. Two additional methods for reducing arc energy were added to the list of methods as well.

ARTICLE 250 Grounding and Bonding

250.8 Connection of Grounding and Bonding Equipment

(A) Permitted Methods

The permitted methods for connecting equipment grounding conductors, bonding jumpers, etc., to such things as enclosures were expanded to one "or more" of the methods described at 250.8(A).

NEC Language

250.8 Connection of Grounding and Bonding Equipment.

(A) Permitted Methods. Equipment grounding conductors, grounding electrode conductors, and bonding jumpers shall be connected by one or more of the following means:

- (1) Listed pressure connectors
- (2) Terminal bars
- (3) Pressure connectors listed as grounding and bonding equipment
- (4) Exothermic welding process
- (5) Machine screw-type fasteners that engage not less than two threads or are secured with a nut
- (6) Thread-forming machine screws that engage not less than two threads in the enclosure
- (7) Connections that are part of a listed assembly
- (8) Other listed means

Comments

Equipment grounding conductors, grounding electrode conductors, and bonding jumpers were required to be connected by "one" of the eight methods described at 250.8(A).

The revision of 250.8(A) permits one "or more" of the eight methods described in this subsection for connection of equipment grounding conductors, grounding electrode conductors, and bonding jumpers.

250.21 Alternating-Current Systems of 50 Volts to Less Than 1000 Volts Not Required to Be Grounded

(C) Marking

Ungrounded systems are to be legibly marked

“Caution Ungrounded System Operating — ____ Volts Between Conductors.”

NEC Language

250.21 Alternating-Current Systems of 50 Volts to Less Than 1000 Volts Not Required to Be Grounded

(C) Marking

Ungrounded systems are to be legibly marked “Caution Ungrounded System Operating — ____ Volts Between Conductors.” at the source or first disconnecting means of the system. The marking shall be of sufficient durability to withstand the environment involved.

Comments

The NEC changed the marking requirement for an ungrounded system in Article 250 to “*Caution Ungrounded System Operating — ____ Volts Between Conductors*” to coincide with similar provisions at 408.3(F)(2) for a switchboard, switchgear, or panelboard.

250.24 Grounding Service Supplied Alternating-Current Systems

(A) System Grounding Connections

(1) General

The NEC added references to overhead service conductors and underground service conductors to sections where needed in Article 250.

NEC Language

250.24 Grounding Service Supplied Alternating-Current Systems

(A) System Grounding Connections. A premises wiring system supplied by a grounded ac service shall have a grounding electrode conductor connected to the grounded service conductor, at each service, in accordance with 250.24(A)(1) through (A)(5).

(1) General. The grounding electrode conductor connection shall be made at any accessible point from the load end of the overhead service conductors, service drop, underground service conductors, or service lateral to and including the terminal or bus to which the grounded service conductor is connected at the service disconnecting means.

Informational Note: See definitions of Service Conductors, Overhead; Service Conductors, Underground; Service Drop; and Service Lateral in Article 100.

Comments

The terms *overhead service conductor* and *underground service conductor* were added with definitions to Article 100 in the 2011 NEC, and used throughout Article 230 for service requirements. These terms were inadvertently omitted from Article 250 and needed to be added for proper application of these defined terms and their requirements.

250.64 Grounding Electrode Conductor Installation

(B) Securing and Protection Against Physical Damage

The NEC added new provisions to clarify that grounding electrode conductors and grounding electrode bonding jumpers are not required to comply with 300.5 for underground installations.

NEC Language

250.64 Grounding Electrode Conductor Installation

Grounding electrode conductors at the service, at each building or structure where supplied by a feeder(s) or branch circuit(s), or at a separately derived system shall be installed as specified in 250.64(A) through (F).

(B) Securing and Protection Against Physical Damage. Where exposed, a grounding electrode conductor or its enclosure shall be securely fastened to the surface on which it is carried.

Grounding electrode conductors shall be permitted to be installed on or through framing members.

A 4 AWG or larger copper or aluminum grounding electrode conductor shall be protected if exposed to physical damage.

A 6 AWG grounding electrode conductor that is free from exposure to physical damage shall be permitted to be run along the surface of the building construction without metal covering or protection if it is securely fastened to the construction; otherwise, it shall be protected in rigid metal conduit (RMC), intermediate metal conduit (IMC), rigid polyvinyl chloride conduit (PVC), reinforced thermosetting resin conduit (RTRC), electrical metallic tubing (EMT), or cable armor. Grounding electrode conductors smaller than 6 AWG shall be protected in RMC, IMC, PVC, RTRC, EMT, or cable armor. Grounding electrode conductors and grounding electrode bonding jumpers shall not be required to comply with 300.5.

Comments

Prior to this clarification concerning grounding electrode conductors and burial depth requirements of Table 300.5, the Code was unclear on this subject.

Due to inconsistent interpretation, some users of the Code would enforce or apply 300.5 burial depth requirements to grounding electrode conductors while others did not.

Some enforcers of the Code would require grounding electrode conductors or grounding electrode bonding jumpers to be installed under the provisions of Column 1 of Table 300.5, which is for "Direct Buried Cables or Conductors." This added sentence at 250.64(B) will clarify that grounding electrode conductors or grounding electrode bonding jumpers are not subject to the burial depth requirements of 300.5 or Table 300.5.

In some cases, installing the grounding electrode conductor to comply with Table 300.5 would require the grounding electrode conductor to be routed down an exterior wall of a building, offset to the burial depth, and then back up to be connected to a grounding electrode that might be installed close to the foundation wall. This could introduce sharp bends in the grounding electrode conductor that could decrease the effectiveness of this grounding electrode to dissipate over currents into the earth.

(D) Building or Structure with Multiple Disconnecting Means in Separate Enclosures

(1) Common Grounding Electrode Conductor and Taps

The NEC revised “**Common Grounding Electrode Conductor and Taps**” to address busbar specifications and where buildings or structures are supplied by a feeder or a service.

NEC Language

250.64 Grounding Electrode Conductor Installation

Grounding electrode conductors at the service, at each building or structure where supplied by a feeder(s) or branch circuit(s), or at a separately derived system shall be installed as specified in 250.64(A) through (F).

(D) - Service Building or Structure with Multiple Disconnecting Means in Separate Enclosures.

~~If a service consists of more than a single enclosure as permitted in 230.71(A), or feeder with two or more disconnecting means in separate enclosures supplying a building or structure, the grounding electrode connections shall be made in accordance with 250.64(D)(1), (D)(2), or (D)(3).~~

(1) Common Grounding Electrode Conductor and Taps. A common grounding electrode conductor and grounding electrode conductor taps shall be installed. The common grounding electrode conductor shall be sized in accordance with 250.66, based on the sum of the circular mil area of the largest ungrounded ~~service-entrance conductor(s)~~ of each set of conductors that supply the disconnecting means. If the service-entrance conductors connect directly to overhead service conductors, a service drop, underground service conductors, or service lateral, the common grounding electrode conductor shall be sized in accordance with Table 250.66, Note 1.

A grounding electrode conductor tap shall extend to the inside of each ~~service~~ disconnecting means enclosure. The grounding electrode conductor taps shall be sized in accordance with 250.66 for the largest service-entrance or feeder conductor serving the individual enclosure. The tap conductors shall be connected to the common grounding electrode conductor by one of the following methods in such a manner that the common grounding electrode conductor remains without a splice or joint:

- (1) Exothermic welding.
- (2) Connectors listed as grounding and bonding equipment.
- (3) Connections to an aluminum or copper busbar not less than 6 mm thick × 50 mm wide (¼ in. thick × 2 in. wide) and of sufficient length to accommodate the number of terminations necessary for the installation. The busbar shall be securely fastened and shall be installed in an accessible location. Connections shall be made by a listed connector or by the exothermic welding process. *If aluminum busbars are used, the installation shall comply with 250.64(A).*

Comments

The parent text at 250.64 indicates that this section is intended to cover the installation of grounding electrode conductor(s) at services or buildings or structures where supplied by feeder(s) or branch circuit(s).

However, 250.64(D) in previous editions of the Code indicated that the installation of grounding electrode conductors with multiple disconnecting means only applied to buildings supplied by a service, and no language existed for buildings or structures supplied by feeders. Revisions in

the 2014 NEC elucidates that these provisions for grounding electrode conductor(s) connections apply to building or structures supplied by feeders or services.

Revisions to 250.64(D)(1) clarify that this common grounding electrode conductor busbar is a separate busbar and not an accessory terminal bar provided for a panelboard.

This accessory terminal bar provided for a panelboard is not a busbar; it is terminal bar as noted.

Revisions to this section add the requirement that the common grounding electrode conductor busbar be of sufficient length to connect all grounding electrode conductors and/or bonding jumpers or conductors that must be attached.

(E) Raceways and Enclosures for Grounding Electrode Conductors

Requirements for raceways and enclosures for grounding electrode conductors are broken into four (4) list items for clarity.

NEC Language

250.64 Grounding Electrode Conductor Installation

(E) Raceways and Enclosures for Grounding Electrode Conductors

(1) General. Ferrous metal raceways and enclosures for grounding electrode conductors shall be electrically continuous from the point of attachment to cabinets or equipment to the grounding electrode and shall be securely fastened to the ground clamp or fitting. Ferrous metal raceways and enclosures ~~that are not physically continuous from cabinets or equipment to the grounding electrode shall be made electrically continuous by bonding~~ bonded at each end of the raceway or enclosure to the grounding electrode or grounding electrode conductor.

Nonferrous metal raceways and enclosures shall not be required to be electrically continuous.

(2) Methods. Bonding ~~methods shall be in compliance with 250.92(B) for installations at service equipment locations and with~~ ensured by one of the methods in 250.92(B)(2) through (B)(4) ~~for other than service equipment locations shall apply at each end and to all intervening ferrous raceways, boxes, and enclosures between the cabinets or equipment and the grounding electrode.~~

(3) Size. No Change

(4) Wiring Methods. No Change.

Please see your copy of the NEC for the complete text.

Comments

The revisions to 250.64(E) were intended to be editorial in nature, including breaking up a long single-paragraph Level 1 subsection into list items and providing titles for the list items. There were not any technical changes to these provisions.

Language was also added to incorporate provisions for ferrous metal raceways, not just ferrous metal enclosures.

250.66 Size of Alternating Current Grounding Electrode Conductor

(A) Connections to a Rod, Pipe, or Plate Electrode(s)

(B) Connections to Concrete-Encased Electrode(s)

Clarification to the term *sole connection* makes it clear that this sole connection is related to the grounding electrode conductor itself and not to the number of specified electrode(s) involved.

NEC Language

250.66 Size of Alternating Current Grounding Electrode Conductor

The size of the grounding electrode conductor at the service, at each building or structure where supplied by a feeder(s) or branch circuit(s), or at a separately derived system of a grounded or ungrounded ac system shall not be less than given in Table 250.66, except as permitted in 250.66(A) through (C).

~~**Informational Note:** See 250.24(C) for size of ac system conductor brought to service equipment.~~

(A) Connections to a Rod, Pipe, or Plate Electrode(s). Where the grounding electrode conductor is connected to a single or multiple rod, pipe, or plate electrode(s), or any combination thereof as permitted in 250.52(A)(5) or (A) (7), that portion of the conductor that is the sole connection to the grounding electrode(s) shall not be required to be larger than 6 AWG copper wire or 4 WG aluminum wire.

(B) Connections to Concrete-Encased Electrode(s). Where the grounding electrode conductor is connected to a single or multiple concrete-encased electrode(s) as permitted in 250.52(A)(3), that portion of the conductor that is the sole connection to the grounding electrode(s) shall not be required to be larger than 4 AWG copper wire

Comments

The revised language at 250.66(A) and (B) is an attempt to clarify that the sole connection sizing provisions for grounding electrode conductors to rod, pipe, plate, and concrete-encased electrodes are still relevant, even if more than one of these types of electrodes are installed or are present at a building or structure.

This revision should make it clear that if a grounding electrode conductor is installed to multiple concrete-encased electrodes connected together with a bonding jumper(s), the maximum size grounding electrode conductor to the first concrete-encased electrode or any bonding jumper(s) between the multiple concrete-encased electrodes is not required to be larger than a 4 AWG copper conductor.

250.68 Grounding Electrode Conductor and Bonding Jumper Connection to Grounding Electrodes

Changed From NEC 2011

(C) Grounding Electrode Connections

(2) and (3).

The NEC revised provisions for metal structure steel used as a conductor to interconnect electrodes.

The title of 250.68(C) was changed to "*Grounding Electrode Connections.*"

An extension from a concrete-encased electrode has been recognized for connection of grounding electrode conductors.

NEC Language

250.68 Grounding Electrode Conductor and Bonding Jumper Connection to Grounding Electrodes

The connection of a grounding electrode conductor at the service, at each building or structure where supplied by a feeder(s) or branch circuit(s), or at a separately derived system and associated bonding jumper(s) shall be made as specified 250.68(A) through (C).

(C) ~~Metallic Water Pipe and Structural Metal~~ Grounding Electrode Connections

Grounding electrode conductors and bonding jumpers shall be permitted to be connected at the following locations and used to extend the connection to an electrode(s):

(1) Interior metal water piping located not more than 1.52 m (5 ft) from the point of entrance to the building... (remainder of text and exception unchanged from 2011 text).

(2) ~~The metal structural frame of a building that is directly connected to a grounding electrode as specified in 250.52(A)(2) or 250.68(C) (2)(a), (b), or (c) shall be permitted to be used as a bonding conductor to interconnect electrodes that are part of the grounding electrode system, or as a grounding electrode conductor.~~

a. By connecting the structural metal frame to the reinforcing bars of a concrete-encased electrode, as provided in 250.52(A)(3), or ground ring as provided in 250.52(A)(4)

b. By bonding the structural metal frame to one or more of the grounding electrodes, as specified in 250.52(A)(5) or (A)(7), that comply with 250.53(A)(2)

c. By other approved means of establishing a connection to earth

(3) A concrete-encased electrode of either the conductor type, reinforcing rod or bar installed in accordance with 250.52(A)(3) extended from its location within the concrete to an accessible location above the concrete shall be permitted.

Comments

The metal structural frame of a building is still permitted as a means of interconnecting electrodes that are part of the grounding electrode system, but the prescriptive language was removed.

The NEC makes it clear that the structural metal frame of a building can be used to interconnect electrodes that are part of the grounding electrode system and should be treated the same as a metallic water piping system without having to meet qualifying conditions of a grounding electrode.

Changes in the 2014 National Electrical Code (NEC®): Chapter 2 — Wiring and Protection

The parent text at 250.68(C) makes it clear that structural metal can be used to connect wire type bonding jumpers or grounding electrode conductors to the structural metal as an extension of the wire type bonding conductors or grounding electrode conductors.

250.102 Bonding Conductors and Jumpers

(C) Size — Supply-Side Bonding Jumper.

(1) Size for Supply Conductors in a Single Raceway or Cable

Table 250.102(C)(1)

A new Table 250.102(C) (1) was added to be used for sizing grounded conductors, main bonding jumpers, system-bonding jumpers, and supply-side bonding jumpers, rather than Table 250.66.

NEC Language

250.102 Bonding Conductors and Jumpers

(C) Size — Supply-Side Bonding Jumper.

(1) Size for Supply Conductors in a Single Raceway or Cable

The supply-side bonding jumper shall not be smaller than specified in Table 250.66 Table 250.102(C)(1) for grounding electrode conductors. Where the ungrounded supply conductors are larger than 1100 kcmil copper or 1750 kcmil aluminum, the supply-side bonding jumper shall have an area not less than 12 1/2 percent of the area of the largest set of ungrounded supply conductors.

Table 250.102(C)(1) Grounded Conductor, Main Bonding Jumper, System Bonding Jumper, and Supply-Side Bonding Jumper for Alternating-Current Systems			
Size of Largest Ungrounded Conductor or Equivalent Area for Parallel Conductors (AWG/kcmil)		Size of Grounded Conductor or Bonding Jumper* (AWG/kcmil)	
Copper	Aluminum or Copper-Clad Aluminum	Copper	Aluminum or Copper-Clad Aluminum
2 or smaller	1/0 or smaller	8	6
1 or 1/0	2/0 to 3/0	6	4
2/0 or 3/0	4/0 or 250	4	2
Over 3/0 through 350	Over 250 through 500	2	1/0
Over 350 through 600	Over 500 through 900	1/0	3/0
Over 600 through 1100	Over 900 through 1750	2/0	4/0
Over 1100	Over 1750	See Notes	

*For the purposes of this table, the term bonding jumper refers to main bonding jumpers, system bonding jumpers, and supply-side bonding jumpers.

Notes:

- If the ungrounded supply conductors are larger than 1100 kcmil copper or 1750 kcmil aluminum, the grounded conductor or bonding jumper shall have an area not less than 12 1/2 percent of the area of the largest ungrounded supply conductor or equivalent area for parallel supply conductors. The grounded conductor or bonding jumper shall not be required to be larger than the largest ungrounded conductor or set of ungrounded conductors.
- If the ungrounded supply conductors and the bonding jumper are of different materials (copper, aluminum or copper-clad aluminum), the minimum size of the grounded conductor or bonding jumper shall be based on the assumed use of ungrounded supply conductors of the same material as the grounded conductor or bonding jumper and will have an ampacity equivalent to that of the installed ungrounded supply conductors.
- If multiple sets of service-entrance conductors are used as permitted in 230.4(f), except for No. 2, or if multiple sets of ungrounded supply conductors are installed for a separately derived system, the equivalent size of the largest ungrounded supply conductors shall be determined by the largest sum of the areas of the corresponding conductors of each set.
- If there are no service-entrance conductors, the supply conductor size shall be determined by the equivalent size of the largest service-entrance conductor required for the load to be served.

Source: NEC 2014

Due to the size of this Table, you may need to use your copy of the NEC.

(2) Size for Parallel Conductor Installations in Two or More Raceways

Where the ungrounded supply conductors are paralleled in two or more raceways or cables, and an individual supply-side bonding jumper is used for bonding these raceways or cables, the size of the supply-side bonding jumper for each raceway or cable shall be selected from ~~Table 250.66~~ Table 250.102(C)(1) based on the size of the ungrounded supply conductors in each raceway or cable. A single supply-side bonding jumper installed for bonding two or more raceways or cables shall be sized in accordance with 250.102(C)(1).

Informational Note No. 1: The term supply conductors includes ungrounded conductors that do not have overcurrent protection on their supply side and terminate at service equipment or the first disconnecting means of a separately derived system.

Informational Note No. 2: See Chapter 9, Table 8, for the circular mil area of conductors 18 AWG through 4/0 AWG.

Comments

The NEC added an *Informational Note* after 250.102(C)(2) to inform users of the Code what is intended by the term *supply conductors* as it is not defined in Article 100 or in 250.2.

250.122 Size of Equipment Grounding Conductors

(B) Increased in Size

Wire-type equipment grounding conductors are required to be increased in size when the minimum sized ungrounded conductors are increased in size.

NEC Language

250.122 Size of Equipment Grounding Conductors

(B) Increased in Size. Where ungrounded conductors are increased in size from the minimum size that has sufficient ampacity for the intended installation, wire-type equipment grounding conductors, where installed, shall be increased in size proportionately according to the circular mil area of the ungrounded conductors.

Comments

The NEC made revisions to 250.122(B) to specify that the equipment grounding conductors are required to be increased in size whenever the ungrounded conductors are increased in size are limited to wire-type equipment grounding conductors only.

Further revision indicates that the equipment grounding conductors are not required to be increased in size when the ungrounded conductors are already installed oversized or above the minimum sizes required for sufficient Ampacity for the intended load.

250.130 Equipment Grounding Conductor Connections

(C) Non-grounding Receptacle Replacement or Branch Circuit Extensions

(4)

Connection to an equipment grounding conductor that is part of another branch circuit that originates from the enclosure where the branch circuit for the receptacle or branch circuit originates is permitted for replacement of non-grounding-type receptacles with grounding-type receptacles and for branch-circuit extensions.

NEC Language

250.130 Equipment Grounding Conductor Connections

(C) Non-grounding Receptacle Replacement or Branch Circuit Extensions

The equipment grounding conductor of a grounding-type receptacle or a branch circuit extension shall be permitted to be connected to any of the following: [List items (1)-(3) and (5) and (6) remain unchanged.]

Please use your copy of the see NEC for the complete text.

(4) - An equipment grounding conductor that is part of another branch circuit that originates from the enclosure where the branch circuit for the receptacle or branch circuit originates.

Informational Note: See 406.4(D) for the use of a ground-fault circuit-interrupting type of receptacle.

250.166 Size of the Direct-Current Grounding Electrode Conductor

The NEC added a maximum size requirement for grounding electrode conductor of dc systems.

NEC Language

250.166 Size of the Direct Current Grounding Electrode Conductor

The size of the grounding electrode conductor for a dc system shall be as specified in 250.166(A) and (B), except as permitted by 250.166(C) through (E). The grounding electrode conductor for a dc system shall meet the sizing requirements in this section but shall not be required to be larger than 3/0 copper or 250 kcmil aluminum.

(The remainder of text at 250.166(A) through (E) is unchanged. See NEC for complete text.)

Comments

The NEC added a maximum size requirement of 3/0 copper or 250 kcmil aluminum for grounding electrode conductor of dc systems at 250.166.

This correlates with the maximum size requirements for ac system grounding electrode conductor as specified at 250.66 and Table 250.66.

250.167 Direct-Current Ground-Fault Detection

The NEC added a section requiring ground-fault detection on dc systems to “*Direct-Current Ground-Fault Detection*.” These new requirements address grounded systems, ungrounded systems, and marking rules for each.

NEC Language

250.167 Direct-Current Ground-Fault Detection

(A) Ungrounded Systems

Ground-fault detection systems shall be required for ungrounded systems.

(B) Grounded Systems

Ground-fault detection shall be permitted for grounded systems.

(C) Marking

Direct-current systems shall be legibly marked to indicate the grounding type at the dc source or the first disconnecting means of the system. The marking shall be of sufficient durability to withstand the environment involved.

Informational Note: NFPA 70E-2012 identifies four dc grounding types in detail.

250.186 Ground-Fault Circuit Conductor Brought to Service Equipment

The NEC added a new section for “*Ground Fault Circuit Conductor Brought to Service Equipment*” to require services over 1000 volts to have a grounded conductor to be brought to the service for a grounded system.

Ungrounded systems (over 1000 volts) will require a supply side bonding jumper brought to the service.

NEC Language

250.186 Ground-Fault Circuit Conductor Brought to Service Equipment

(A) Systems with a Grounded Conductor at the Service Point.

- (1) Sizing for a Single Raceway or Overhead Conductor.
- (2) Parallel Conductors in Two or More Raceways or Overhead Conductors.
- (3) Delta-Connected Service.
- (4) Impedance Grounded Neutral Systems.

(B) Systems without a Grounded Conductor at the Service Point.

- (1) Sizing for a Single Raceway or Overhead Conductor.
- (2) Parallel Conductors in Two or More Raceways or Overhead Conductors.
- (3) Impedance Grounded Neutral Systems. Impedance grounded neutral systems shall be installed in accordance with 250.187.

Please see your copy of the 2014 NEC for the complete text.

250.194 Grounding and Bonding of Fences and Other Metal Structures

The NEC added a section for bonding and grounding metal fences and other metal structures around substations.

NEC Language

250.194 Grounding and Bonding of Fences and Other Metal Structures

Metallic fences enclosing, and other metal structures in or surrounding, a substation with exposed electrical conductors and equipment shall be grounded and bonded to limit step, touch, and transfer voltages.

(A) Metal Fences. Where metal fences are located within 5 m (16 ft) of the exposed electrical conductors or equipment, the fence shall be bonded to the grounding electrode system with wire-type bonding jumpers as follows:

- (1) Bonding jumpers shall be installed at each fence corner and at maximum 50 m (160 ft) intervals along the fence.
- (2) Where bare overhead conductors cross the fence, bonding jumpers shall be installed on each side of the crossing.
- (3) Gates shall be bonded to the gate support post, and each gate support post shall be bonded to the grounding electrode system.
- (4) Any gate or other opening in the fence shall be bonded across the opening by a buried bonding jumper.
- (5) The grounding grid or grounding electrode systems shall be extended to cover the swing of all gates.
- (6) The barbed wire strands above the fence shall be bonded to the grounding electrode system.

Alternate designs performed under engineering supervision shall be permitted for grounding or bonding of metal fences.

Informational Note No. 1: A non-conducting fence or section may provide isolation for transfer of voltage to other areas.

Informational Note No. 2: See IEEE 80-2000, IEEE Guide for Safety in AC Substation Grounding, for design and installation of fence grounding.

(B) Metal Structures. All exposed conductive metal structures, including guy wires within 2.5 m (8 ft) vertically or 5 m (16 ft) horizontally of exposed conductors or equipment and subject to contact by persons, shall be bonded to the grounding electrode systems in the area.

Comments

Metal fences are often built around substations for reasons of security and economics.

Due to the fact that these fences will be accessible to the general public, they must be grounded to limit the rise of hazardous voltage potential on the fence to the surrounding earth.

This new provision in Part X of Article 250, *Grounding of Systems and Circuits of over 1000 Volts*, establishes basic prescriptive requirements for grounding and bonding of metal fences and metal structures built in and around substations.

Changes in the 2014 National Electrical Code (NEC®): Chapter 2 — Wiring and Protection

For situations where step and touch voltage potential considerations indicate that additional grounding and bonding design is necessary, alternate designs performed under engineering supervision are permitted.

Informational Note No. 2 directs designers to the industry standard on the grounding of fences in and around substations (*IEEE 80-2000, Guide for Safety in AC Substation Grounding*).

ARTICLE 285 Surge-Protective Devices (SPDs), 1000 Volts or Less

285.13 Type 4 and Other Component Type SPDs

Type 4 component assemblies and Type 5 SPDs (*Surge Protective device (s)*) are incomplete devices that are only acceptable when provided as part of listed equipment.

NEC Language

285.13 Type 4 and Other Component Type SPDs

Type 4 component assemblies and other component type SPDs shall only be installed by the equipment manufacturer.

Comments

This new section makes clear that component SPD(s) (*Surge Protective device (s)*) are not to be installed in the field.

Type 2 are typically connected on the load side of the service disconnecting means serving a branch circuit and protects against residual lightning energy, motor driven surges, and other internally generated surges.

Type 3 SPDs are generally surge receptacles or cord-connected point-of-use devices. They are permitted to be installed anywhere on the load side of a branch circuit up to the equipment served. Type 3 STPs are typically used to protect equipment and to provide point-of-use protection; they are easily replaceable and provide the last line of defense against a lightning strike.

Type 4 SPDs are UL Recognized Components. They are typically component assemblies consisting of one or more component-type STPs together with a disconnect (integral or external). Type 4 STPs are designated equipment that is installed within other listed equipment denoted as recognized component equipment.

Type 4 component assemblies and component-type SPDs are incomplete devices that are only acceptable when provided as part of listed equipment. This section clarifies that component SPD(s) are not to be installed in the field.

Conclusion

Summary

You have completed Chapter 2 of this course on *Changes in the 2014 NEC*.

Resources

References

1. National Fire Protection Association, Inc. Quincy, MA. *2014 National Electrical Code (NEC)*, 2013
2. International Association of Electrical Inspectors, Richardson, Texas and National Fire Protection Association, Inc. Quincy, MA. *Analysis of Changes – NEC 2014*. 2013

The designations "National Electrical Code" and "NEC" refer to NFPA 70, National Electrical Code, which is a registered trademark of the National Fire Protection Association.

Author Biography

Neal L. Burdick

Neal Burdick has over 30 years of experience and is currently a Construction Inspector for the City of Tampa. He is a registered instructor for the Electrical Council of Florida and is the author and instructor of a State of Florida approved Electrical Contractor's Licensing Board course.

Neal is an accomplished and exceptionally knowledgeable professional with a solid background in electrical and building inspections, as well as code compliance. He is recognized as an expert in this industry. He is an active member of IAEI, BOAF, ECF, and related industry associations. Mr. Burdick conducts training to Building Officials, Engineers, Plans Examiners, Inspectors, Electrical Contractors, and Apprentices throughout the State of Florida.

Attachment #2: Instructor Information

Course Instructor:

Neal Burdick

Florida Certified Electrical Contractor EC# 0002179

Mr. Burdick's resume is attached for review.

Neal L. Burdick
9840 Mainlands Blvd. West, Pinellas Park, FL 33782
Phone: 813-446-9848

PROFESSIONAL WORK HISTORY

CITY OF TAMPA, Tampa, FL 2005 – March 2013

Electrical / Construction Inspector II

Inspect all phases of electrical installations (residential, commercial, and industrial) permitted with the City of Tampa, to include underground, rough-in, and final inspections. Retrieve inspection requests, plan, and schedule, perform, and document an average of 18 to 25 field inspections daily. Verify on - site permit documentation and examine blueprints to ensure compliance with NEC and Florida Building Code requirements. Collaborate with contractors to identify and correct existing and potential deficiencies. Trained Building Inspectors on electrical segment of One / Two Family Dwelling Electrical Inspector examination; successfully tutored four Inspectors to secure their licenses.

CERTIFIED TEACHING / INSTRUCTION

PINELLAS COUNTY SCHOOL BOARD, Largo, FL 2011 - Present

Adult Education Trade Instructor (Tuesday / Thursday nights)

4th - year apprenticeship instructor for Bay Area Electrical Apprenticeship Program at Pinellas Technical Education Center (pTEC) Clearwater campus. Create lesson plans, curriculum, quizzes, and tests in preparation for the Electrical Journeyman Exam.

- Selected as keynote speaker for graduation banquet (2012).

BUILDING OFFICIALS ASSOCIATION OF FLORIDA, Lake Mary, FL 2009 – June 2012

Contract Instructor (volunteer)

Create and conduct Florida State - approved CEU classes for Building Officials, Plans Examiners, Engineers, Inspectors, and Contractors; class sizes range from 35 - 100 participants. Provide instruction at Chapter and Conference seminars throughout Florida; course topics include *Ethics in Construction*, *Photovoltaics*, and *National Electrical Code Updates*.

ELECTRICAL COUNCIL OF FLORIDA, Tampa, FL 2004 - Present

CEU Instructor/ Current Tampa Chapter President

Create and conduct Florida State - approved CEU code update classes throughout the state of Florida. Topics include: *Ethics in Construction*, *Prevention of False Alarms*, *Areas of Accessibility*, *Standby Generator Systems*, *National Electrical Code Updates*, *Laws & Rules for Construction Based on Florida Statutes*, and *Advanced Building Code Class*.

Instruct ECLB approved CEU classes to four local Chapters (4 - 6 times annually) and provide education at ECF State sponsored seminars (10 locations bi-annually); throughout the State of Florida.

- Certified through Construction Industry Licensing Board (CILB) and/or Electrical Contracting Licensing Board (ECLB) to conduct classes.

INDEPENDENT ELECTRICAL CONTRACTORS, Clearwater, FL 2006 - 2008

4th-Year Electrical Apprenticeship Instructor

Created lesson plans, quizzes, and exams.

- Lead 4th-year instructor; achieved 82% Journeymen Exam passing rate (27 students).

EDUCATION

Continuing Education Seminars and Code Update Classes through IAEI, BOAF and ECF

- *Network +* (2002); graduated in the Top 3 of Class.
- *AutoCAD for the Professional 3D Rendering; AutoCAD for the Professional Level I/II; AutoCAD 2002*
- Pinellas Vocational Technical Institute, Clearwater, FL; *Programmable Logical Controllers (1998)*
- *Motor Controls (1981)*
- *Charles J. Krasnoff Electrical Estimating Seminar*, Tampa, FL (1993)
- Bay Area Tech, Tampa, FL; *Electrical Estimating*
- *Masters Prep Course*
- Gibbs Sr. High School, St. Petersburg, FL; Diploma/Graduated

Attachment #3: Course Materials and Fees

Course Material:

The course is reviewed online and is available to anyone who purchases it 24/7 as long as there is computer and internet access.

All material necessary to complete the course is included by viewing online. Students are not directed to additional material as a requirement for course completion, only as added information for personal interest.

Course Fee:

The fee for this course is \$44.85

Attachment #4: Schedule of Course Dates and Locations

This course is presented in an online format. The course is available at www.RedVector.com 24 hours a day, 7 days a week to anyone with computer and internet access.

SAMPLE

Certificate of Completion

John Doe

VA License #: 123456

has successfully completed the following course

2014 NEC Changes - Introduction, Chapter 1 & Chapter 2 (RV-PGM101)

This online course is approved for 3 continuing education hours

XXXXXXXXXX

Course Approval



Matthew Casey, PhD, VP of Content

RedVector.com

AIA Registered Provider #J315

FL DBPR Approved Provider #0001771

FBPE Approved Provider #33

date of course completion

Course Completion Date



Two Urban Centre • 4890 West Kennedy Boulevard Suite 740 • Tampa, FL 33609

Attachment #6: Online/Correspondence Course Information

Security Procedures Utilized:

All students must register with the web site to gain access to their online course(s). The registration process creates a unique user profile and records their personal information including name, address, phone, email, username, password, licenses held, and license number(s). This information is automatically recorded and saved electronically.

We monitor required student participation in the course by logging and tracking the date and time a student enters a course, tracking activity during the course, and recording the date and time they complete the exam with a required passing score. If our learning management system detects 13-minutes of inactivity, a pop-up appears alerting the student that they must verify their presence or the session times out and the course closes.

In addition, at the completion of an exam, before it is graded, students are asked to confirm an affidavit indicating they personally completed the entire course. They must also confirm their identity before their exam is graded. This confirmation is stored in our database for audit purposes.

Once a student completes and passes the course with a grade of 70% or higher, they are given a certificate of completion and the course completion is recorded in their user profile, along with date and time completed.

End of Course Test:

A copy is attached for review.

Online Course Access:

The Board has been set up with a test account to preview courses on the RedVector.com website. To access the courses, please follow the directions below.

1. Log on to the web site at <http://www.RedVector.com>
2. On the top center of the page click the orange "Sign-In" button.
3. In the gray column labeled "Returning Users" enter your username **VAELEC** and your password **vaelec (both are case-sensitive)**. Click the "LOGIN" button.
4. You should arrive at the User Menu. Click on the second box "My Courses".
5. A list of courses will appear. Click on the title of the course you wish to begin and follow the instructions.

Final Exam: 2014 NEC Changes - Articles 90, 100, and 110 (RV-10512)

1. Which one of the following articles did the NEC add to address installations of fire-resistive cables, critical to function during a fire?
 - A. Article 393
 - B. Article 646
 - C. Article 728
 - D. Article 750

2. Voltage threshold has been moved from 600 volts to ____ volts in several locations throughout the NEC.
 - A. 700
 - B. 800
 - C. 900
 - D. 1000

3. 90.1. The purpose of the NEC is:
 - A. Promote the practical safeguarding of persons and property from hazards arising from the use of electricity
 - B. Provide a design specification
 - C. Provide an instruction manual for untrained persons.
 - D. All of the above

4. 90.2 Scope. The Code does not cover the following:
 - A. Installations in ships, watercraft other than floating buildings, railway rolling stock, aircraft, or automotive vehicles other than mobile homes and recreational vehicles
 - B. Installations underground in mines and self-propelled mobile surface mining machinery and its attendant electrical trailing cable
 - C. Installations of railways for generation, transformation, transmission, or distribution of power used exclusively for operation of rolling stock or installations used exclusively for signaling and communications purposes
 - D. All of the above

5. 90.8(B) Number of Circuits in Enclosures. Limiting the number of circuits in a single enclosure minimizes the effects from a short circuit or ground fault.
 - A. TRUE
 - B. FALSE

6. Accessible, Readily (Readily Accessible). This means that personnel working on equipment that need to be reached quickly for operation, renewal, or inspections should not need to:
 - A. Use tools

- B. Climb over or remove obstacles
- C. Resort to portable ladders
- D. All of the above

7. You have to reach an overcurrent device located above a dryer. Is this considered “readily accessible?”
- A. Yes
 - B. No
8. Charge Controller. This is equipment that is used to charge a battery or other energy storage device and controls:
- A. dc voltage
 - B. dc current
 - C. Both of the above
 - D. None of the above
9. A Communications Raceway is an enclosed channel of metallic materials designed expressly for holding communications wires and cables.
- A. TRUE
 - B. FALSE
10. Control Circuit. The circuit of a control apparatus or system that carries the electric signals directing the performance of the controller but does not carry the main power current.
- A. TRUE
 - B. FALSE
11. Electric-Discharge Lighting covers systems of illumination utilizing:
- A. Fluorescent lamps
 - B. High-intensity discharge (HID) lamps
 - C. Neon tubing.
 - D. All of the above
12. Which statement below describes a Ground Fault:
- A. An electrically conductive path from the point of a ground fault on a wiring system through normally non-current-carrying conductors, equipment, or the earth to the electrical supply source.
 - B. An unintentional, electrically conductive connection between an ungrounded conductor of an electrical circuit and the normally non-current-carrying conductors, metallic enclosures, metallic raceways, metallic equipment, or earth.
 - C. The conductive path(s) that provides a ground-fault current path and connects normally non-current-carrying metal parts of equipment together and to the system grounded conductor or to the grounding electrode conductor, or both.
 - D. None of the above

13. Which choice below is not correct regarding the definition of Hybrid System?
- A. A system comprised of multiple power sources
 - B. Power sources could include photovoltaic, wind, micro-hydro generators
 - C. Power sources include electric power production and distribution network systems
 - D. Power sources could include engine-driven generators
14. Which choice below is not correct regarding the definition of Industrial Control Panel?
- A. An assembly of two or more components consisting of one of the following: power circuit components only, such as motor controllers, overload relays, fused disconnect switches, and circuit breakers
 - B. An assembly of two or more components consisting of one of the following: control circuit components only, such as push buttons, pilot lights, selector switches, timers, switches, and control relays
 - C. An assembly of two or more components consisting of one of the following: a combination of power and control circuit components.
 - D. An assembly that includes the controlled equipment.
15. An Overcurrent Protective Device, Branch-Circuit is a device capable of providing protection for service, feeder, and branch circuits and equipment over the full range of overcurrents between its rated current and its interrupting rating. Such devices are
- A. 10000 amperes
 - B. 5000 amperes
 - C. 3000 amperes
 - D. 1000 amperes
16. Premises Wiring (Systems) wiring do not include wiring internal to appliances, luminaires, motors, controllers, motor control centers, and similar equipment.
- A. TRUE
 - B. FALSE
17. The 2011 NEC did not provide the term _____ nor a definition of the same.
- A. Qualified Person
 - B. Raceway
 - C. Retrofit kit
 - D. Sealed Equipment
18. A Substation is an enclosed assemblage of equipment through which electric energy is passed for the purpose of distribution, switching, or modifying its characteristics. A Substation includes:
- A. Switches
 - B. Interrupting devices and circuit breakers
 - C. Buses, and transformers
 - D. All of the above
19. 110.14 Electrical Connections Clarified Information Note. Many terminations and equipment are marked with tightening torque.

- A. TRUE
- B. FALSE

20. 110.16 Arc-Flash Hazard Warning. The revision to this definition clarifies that the required arc-flash warning label must be applied at the factory by a manufacturer.
- A. TRUE
 - B. FALSE
21. 110.21 Field-Applied Hazard Markings. Which of the following is true when caution, warning, or danger signs or labels are required by this Code?
- A. The marking shall adequately warn of the hazard using effective words and/or colors and/or symbols.
 - B. The label shall be permanently affixed to the equipment or wiring method and shall not be hand written.
 - C. Both are true
 - D. None are true
22. 110.24 Available Fault Current (A) Field Marking. Service equipment in other than dwelling units shall be legibly marked in the field with the _____ available fault current. The field marking(s) shall include the date the fault current calculation was
- A. Maximum
 - B. Minimum
 - C. Expected
 - D. None of the above
23. 110.26 Spaces About Electrical Equipment. (C) Entrance to and Egress from Working Space. (3) Personnel Doors. The NEC lowered the ampere value related to provisions for "Personnel doors" for "Entrance to and Egress from Working Space" to ____ amperes from
- A. 1000
 - B. 900
 - C. 800
 - D. 600
24. 110.26 Space about Electrical Equipment (E) (b) Dedicated Equipment Space. The space equal to the width and depth of the equipment and extending from grade to a height of _____ above the equipment shall be dedicated to the electrical installation. No p
- A. 2 ft
 - B. 3 ft
 - C. 4 ft
 - D. 6 ft
25. 110.27 Guarding of Live Parts. (A) Live Parts Guarded Against Accidental Contact. (4). A revision for "Guarding of Live Parts" increases the elevation of live parts against accidental contact to _____ when voltages range from 301 to 600 volts.
- A. 10 ft

- B. $8 \frac{1}{2}$ ft
- C. 9 ft
- D. None of the above

Final Exam: 2014 NEC Changes - Chapter 2: Wiring and Protection (RV-10513)

1. Chapter 2 is primarily concerned with:
 - A. Correctly installing the conductors that make up circuits
 - B. Correctly sizing and protecting circuits
 - C. Addressing the types of loads permitted to be controlled through energy management
 - D. Installing low-voltage Class 2 ac and dc volt equipment connected to ceiling grids

2. Article 200 provides requirements for the following:
 - A. Identification of terminals
 - B. Grounded conductors in premises wiring systems
 - C. Identification of grounded conductors
 - D. All of the above

3. 200.6 Means of Identifying Grounded Conductors. (A) Sizes 6 AWG or Smaller. An insulated grounded conductor of 6 AWG or smaller shall be identified by one of the following means. Which statement is not correct?
 - A. A continuous white outer finish.
 - B. A continuous green outer finish.
 - C. Three continuous white or gray stripes along the conductor's entire length on other than green insulation.
 - D. Wires that have their outer covering finished to show a white or gray color but have colored tracer threads in the braid identifying the source of manufacture shall be considered as meeting the provisions of this section.

4. Positive Polarity. Sizes 6 AWG or Smaller. Where the positive polarity of a dc system does not serve as the connection point for the grounded conductor, each positive ungrounded conductor shall be identified. Select which means of identification does NOT apply.
 - A. A continuous red outer finish.
 - B. A continuous black outer finish.
 - C. A continuous red stripe durably marked along the conductor's entire length on insulation of a color other than green, white, gray, or black.
 - D. Imprinted plus signs "+" or the word "POSITIVE" or "POS" durably marked on insulation of a color other than green, white, gray, or black, and repeated at intervals not exceeding 610 mm (24 in.) in accordance with 310.120(B).

5. ARTICLE 210 — Branch Circuits contains the requirements for branch circuits, such as:
 - A. Conductor sizing and identification
 - B. GFCI protection
 - C. Receptacle and lighting outlet requirements
 - D. All of the above

6. 210.8 - Ground-Fault Circuit-Interrupter - Protection for Personnel. (A) Dwelling Units. (7) Sinks. GFCI protection is required within _____ of all dwelling unit sinks (including kitchen sinks).
- A. 2 ft
 - B. 4 ft
 - C. 6 ft
 - D. 8 ft
7. 210.8 Ground-Fault Circuit-Interrupter Protection for Personnel. (A) Dwelling Units. (10) Laundry areas. All dwelling unit laundry areas now require GFCI protection for 125-volt, single-phase, 15- and 20-ampere receptacles, regardless of the presence of a sink or the distance from the same.
- A. TRUE
 - B. FALSE
8. 210.12 Arc-Fault Circuit-Interrupter Protection. (A) Dwelling Units. (3) b. The maximum length of the branch-circuit wiring from the branch-circuit overcurrent device to the first outlet shall not exceed _____ for a 14 AWG conductor or 21.3 m (70 ft) for a 12 AWG conductor.
- A. 20 ft
 - B. 30 ft
 - C. 40 ft
 - D. 50 ft
9. 210.12 Arc-Fault Circuit-Interrupter Protection. (B) Branch Circuit Extensions or Modifications — Dwelling Units. Exception. AFCI protection shall not be required where the extension of the existing conductors is not more than _____ and does not include any additional outlets or devices.
- A. 2 ft
 - B. 4 ft
 - C. 6 ft
 - D. 8 ft
10. In the 2014 release of the NEC, the requirement for AFCI protection was expanded to include (choose all that apply):
- A. Garages.
 - B. Kitchens.
 - C. Laundry Rooms.
 - D. Bathrooms.
11. 210.13 Ground Fault Protection of Equipment. The NEC added a new section that requires each branch-circuit disconnect rated 1000 amperes or more and installed on solidly grounded wye electrical systems of more than 150 volts to ground, but not exceeding _____ phase-to-phase to be provided with GFP of equipment in accordance with the provisions of 230.95.
- A. 400 volts
 - B. 600 volts
 - C. 700 volts

D. 1000 volts

12. 210.17 Electric Vehicle Branch Circuit. Outlet(s) installed for the purpose of charging electric vehicles shall be supplied by a separate branch circuit. This circuit shall have no other outlets.
- A. TRUE
 - B. FALSE
13. 210.52 Garages. In each attached garage and in each detached garage with electric power, the branch circuit supplying this receptacle(s):
- A. Can supply outlets outside of the garage. At least one receptacle outlet shall be installed for each car space.
 - B. Shall not supply outlets outside of the garage. At least one receptacle outlet shall be installed for each car space.
 - C. Shall not supply outlets outside of the garage. At least one receptacle outlet shall be installed in the garage.
 - D. None of the above is true.
14. 210.52 Dwelling Unit Receptacle Outlets. (E) Outdoor Outlets. (3) Balconies, Decks and Porches. Balconies, decks and porches that are attached to the dwelling unit and are accessible from inside the dwelling unit shall have at least one receptacle outlet accessible from the balcony, deck or porch. The receptacle outlet shall not be located more than _____ above the balcony, deck, or porch walking surface.
- A. 10 ft
 - B. 6 ½ ft
 - C. 5 ft
 - D. 4 ft
15. 210.64 Electrical Service Areas. At least one 125-volt, single-phase, 15- or 20-ampere-rated receptacle outlet shall be installed within _____ of the electrical service equipment.
- A. 20 ft
 - B. 30 ft
 - C. 50 ft
 - D. 60 ft
16. 220.12 Lighting Load for Specified Occupancies. Exception. Where the building is designed and constructed to comply with an energy code adopted by the local authority, the lighting load shall be permitted to be calculated at the values specified in the energy code where the following conditions are met:
- A. A power monitoring system is installed that will provide continuous information regarding the total general lighting load of the building.
 - B. The power monitoring system will be set with alarm values to alert the building owner or manager if the lighting load exceeds the values set by the energy code.
 - C. The demand factors specified in 220.42 are not applied to the general lighting load.
 - D. All of the above

17. 230.44 Cable Trays. Cable trays containing service-entrance conductors are required to include warning labels, spaced at intervals not to exceed _____.
- A. 5 ft
 - B. 10 ft
 - C. 15 ft
 - D. 20 ft
18. 240.87 Arc Energy Reduction. What is the limitation the NEC added to the size of breaker required to comply with section 240.87?
- A. 1100 amperes
 - B. 1200 amperes
 - C. 1300 amperes
 - D. 1400 amperes
 - E. 1500 amperes
19. 250.8 Connection of Grounding and Bonding Equipment. (A) Permitted Methods. Equipment grounding conductors, grounding electrode conductors, and bonding jumpers shall be connected by one or more of the following means:
- A. Listed pressure connectors
 - B. Terminal bars
 - C. Pressure connectors listed as grounding and bonding equipment
 - D. Any of the above
20. 250.64 Grounding Electrode Conductor Installation. (B) Securing and Protection Against Physical Damage. The NEC added new provisions to clarify that grounding electrode conductors and grounding electrode bonding jumpers are required to comply with 300.5 for underground installations.
- A. TRUE
 - B. FALSE
21. 250.166 Size of the Direct Current Grounding Electrode Conductor. The grounding electrode conductor for a dc system shall meet the sizing requirements in this section but shall not be required to be larger than ___ copper or 250 kcmil aluminum.
- A. 1/0 copper
 - B. 3/0 copper
 - C. 4/0 copper
 - D. None of the above
22. 250.194 Grounding and Bonding of Fences and Other Metal Structures. (A) Metal Fences. Where metal fences are located within _____ of the exposed electrical conductors or equipment, the fence shall be bonded to the grounding electrode system with wire-type bonding jumpers.
- A. 10 ft
 - B. 12 ft
 - C. 16 ft
 - D. 20 ft

23. 250.194 Grounding and Bonding of Fences and Other Metal Structures. (A) Metal Fences. (B) Metal Structures. All exposed conductive metal structures, including guy wires within 2.5 m (8 ft) vertically or _____ horizontally of exposed conductors or equipment and subject to contact by persons, shall be bonded to the grounding electrode systems in the area.
- A. 16 ft
 - B. 14 ft
 - C. 12 ft
 - D. 10 ft
24. 250.66 Size of Alternating Current Grounding Electrode Conductor. Where the grounding electrode conductor is connected to a single or multiple concrete-encased electrode(s) as permitted in 250.52(A)(3), that portion of the conductor that is the sole connection to the grounding electrode(s) shall not be required to be larger than:
- A. 4 AWG aluminum wire
 - B. 6 AWG copper wire
 - C. 4 AWG copper wire
 - D. 6 AWG aluminum wire
25. 285.13 Type 4 and Other Component Type SPDs (Surge Protective device (s) can be installed in the field.
- A. TRUE
 - B. FALSE

Attachment #1: Course Syllabus

Course Title:

2014 NEC Changes - Chapter 3 and Chapter 4 (RV-PGM102)

Course Hours:

3 hours

Course Instructor:

Neal Burdick

Course Description:

The 2014 NEC provides an accurate, reliable, and authoritative account of the hundreds of significant revisions in the 2014 Code.

This Course provides coverage of significant changes in the 2014 National Electrical Code®. With every new edition of the NEC, some of the changes include new requirements to sections, while some of the changes include entirely new articles. Some changes are revisions to existing requirements while others are deletions to some existing requirements.

Chapter 3 covers wiring methods and materials, and provides some very specific installation requirements for conductors, cables, boxes, raceways, and fittings. This chapter includes detailed information about installation and restrictions involved with wiring methods. The chapter begins with rules that are common to most wiring methods, it then covers conductors and enclosures. The articles that follow become more specific and deal in more depth with individual wiring methods such as specific types of cables and various raceways. The chapter winds up with article 392, a support system, and the final articles for open wiring.

Chapter 4 deals with equipment for general use.

NOTE: This course is formatted in 2 lessons with the exam given at the end of each lesson. Each lesson must be passed with a score of 70% or higher before being allowed to proceed to the next lesson. The lessons are listed below:

Lesson 1: 2014 NEC Changes - Chapter 3: Wiring Methods and Materials

Lesson 2: 2014 NEC Changes - Chapter 4: Equipment for General Use

Course Objectives:

By the end of this course, you will be able to:

- Recognize the provisions that are considered necessary for safety of the public and compliance that is essentially free from hazard
- Describe the new item that was added to address safety concerns for conductors in raceways that ensure the safety of the public
- Identify the intervals in which vertical installation with ungrounded conductors must be secured for safe placement in a building
- Recognize that the NEC® contains provisions that are considered necessary for safety. Compliance therewith and proper maintenance results in an installation that is essentially free from hazard
- Describe the NEC® code for safety requirements on flexible cords and cable tags

- Identify the NEC® code for safe installation of switch controlled lighting loads
- Identify the change to the placement of GFCI devices for appliances
- Explain the new safety requirements for the installation of duct heaters with limited access

Lesson 1 Outline:

Introduction

Article 300 - General Requirements for Wiring Methods and Materials

- Article 300 Wiring Methods, and 300.1 Scope (A) All Wiring Installations
- 300.6 Protection Against Corrosion and Deterioration
- 300.11 Securing and Supporting
- 300.22 Wiring in Ducts Not Used for Air Handling, Fabricated Ducts for Environmental Air, and Other Spaces -for Environmental Air (Plenums) 300.38 Raceways in Wet Locations Above Grade

Article 310 Conductors for General Wiring

- 310.10 Uses Permitted
- 310.15 Ampacities for Conductors Rated 0–2000 Volts

Article 314 Outlet, Device, Pull, and Junction Boxes; Conduit Bodies; Fittings; and Handhole Enclosures

- 314.15 Damp or Wet Locations
- 314.23(B) Supports
- 314.25 Covers and Canopies
- 314.27 Outlet Boxes

Article 324 Flat Conductor Cable: Type FCC

- 324.41 Floor Coverings

Article 330 Metal-Clad Cable: Type MC

- 330.30 Securing and Supporting (Type MC cable)

Article 334 Nonmetallic-Sheathed Cable: Types NM, NMC, and NMS

- 334.40 Boxes and Fittings

Article 344 Rigid Metal Conduit: Type RMC

- 344.2 Definition and 344.100 Construction

Article 348 Flexible Metal Conduit: Type FMC

- 348.30 Securing and Supporting

Article 350 Liquidtight Flexible Metal Conduit: Type LFMC

- 350.42 Couplings and Connectors

Article 356 Liquid tight Flexible Nonmetallic Conduit (LFNC)

- 356.12 Uses Not Permitted

Article 370 Cablebus

- Article 370.1 – 370.120

Article 376 Metal Wireways

- 376.22 Number of Conductors and Ampacity
- 376.56 Splices, Taps, and Power Distribution Blocks

Article 386 Surface Metal Raceways

- 386.120 Marking

Article 392 Cable Trays

- 392.10 Uses Permitted
- 392.18 Cable Tray Installation

- 392.20 Cable and Conductor Installation

Article 393 - Low-Voltage Suspended Ceiling Power Distribution Systems

- 393.1 – 393.104

Article 399 Outdoor Overhead Conductors over 1000 Volts

- 399.2 Definition. (Outdoor Overhead Conductors over 1000 Volts)

Conclusion

Lesson 2 Outline:

Introduction

Article 400 Flexible Cords and Cables

- 400.1 Scope & 400.4 Types (Flexible Cords and Cables)
- 400.5 Ampacities for Flexible Cords and Cables
- 400.6 Markings
- 400.7 Uses Permitted

Article 404 Switches

- 404.1 Scope & 404.2 Switch Connections
- 404.8 Accessibility and Grouping

Article 406 Receptacles, Cord Connectors, and Attachment Plugs (Caps)

- 406.1 Scope & 406.3 Receptacle Rating and Type
- 406.4 General Installation Requirements
- 406.5 Receptacle Mounting
- 406.9 Receptacles in Damp or Wet Locations
- 406.12 Tamper-Resistant Receptacles
- 406.15 Dimmer Controlled Receptacles

Article 408 Switchboards, Switchgear, and Panelboards

- 408.3 Support and Arrangement of Busbars and Conductors
- 408.4 Field Identification Required
- 408.55 Wire-Bending Space Within an Enclosure Containing a Panelboard

Article 409 Industrial Control Panels

- 409.1 Scope & 409.20 Conductors – Minimum Size and Ampacity. (Industrial Control Panels)

Article 410 Luminaires, Lampholders, and Lamps

- 410.1 Scope & 410.6 Listing Required
- 410.10 Luminaires in Specific Locations
- 410.130 General. (Electric Discharge Lighting Systems of 1000 Volts or Less)

Article 422 Appliances

- 422.1 Scope & 422.5 Ground-Fault Circuit-Interrupter (GFCI) Protection
- 422.11 Overcurrent Protection
- 422.23 Tire Inflation and Automotive Vacuum Machines
- 422.49 High-Pressure Spray Washers
- 422.51 Cord-and-Plug-Connected Vending Machines

Article 424 Fixed Electric Space-Heating Equipment

- 424.1 Scope & 424.19 Disconnecting Means. (Fixed Electric Space-Heating Equipment)
- 424.66 Installations

Article 430 Motors, Motor Circuits, and Controllers

- 430.1 Scope & 430.22 Single Motor

- 430.52 Rating or Setting for Individual Motor Circuit
- 430.53 Several Motors or Loads on One Branch Circuit
- 430.233 Guards for Attendants

Article 440 Air-Conditioning and Refrigerating Equipment

- 440.1 Scope & 440.9 Grounding and Bonding

Article 445 Generators

- 445.1 Scope & 445.11 Marking
- 445.18 Disconnecting Means Required for Generators
- 445.20 Ground-Fault Circuit-Interrupter Protection for Receptacles on 15-kW or Smaller
- Portable Generators

Article 450 Transformers and Transformer Vaults (Including Secondary Ties)

- 450.1 Scope & 450.10 Grounding
- 450.11 Marking

Article 480 Storage Batteries

- 480.1 to 480.10

Article 490 Equipment Over 1000 Volts, Nominal

- 490.1 Scope & 490.48 Substations

Conclusion



2014 NEC Changes - Chapter 3: Wiring Methods and Materials

Table of Contents

Introduction	4
Course Overview	4
Learning Objectives	5
Article 300 - General Requirements for Wiring Methods and Materials	5
Article 300 Wiring Methods, and 300.1 Scope (A) All Wiring Installations	5
300.6 Protection Against Corrosion and Deterioration	5
300.11 Securing and Supporting	6
300.22 Wiring in Ducts Not Used for Air Handling, Fabricated Ducts for Environmental Air, and Other Spaces for Environmental Air (Plenums).....	7
300.38 Raceways in Wet Locations Above Grade	8
ARTICLE 310 Conductors for General Wiring	8
310.10 Uses Permitted	8
310.15 Ampacities for Conductors Rated 0–2000 Volts	9
310.15 Ampacities for Conductors Rated 0–2000 Volts	11
ARTICLE 314 Outlet, Device, Pull, and Junction Boxes; Conduit Bodies; Fittings; and Handhole Enclosures	13
314.15 Damp or Wet Locations	13
314.23(B) Supports	14
314.25 Covers and Canopies	14
314.25 Covers and Canopies	14
314.27 Outlet Boxes	15
ARTICLE 324 Flat Conductor Cable: Type FCC	16
324.41 Floor Coverings	16
ARTICLE 330 Metal-Clad Cable: Type MC	17
330.30 Securing and Supporting (Type MC cable)	17
ARTICLE 334 Nonmetallic-Sheathed Cable: Types NM, NMC, and NMS	18
334.40 Boxes and Fittings	18
ARTICLE 344 Rigid Metal Conduit: Type RMC	19
344.2 Definition and 344.100 Construction	19
344.100 Construction	19
ARTICLE 348 Flexible Metal Conduit: Type FMC	20
348.30 Securing and Supporting	20
ARTICLE 350 Liquidtight Flexible Metal Conduit: Type LFMC	20

2014 NEC Changes - Chapter 3: Wiring Methods and Materials

350.42 Couplings and Connectors.....	20
ARTICLE 356 Liquidtight Flexible Nonmetallic Conduit (LFNC)	21
356.12 Uses Not Permitted.....	21
ARTICLE 370 Cablebus.....	22
Article 370.1 – 370.120.....	22
ARTICLE 376 Metal Wireways	25
376.22 Number of Conductors and Ampacity	25
376.56 Splices, Taps, and Power Distribution Blocks	25
ARTICLE 386 Surface Metal Raceways.....	26
386.120 Marking.....	26
ARTICLE 392 Cable Trays.....	26
392.10 Uses Permitted	27
392.18 Cable Tray Installation	29
392.20 Cable and Conductor Installation	29
ARTICLE 393 - Low-Voltage Suspended Ceiling Power Distribution Systems	30
Article 393.1 – 393.104.....	30
ARTICLE 399 Outdoor Overhead Conductors over 1000 Volts.....	32
399.2 Definition. (Outdoor Overhead Conductors over 1000 Volts)	32
Conclusion.....	32
Summary.....	32
Resources.....	33
References.....	33
Author Biography.....	34
Neal L. Burdick.....	34

Introduction

Course Overview

This is the **third** of several courses covering the changes in the 2014 edition of the **National Electrical Code** (NEC) created by the NFPA. The 2014 NEC provides an accurate, reliable, and authoritative account of the hundreds of significant revisions in the 2014 Code.

This course provides coverage of significant changes in the *2014 National Electrical Code*. With every new edition of the NEC, some of the changes include new requirements to sections, while some of the changes include entirely new articles. Some changes are revisions to existing requirements while others are deletions to some existing requirements.

Although not required, **it is recommended to have a copy of the 2014 NEC manual for reference**, especially when reviewing information in large tables.

A **Summary of each change** is followed by the actual NEC Language, with deletions showing with a ~~strikethrough~~ and additions/changes (highlighted in yellow). When necessary, **Comments** are added to appropriate topics.

In many cases, paragraphs not directly affected by a change are retained to preserve context. *There will be no quiz questions on material that does not cover changes in the 2014 NEC.*

The length of each segment varies depending on the topic and material available.

The National Electrical Code is intended for electricians and subcontractors, electrical inspectors, electrical engineers, designers, and other qualified persons who understand electrical currents, theory, safety procedures, and electrical trade practices. The code does not serve as a teaching manual for untrained individuals.

Chapter 3 covers wiring methods and materials, and provides some very specific installation requirements for conductors, cables, boxes, raceways, and fittings.

This chapter includes detailed information about installation and restrictions involved with wiring methods.

The chapter begins with rules that are common to most wiring methods, it then covers conductors and enclosures.

The articles that follow become more specific and deal in more depth with individual wiring methods such as specific types of cables and various raceways.

The chapter winds up with Article 392, a support system, and the final articles for open wiring.

Learning Objectives

By the end of this course, you will be able to:

- Identify the various significant changes in Chapter 3 of the NEC
- Recognize that this NEC contains provisions that are considered necessary for safety and compliance therewith and proper maintenance results in an installation that is essentially free from hazard
- Refer to the appropriate sections of the code and find applicable changes and information
- Describe the new item that was added to address safety concerns for conductors in raceways
- Explain the safety reason for weep holes in field boxes and outlet box hoods
- Identify the safety regulations for the vertical installation's of listed cables with underground conductors
- List the four types of RMC that are approved for protecting and routing conductors and cables
- Identify the safety label that is required on all cable trays

Article 300 - General Requirements for Wiring Methods and Materials

Article 300 Wiring Methods, and 300.1 Scope (A) All Wiring Installations

The NEC revised the *Title* to Article 300. A similar revision to 300.1, *Scope*, was made to better reflect what is covered by Chapter 3 and Article 300.

NEC Language

Article 300 - General Requirements for Wiring Methods and Materials

300.1 Scope.

(A) All Wiring Installations. This article covers general requirements for wiring methods and materials for all wiring installations unless modified by other articles in Chapter 3.

Comments

The NEC revised the scope of Article 300 to assure understanding that the articles in Chapter 3 not only cover the wiring methods in Chapter 3, but the materials used in Chapter 3 as well.

Wiring methods are generally recognized as the particular cable assemblies, conduits, and raceways covered in the individual Chapter 3 wiring method articles of the Code.

These title changes better reflect what is covered by Chapter 3 and Article 300. Specific rules for each wiring method are part of every respective Chapter 3 wiring method article that follows Article 300.

300.6 Protection Against Corrosion and Deterioration

(A) Ferrous Metal Equipment

Informational Note

The NEC added a new **Informational Note** specifying what constitutes "*field-cut threads*."

NEC Language

300.6 Protection Against Corrosion and Deterioration

Raceways, cable trays, cablebus, auxiliary gutters, cable armor, boxes, cable sheathing, cabinets, elbows, couplings, fittings, supports, and support hardware shall be of materials suitable for the environment in which they are to be installed.

(A) Ferrous Metal Equipment

Ferrous metal raceways, cable trays, cablebus, auxiliary gutters, cable armor, boxes, cable sheathing, cabinets, metal elbows, couplings, nipples, fittings, supports, and support hardware shall be suitably protected against corrosion inside and outside (except threads at joints) by a coating of approved corrosion-resistant material.

Where corrosion protection is necessary and the conduit is threaded in the field, the threads shall be coated with an approved electrically conductive, corrosion resistant compound.

Informational Note: Field-cut threads are those threads that are cut in conduit, elbows, or nipples anywhere other than at the factory where the product is listed.

Exception: Stainless steel shall not be required to have protective coatings.

Comments

The NEC added a new *Informational Note* after 300.6(A) detailing that field-cut threads are those threads that are field-applied or cut in conduit, elbows, or nipples anywhere other than at the factory where the product is produced and listed.

This new *Informational Note* better explains what constitutes field-cut threads and what is not a field-cut thread. This should also help alleviate confusion in the installation of field-cut threads in conduits and raceways concerning corrosion protection of these threads.

300.11 Securing and Supporting

(B) Raceways Used as a Means of Support

(1)

This modification specifies that raceways can be used as a means of support where the raceway is identified "as a means of support."

NEC Language

300.11 Securing and Supporting

(B) Raceways Used as a Means of Support. Raceways shall be used only as a means of support for other raceways, cables, or nonelectrical equipment under any of the following conditions:

(1) Where the raceway or means of support is identified for the purpose as a means of support

(2) Where the raceway contains power supply conductors for electrically controlled equipment and is used to support Class 2 circuit conductors or cables that are solely for the purpose of connection to the equipment control circuits

(3) Where the raceway is used to support boxes or conduit bodies in accordance with 314.23 or to support luminaires in accordance with 410.36(E).

Comments

Raceways were permitted to be used as a means of support for other raceways, cables, or nonelectrical equipment where the raceway or means of support was "identified for the purpose."

The revision still permits raceways to be used as a means of support for other raceways, cables, or nonelectrical equipment, but the raceway or means of support must now be "identified as a means of support," not just "identified for the purpose."

300.22 Wiring in Ducts Not Used for Air-Handling, Fabricated Ducts for Environmental Air, and Other Spaces for Environmental Air (Plenums)

(C) Other Spaces Used for Environmental Air (Plenums)

(1) Wiring Methods

Cable ties used to secure cables in plenums must be listed as having fire-resistant and low-smoke producing characteristics.

NEC Language

300.22 Wiring in Ducts Not Used for Air Handling, Fabricated Ducts for Environmental Air, and Other Spaces for Environmental Air (Plenums)

The provisions of this section shall apply to the installation and uses of electrical wiring and equipment in ducts used for dust, loose stock, or vapor removal; ducts specifically fabricated for environmental air; and other spaces used for environmental air (plenums).

(C) Other Spaces Used for Environmental Air (Plenums). This section shall apply to spaces not specifically fabricated for environmental air-handling purposes but used for air-handling purposes as a plenum. This section shall not apply to habitable rooms or areas of buildings, the prime purpose of which is not air handling.

(Please see NEC your copy of the NEC for complete text and Informational Notes.)

Exception: This section shall not apply to the joist or stud spaces of dwelling units where the wiring passes through such spaces perpendicular to the long dimension of such spaces.

(1) Wiring Methods. The wiring methods for such other space shall be limited to totally enclosed, non-ventilated, insulated busway having no provisions for plug-in connections, Type MI cable without an overall nonmetallic covering, Type MC cable without an overall nonmetallic covering, Type AC cable, or other factory-assembled multiconductor control or power cable that is specifically listed for use within an air-handling space, or listed prefabricated cable assemblies of metallic-manufactured wiring systems without nonmetallic sheath. Other types of cables, conductors, and raceways shall be permitted to be installed in electrical metallic tubing, flexible metallic tubing, intermediate metal conduit, rigid metal conduit without an overall nonmetallic covering, flexible metal conduit, or, where accessible, surface metal raceway or metal wireway with metal covers. Nonmetallic cable ties and other nonmetallic cable accessories used to secure and support cables shall be listed as having low smoke and heat release properties.

Informational Note: One method to determine low smoke and heat release properties is that the nonmetallic cable ties and other nonmetallic cable accessories exhibits a maximum peak optical density of 0.50 or less, an average optical density of 0.15 or less and a peak heat release rate of 100 kW or less when tested in accordance with ANSI/UL 2043-2008, Fire Test for Heat and Visible Smoke Release for Discrete Products and Their Accessories Installed in Air-Handling Spaces.

Comments

The NEC added a new sentence at the end of 300.22(C)(1) for wiring methods installed in spaces used for environmental air (plenums). This will require nonmetallic cable ties and other nonmetallic cable accessories used to secure and support cables in these spaces to be listed as having low-smoke and heat-release properties and characteristics.

A new *Informational Note* now provides pertinent information related to low smoke and heat release properties for nonmetallic cable ties.

The revisions and new text bring the NEC requirements for nonmetallic cable ties installed in spaces used for environmental air (plenums) into correlation with *NFPA 90A, Standard for the Installation of Air-Conditioning and Ventilating Systems*. This correlation requires nonmetallic cable ties and other nonmetallic cable accessories used to secure and support cables in plenums to be listed as having low-smoke and heat-release properties.

300.38 Raceways in Wet Locations Above Grade

The NEC now considers interior of raceways installed in wet locations above grade to be a wet location for installations of over 1000 volts, nominal.

NEC Language

300.38 Raceways in Wet Locations Above Grade

Where raceways are installed in wet locations above grade, the interior of these raceways shall be considered to be a wet location.

Insulated conductors and cables installed in raceways in wet locations above grade shall comply with 310.10(C).

Comments

This new requirement reflects the fact that the interior of raceways being declared a wet location when the raceway is installed in wet locations is now complete.

The mere existence of condensation alone renders the interior of these raceways a wet location when these raceways are installed in wet locations, above grade or below, regardless of the voltage involved.

ARTICLE 310 Conductors for General Wiring

310.10 Uses Permitted

(H) Conductors in Parallel**310.10(H)(2) and (6)**

The NEC expanded parallel conductor installations to include grouping requirements for induction purposes.

NEC Language**310.10 Uses Permitted**

The conductors described in 310.104 shall be permitted for use in any of the wiring methods covered in Chapter 3 and as specified in their respective tables or as permitted elsewhere in this Code.

(H) Conductors in Parallel

(1) General. Aluminum, copperclad aluminum, or copper conductors, for each phase, polarity, neutral, or grounded circuit shall be permitted to be connected in parallel (electrically joined at both ends) only in sizes 1/0 AWG and larger where installed in accordance with 310.10(H)(2) through (H)(6).

(Please consult your copy of the NEC for exceptions and complete text.)

(2) Conductor and Installation Characteristics. The paralleled conductors in each phase, polarity, neutral, grounded circuit conductor, equipment grounding conductor, or equipment bonding jumper shall comply with all of the following:

- (1) Be the same length
- (2) Consist of the same conductor material
- (3) Be the same size in circular mil area
- (4) Have the same insulation type
- (5) Be terminated in the same manner
- (6) Where paralleled in ferrous metal enclosures or raceways, conductors shall be grouped with all conductors of the same circuit to prevent heating effects from imbalances of current.

Informational Note: Where conductors are paralleled in enclosures or raceways, failure to group one conductor from each phase in each raceway or grouping within a wiring method may result in overheating and current imbalance.

(Please use your copy of the NEC to review the remainder of 310.10(H) text.)

Comments

Conductors installed in parallel are generally required to be sized at 1/0 or larger.

These parallel conductors are also required to be of the same length, consist of the same conductor material, be of the same size in circular mil area, have the same insulation type, and be terminated in the same manner.

The new item (6) was added to not only require the conductor characteristics required by the previous Code, but also to require paralleled conductors installed in ferrous metal enclosures or raceways to be grouped with all conductors of the same circuit to prevent heating effects from imbalances of current.

310.15 Ampacities for Conductors Rated 0–2000 Volts

310.15(B)(3)(a) and Table 310.15(B)(3)(a)

The titles of 310.15(B)(3)(a) and corresponding table were changed to "*More Than Three Current-Carrying Conductors in a Raceway or Cable.*"

A Note to Table 310.15(B)(3)(a) was revised to make it clear that the table applies to spare conductors but does not apply to conductors that cannot be simultaneously energized.

NEC Language

310.15 Ampacities for Conductors Rated 0–2000 Volts

(B) Tables. Ampacities for conductors rated 0 to 2000 volts shall be as specified in the Allowable Ampacity Table 310.15(B)(16) through Table 310.15(B)(19), and Ampacity Table 310.15(B)(20) and Table 310.15(B)(21) as modified by 310.15(B)(1) through (B)(7).

The temperature correction and adjustment factors shall be permitted to be applied to the Ampacity for the temperature rating of the conductor, if the corrected and adjusted ampacity does not exceed the ampacity for the temperature rating of the termination in accordance with the provisions of 110.14(C).

(Please see your copy of the NEC for the Informational Note and complete text.)

(3) Adjustment Factors

(a) More Than Three Current Carrying Conductors in a Raceway or Cable. Where the number of current-carrying conductors in a raceway or cable exceeds three, or where single conductors or multiconductor cables are installed without maintaining spacing for a continuous length longer than 600 mm (24 in.) and are not installed in raceways, the allowable ampacity of each conductor shall be reduced as shown in Table 310.15(B)(3)(a). Each current-carrying conductor of a paralleled set of conductors shall be counted as a current-carrying conductor.

(Please see your copy of the NEC for the complete text.)

Table 310.15(B)(3)(a) Adjustment Factors for More Than Three Current-Carrying Conductors

Number of Conductors ¹	Percent of Values in Table 310.15(B)(16) through Table 310.15(B)(19) as Adjusted for Ambient Temperature If Necessary
4–6	80
7–9	70
10–20	50
21–30	45
31–40	40
41 and above	35

¹Number of conductors is the total number of conductors in the raceway or cable, including spare conductors. The count shall be adjusted in accordance with 310.15(B)(5) and (6). The count shall not include conductors that are connected to electrical components but that cannot be simultaneously energized.

Source: NEC 2014

Comments

The NEC revised the note to Table 310.15(B)(3)(a) to make it clear that the table applies to the total number of conductors in the raceway or cable, etc., as well as to spare conductors; but the table does not apply to conductors that cannot be simultaneously energized.

Another revision occurred at the note at the bottom of the Table provides a better understanding as to exactly which conductors this table does and does not apply to.

Added language in the note makes it clear that spare conductors are to be counted in the total number of conductors involved. In addition, the language indicates that when two or more conductors cannot be simultaneously energized, only one of the conductors would be counted in the total number of conductors.

310.15 Ampacities for Conductors Rated 0–2000 Volts

310.15(B)(3)(c) EX and Table 310.15(B)(3)(c)

The NEC revised the Title for clarity and added a new exception to permit the use of Type XHHW-2 conductors in raceways or cables on rooftops without having to apply an ambient temperature adjustment correction factor.

NEC Language

310.15 Ampacities for Conductors Rated 0–2000 Volts

(B) Tables. Ampacities for conductors rated 0 to 2000 volts shall be as specified in the Allowable Ampacity Table 310.15(B)(16) through Table 310.15(B)(19), and Ampacity Table 310.15(B)(20) and Table 310.15(B)(21) as modified by 310.15(B)(1) through (B)(7).

(Please refer to your copy of the NEC for the complete text.)

(3) Adjustment Factors

(c) ~~Circular~~ Raceways and Cables Exposed to Sunlight on Rooftops

Where ~~conductors or cables are installed in circular~~ raceways or cables are exposed to direct sunlight on or above rooftops, the adjustments shown in Table 310.15(B)(3)(c) shall be added to the outdoor temperature to determine the applicable ambient temperature for application of the correction factors in Table 310.15(B)(2)(a) or Table 310.15(B)(2)(b).

Informational Note: One source for the average ambient temperatures in various locations is the ASHRAE Handbook, Fundamentals.

Exception: Type XHHW-2 insulated conductors shall not be subject to this ampacity adjustment.

Comments

The basic provisions for applying an ambient temperature adjustment correction factor where any type of raceway (not just circular raceways) is exposed to direct sunlight on or above rooftops have not changed.

The NEC added provisions for cables installed on or above rooftops.

Cables were subject to these ambient temperature adjustment correction factors in the past, but the language indicated that the cable(s) had to be installed in a raceway.

The NEC added a new exception that allows the employment of Type XHHW-2 conductors, which is a thermoset insulated conductor, to be installed in raceways or cables on rooftops without having to apply an ambient temperature adjustment correction factor for these conductors.

310.15 Ampacities for Conductors Rated 0–2000 Volts

(B) Tables

(7) 120/240-Volt, Single-Phase

This revision deletes Table 310.15(B)(7) and replaces it with a provision allowing an 83% revision in ampacity for dwelling service and feeder conductors.

NEC Language

310.15 Ampacities for Conductors Rated 0–2000 Volts

(B) Tables. Ampacities for conductors rated 0 to 2000 volts shall be as specified in the Allowable Ampacity Tables 310.15(B)(16) through Table 310.15(B)(19), and Ampacity Table 310.15(B)(20) and Table 310.15(B)(21) as modified by 310.15(B)(1) through (B)(7).

(Please see your copy of the NEC for the complete text.)

(7) 120/240-Volt, Single-Phase Dwelling Services and Feeders

~~For individual dwelling units one-family dwellings and the individual dwelling units of two family and multifamily dwellings, service and feeder conductors as listed in Table 310.15(B)(7), shall be permitted as supplied by a single-phase, 120/240-volt, 3-wire, service-entrance conductors, service-lateral conductors, and feeder conductors that serve as the main power feeder to each dwelling unit and are installed in raceway or cable with or without an equipment-grounding conductor system shall be permitted be sized in accordance with 310.15(B)(7)(a) through (d).~~

A cleaned up version of the above paragraph is as follows:

(7) 120/240-Volt, Single-Phase Dwelling Services and Feeders. For one-family dwellings and the individual dwelling units of two-family and multifamily dwellings, service and feeder conductors supplied by a single-phase, 120/240-volt system shall be permitted be sized in accordance with 310.15(B)(7)(1) through (4).

(1) For a service rated 100 through 400 amperes, the service conductors supplying the entire load associated with a one-family dwelling or the service conductors supplying the entire load associated with an individual dwelling unit in a two-family or multi-family dwelling shall be permitted to have an ampacity not less than 83% of the service rating.

(2) For a feeder rated 100 through 400 amperes, the feeder conductors supplying the entire load associated with a one-family dwelling or the feeder conductors supplying the entire load associated with an individual dwelling unit in a two-family or multifamily dwelling shall be permitted to have an ampacity not less than 83% of the feeder rating.

(3) In no case shall a feeder for an individual dwelling unit be required to have an ampacity rating greater than ~~their service-entrance conductors~~ that of its 310.15(B)(7) (a) or (b) conductors.

(4) ~~The~~ Grounded conductors shall be permitted to be sized smaller than the ungrounded conductors provided the requirements of 245.2, 220.61 and 230.42 for service conductors or the requirements of 215.2 and 220.61 for feeder conductors are met.

Informational Note No. 1: It is possible that the conductor ampacity will require other correction or adjustment factors applicable to the conductor installation.

Informational Note No. 2: See example D.7 in Annex D.

Comments

The NEC deleted Table 310.15(B)(7).

The parent text at 310.15(B)(7) was revised and broken up into four list items.

Rather than using the previous Table 310.15(B)(7) for sizing service conductors and the main power feeder for dwelling units, we are left with a calculation to perform. The ampacity values at Table 310.15(B)(16) can be reduced by 17 percent (not less than 83 percent of the service or feeder rating), which will require the circular mils properties of Table 8 in Chapter 9 to be brought into the now required calculation.

A new *Informational Note* takes users of the Code to Example D.7 in Annex D for an example of how to perform this dwelling unit service and feeder calculation.

ARTICLE 314 Outlet, Device, Pull, and Junction Boxes; Conduit Bodies; Fittings; and Handhole Enclosures

314.15 Damp or Wet Locations

All outlet box hood covers are now required to be listed for use in a wet location, not just extra duty outlet box hood covers installed in wet locations.

The NEC added a new provision to permit field-installed drainage openings in boxes or conduit bodies in accordance with the manufacturer's instructions.

NEC Language

314.15 Damp or Wet Locations

In damp or wet locations, boxes, conduit bodies, and fittings shall be placed or equipped so as to prevent moisture from entering or accumulating within the box, conduit body, or fitting. Boxes, conduit bodies, outlet box hoods, and fittings installed in wet locations shall be listed for use in wet locations. Approved drainage openings not larger than 6 mm (1/4 in.) shall be permitted to be installed in the field in boxes or conduit bodies listed for use in damp or wet locations. For installation of listed drain fittings, larger openings are permitted to be installed in the field in accordance with manufacturer's instructions.

Comments

The NEC added the term *outlet box hoods* at this section. Boxes, conduit bodies, outlet box hoods, and fittings installed in wet locations are now required to be listed for use in wet locations.

The 2011 NEC had no language to allow field-installed weep holes to be installed in the bottom of boxes and conduit fittings, although this was a fairly common practice by installers.

The NEC also added a new sentence at the end of 314.15 to permit approved drainage openings to be installed in the field in boxes or conduit bodies listed for use in damp or wet locations in accordance with manufacturer's instructions. These weep holes cannot be larger than 6 mm (1/4 in.).

The installation of weep holes in the bottom of boxes installed in wet locations improves the safety and durability of electrical installations. Without these weep holes, the inside of cast aluminum boxes and other metallic enclosures can degrade over time due to moisture condensation. Experienced installers will typically provide weep holes in the underside that provide enough ventilation to avoid such damage.

314.23(B) Supports

(B) Structural Mounting

Enclosures can now be supported from any structural member, not just from a structural member of a building.

NEC Language

314.23(B) Supports

(B) Structural Mounting

An enclosure supported from a structural member ~~of a building~~ or from grade shall be rigidly supported either directly or by using a metal, polymeric, or wood brace.

Comments

Outlet, device, junction or pull boxes, conduit body, or fitting that were supported from a structural member had to be supported from a structural member of a building.

The NEC removed the words "of a building" to indicate that an enclosure within the scope of Article 314 could be supported from any structural member, not just a structural member of a building.

314.25 Covers and Canopies

The NEC now specifies that drywall screws are not permitted to be used to attach box covers or other equipment fastened to a box.

Cover and canopy screws need to be suitable for this purpose.

NEC Language

314.25 Covers and Canopies

In completed installations, each box shall have a cover, faceplate, lampholder, or luminaire canopy, except where the installation complies with 410.24(B). Screws used for the purpose of attaching covers, or other equipment to the box, shall be either machine screws matching the thread gauge or size that is integral to the box or shall be in accordance with the manufacturer's instructions.

Comments

The requirement at 314.25 generally required boxes to have covers, faceplates, etc., installed for a complete installation; but the means of attachment for these covers was not addressed.

The NEC added a new sentence at the end of 314.25 addressing the attachment means for covers or other equipment attached to a box.

Screws used for this purpose are now required to be either machine screws matching the thread gauge or of a size that is integral to the box.

The screws and attachment process can also be installed in accordance with the manufacturer's instructions.

The use of screws not designed for the purpose, such as drywall screws, for attaching covers, luminaires, or other equipment to boxes has become a concern in the electrical industry. This practice is unacceptable and can result in damage to the box and inadequate support of the

attached luminaire or equipment itself. Installers should always follow the manufacturer's installation instructions, but having Code language against this practice will help ensure proper support.

314.27 Outlet Boxes

(A) Boxes at Luminaire or Lampholder Outlets

(1) Vertical Surface Outlets.

The NEC now specifies that the requirements of 314.27(A) (1) apply to outlet boxes used to support luminaires and lampholders mounted on vertical surfaces (not just on walls).

NEC Language

314.27 Outlet Boxes

(A) Boxes at Luminaire or Lampholder Outlets

Outlet boxes or fittings designed for the support of luminaires and lampholders, and installed as required by 314.23, shall be permitted to support a luminaire or lampholder.

(1) Wall Vertical Surface Outlets.

Boxes used at luminaire or lampholder outlets in ~~a wall~~ or on a vertical surface shall be identified and marked on the interior of the box to indicate the maximum weight of the luminaire that is permitted to be supported by the box ~~in the wall~~, if other than 23 kg (50 lb).

Exception: A ~~wall-~~ vertically mounted luminaire or lampholder weighing not more than 3 kg (6 lb) shall be permitted to be supported on other boxes or plaster rings that are secured to other boxes, provided the luminaire or its supporting yoke, or the lampholder, is secured to the box with no fewer than two No. 6 or larger screws.

Comments

The NEC changed the title of 314.27(A)(1) from "Wall Outlets" to "Vertical Surface Outlets" as not all vertical surfaces where luminaires or lamp holders are mounted are necessarily in a wall.

The text was also revised in the subsection and the exception reflecting this vertical surface vs. wall surface fact.

314.27 Outlet Boxes

(A) Boxes at Luminaire or Lampholder Outlets.

(2) Ceiling Outlets

Outlet boxes used to support ceiling-mounted luminaires that weigh more than 23 kg (50 lb) are now required to be marked, on the interior of the box, with the maximum weight the box will support.

NEC Language

314.27 Outlet Boxes

(A) Boxes at Luminaire or Lampholder Outlets.

(2) Ceiling Outlets

At every outlet used exclusively for lighting, the box shall be designed or installed so that a luminaire or lampholder may be attached. Boxes shall be required to support a luminaire weighing a minimum of 23 kg (50 lb). A luminaire that weighs more than 23 kg (50 lb) shall be supported independently of the outlet box, unless the outlet box is listed and marked on the interior of the box to indicate for the maximum weight the box shall be permitted to be supported support.

Comments

Outlet boxes that support a ceiling-mounted luminaire or lampholder are required to be designed for that purpose. These boxes are required to support a luminaire weighing a minimum of 23 kg (50 lb). In cases where a luminaire weighs more than 23 kg (50 lb), the luminaire must be supported independently of the outlet box, unless the outlet box is listed and marked for the maximum weight to be supported.

In situations where an outlet box is intended to support a luminaire weighing more than 23 kg (50 lb), a revision to 314.27(A)(2) will now require a ceiling-mounted outlet box to be listed and marked, on the interior of the box, for the maximum weight [other than 23 kg (50 lb)] that the outlet box is designed to support. Otherwise, the luminaire must be supported independently of the outlet box.

In order for a ceiling-mounted outlet box to support a luminaire weighing more than 23 kg (50 lb), that ceiling-mounted outlet box would be required to be listed and marked for the maximum weight that particular outlet box is designed to support.

This maximum weight marking is now required to be on the interior of the box. This will allow the installer of the luminaire and the electrical inspector an opportunity to review this information at the time of installation, without having to climb into the attic to retrieve same.

In some cases, the exterior of the outlet box is not accessible after a certain point in the building construction process, such as after the sheetrock or exterior finish of the walls and ceiling has been installed.

From a practical standpoint, this is a necessary change to assist the installer and enforcement community.

ARTICLE 324 Flat Conductor Cable: Type FCC

324.41 Floor Coverings

Carpet squares that cover flat conductor cable (Type FCC) are now required to be no larger than 1.0 m (39.37 in.) square.

NEC Language

324.41 Floor Coverings

Floor-mounted Type FCC cable, cable connectors, and insulating ends shall be covered with carpet squares not larger than ~~914 mm (36 in.)~~ 1.0 m (39.37 in.) square.

Carpet squares that are adhered to the floor shall be attached with release-type adhesives.

Comments

The maximum size modular carpet square permitted to cover floor-mounted flat conductor cable (Type FCC) has been increased to 1.0 m (39.37 in.) square. This will allow the use of standard-sized modular carpet products based on the *International System of Units (SI units)* of measure.

ARTICLE 330 Metal-Clad Cable: Type MC

330.30 Securing and Supporting (Type MC cable)

(B) Securing

Listed Type MC cable with ungrounded conductors 250 kcmil and larger is now permitted to be secured in intervals not exceeding 3 m (10 ft.) for vertical installations.

NEC Language

330.30 Securing and Supporting (Type MC cable)

(B) Securing. Unless otherwise provided, cables shall be secured at intervals not exceeding 1.8 m (6 ft). Cables containing four or fewer conductors sized no larger than 10 AWG shall be secured within 300 mm (12 in.) of every box, cabinet, fitting, or other cable termination.

In vertical installations, listed cables with ungrounded conductors 250 kcmil and larger shall be permitted to be secured at intervals not exceeding 3 m (10 ft).

Comments

The NEC added a new provision at the end of 330.30(B) allowing listed Type MC cable installed in vertical installations to be secured at intervals not exceeding 3 m (10 ft.) where the Type MC cable contains ungrounded conductors 250 kcmil and larger.

Due to the flexibility of this versatile wiring method, Type MC cable is often used for high rise construction installations in lieu of hard conduit.

With Type MC cable typically required to be secured at measurements not exceeding 1.8 m (6 ft), vertical installations with ungrounded conductors 250 kcmil and larger is now permitted to be installed and secured at greater intervals that do not exceeding 3 m (10 ft).

For vertical installations, Type MC cable is one wiring method that can offer the installer an alternative and productive method for commercial vertical installs in high-rise buildings.

Type MC cable with integral conductor supports has been used for quite some time in high-rise construction installations without offsets or directly securing the conductors under the armor.

330.30 Securing and Supporting

(D) Unsupported Cables

(3)

The NEC now permits Type MC cable to be installed unsupported in lengths not exceeding 900 mm (3 ft) where necessary for vibration reasons or flexibility.

NEC Language

330.30 Securing and Supporting

(D) Unsupported Cables

Type MC cable shall be permitted to be unsupported where the cable:

- (1) Is fished between access points through concealed spaces in finished buildings or structures and supporting is impractical; or
- (2) Is not more than 1.8 m (6 ft) in length from the last point of cable support to the point of connection to luminaires or other electrical equipment and the cable and point of connection are within an accessible ceiling. For the purpose of this section, Type MC cable fittings shall be permitted as a means of cable support.
- (3) Is Type MC of the interlocked armor type in lengths not exceeding 900 mm (3 ft) from the last point where it is securely fastened and is used to connect equipment where flexibility is necessary to minimize the transmission of vibration from equipment or to provide flexibility for equipment that requires movement after installation.

Comments

Metal-clad cable (Type MC) is permitted to be unsupported where the cable is fished in concealed spaces in finished buildings or structures and supporting is impractical; or where the cable is not more than 1.8 m (6 ft) in length from the last point of cable support to luminaires or other electrical equipment within an accessible ceiling. There were no provisions for Type MC cable concerning vibration or flexibility issues.

The NEC added a new provision at 330.30(D)(3) permitting Type MC cable to be unsupported where the cable is made of the interlocked armor type in lengths not exceeding 900 mm (3 ft) from the last point of support.

This would apply where flexibility is necessary to minimize the transmission of vibration from equipment or to provide flexibility for equipment that requires movement after installation.

ARTICLE 334 Nonmetallic-Sheathed Cable: Types NM, NMC, and NMS.

334.40 Boxes and Fittings

(B) Devices of Insulating Material

Nonmetallic-sheathed cable interconnectors have been recognized to be used without a box and concealed where used for "repair wiring" rather than "rewiring" in existing buildings.

NEC Language

334.40 Boxes and Fittings

(B) Devices of Insulating Material

Self-contained switches, self-contained receptacles ~~outlet~~, and nonmetallic sheathed cable interconnector ~~tap~~ devices of insulating material that are listed shall be permitted to be used without boxes in exposed cable wiring and for ~~rewiring~~ repair wiring in existing buildings where the cable is concealed ~~and fished~~. Openings in such devices shall form a close fit around the outer covering of the cable, and the device shall fully enclose the part of the cable from which any part of the covering has been removed. Where connections to conductors are by binding screw terminals, there shall be available as many terminals as conductors.

Comments

The NEC revised this subsection to address the specific types of devices that are permitted to be used without boxes.

Listed self-contained switches and listed self-contained receptacles are the devices permitted in this application, not just any switch or outlet.

Listed nonmetallic sheathed cable interconnector devices replaces the term tap devices to zero in on the specific type of device permitted in this application as well. The specific type of situation where this application minus a box is permitted to occur was limited to "repair wiring" rather than "rewiring" in existing buildings where the cable is concealed.

ARTICLE 344 Rigid Metal Conduit: Type RMC

344.2 Definition and 344.100 Construction

Rigid Metal Conduit (RMC) and

344.100 Construction

The NEC revised the definition of *rigid metal conduit* by removing the last two existing sentences and relocating this permitted construction material text to a new 344.100, Construction.

NEC Language

344.2 Definition

Rigid Metal Conduit (RMC)

A threadable raceway of circular cross section designed for the physical protection and routing of conductors and cables and for use as an equipment grounding conductor when installed with its integral or associated coupling and appropriate fittings. ~~RMC is generally made of steel (ferrous) with protective coatings or aluminum (nonferrous). Special use types are red brass and stainless steel.~~

344.100 Construction

RMC shall be made of one of the following:

- (1) Steel (ferrous), with or without protective coatings
- (2) Aluminum (nonferrous)
- (3) Red Brass
- (4) Stainless Steel

Comments

The NEC revised the definition of rigid metal conduit by deleting language that was repetitive by describing types of RMC that are already covered in Article 344 at 344.10, *Uses Permitted*.

The information in 344.10 clarifies the uses permitted for RMC. Additionally, each of the specific types of RMC described at the previous text has special installation requirements according to

the intended use and did not need to be located in a definition in accordance with the NEC Style Manual.

The four types of RMC were also placed in an improved and more user-friendly list format.

ARTICLE 348 Flexible Metal Conduit: Type FMC

348.30 Securing and Supporting

(A) Securely Fastened

Exception No. 4

A revision to **Exception No. 4** for "Securely Fastened" clarifies that listed flexible metal conduit fittings are permitted as a support means for the purpose of applying this exception.

NEC Language

348.30 Securing and Supporting

FMC shall be securely fastened in place and supported in accordance with 348.30(A) and (B).

(A) Securely Fastened

FMC shall be securely fastened in place by an approved means within 300 mm (12 in.) of each box, cabinet, conduit body, or other conduit termination and shall be supported and secured at intervals not to exceed 1.4 m (4 ½ ft).

[Exceptions No. 1 – 3 are unchanged. Please review your copy of the NEC for complete text.]

Exception No. 4: Lengths not exceeding 1.8 m (6 ft) from the last point where the raceway is securely fastened for connections within an accessible ceiling to luminaire(s) or other equipment. For the purposes of this exception, listed flexible metal conduit fittings shall be permitted as a means of support.

Comments

Flexible metal conduit (FMC) is typically required to be securely fastened in place within 300 mm (12 in.) of each box, cabinet, conduit body, etc., and to be supported and secured at intervals not to exceed 1.4 m (4 ½ ft).

There are four exceptions for this rule, with one of these exceptions permitting lengths not exceeding 1.8 m (6 ft) from the last point where the FMC is securely fastened for connections within an accessible ceiling to luminaire(s) or other equipment.

The NEC added a revision to **Exception No. 4** for 348.30(A) to clarify that a flexible metal conduit fitting qualifies as the "last point of support" or as a support means at the luminaire for the purpose of applying **Exception No. 4**.

ARTICLE 350 Liquidtight Flexible Metal Conduit: Type LFMC

350.42 Couplings and Connectors

The NEC now specifies that only fittings listed for use with *liquidtight flexible metal conduit* (LFMC) shall be used with LFMC.

Straight LFMC fittings are permitted for direct burial where marked.

NEC Language

350.42 Couplings and Connectors

Only fittings listed for use with LFMC shall be used. Angle connectors shall not be concealed. Straight LFMC fittings shall be permitted for direct burial where marked.

Comments

The one and only provision at 350.42 stated that angle connectors used with liquidtight flexible metal conduit (LFMC) could not be installed or used where concealed.

The NEC now provides two new provisions at 350.42:

1. A new requirement was added to prohibit any type of fitting other than a fitting listed for use with LFMC from being used with LFMC.
2. The second provision addresses straight fittings for LFMC. These straight fittings are permitted for direct burial, but only those straight fitting marked to indicate they have been identified for direct burial.

It has become somewhat commonplace to see rigid polyvinyl chloride conduit (PVC) fittings such as a PVC connector being used with Liquidtight flexible metal conduit (LFMC).

Because of the close proximity of the inner diameter of the PVC connector to the outside diameter of the LFMC conduit, some installers have been known to use PVC solvent cement to connect these PVC connectors to the end of LFMC conduit. This creates a problem with the inspectors as only LFMC fittings have been evaluated and listed to be used with LFMC conduit.

This change at 350.42 harmonizes coupling and connector requirements for LFMC with the same provisions at 356.42 for liquidtight flexible nonmetallic conduit (LFNC).

Another change at 350.42 aligns the coupling and connector requirements for LFMC with the same provisions at 356.42 for LFNC.

Where marked for the purpose, LFMC is permitted to be used for direct burial, as is LFNC. A new last sentence was added to 350.42 to allow straight LFMC fittings for direct burial where the fitting is so marked.

ARTICLE 356 Liquidtight Flexible Nonmetallic Conduit (LFNC)

356.12 Uses Not Permitted.

A deletion of previous 356.12(4) will no longer limit LFNC to 600 volts and below applications.

NEC Language

Article 356 Liquidtight Flexible Nonmetallic Conduit (LFNC)

356.12 Uses Not Permitted.

LFNC shall not be used as follows:

- (1) Where subject to physical damage

(2) Where any combination of ambient and conductor temperatures is in excess of that for which the LFNC is approved

(3) In lengths longer than 1.8 m (6 ft), except as permitted by 356.10(5) or where a longer length is approved as essential for a required degree of flexibility

~~(4) Where the operating voltage of the contained conductors is in excess of 600 volts, nominal, except as permitted in 600.32(A)~~

~~(5)~~ (4) In any hazardous (classified) location, except as permitted by other articles in this Code.

Comments

The use of liquid tight flexible nonmetallic conduit (LFNC) is limited to areas where the wiring method will not be subject to physical damage.

LFNC is prohibited where ambient and/or conductor temperatures are in excess of that for which the LFNC is approved.

LFNC is generally limited to lengths not longer than 1.8 m (6 ft); and, in general, LFNC is also prohibited in any hazardous (classified) location. For the 2011 NEC, LFNC was prohibited in installations where the operating voltage of the contained conductors was in excess of 600 volts, nominal, except as permitted in 600.32(A) for a sign application.

The deletion of the previous item (4) at 356.12 for "*Uses Not Permitted*" for LFNC allows LFNC as an acceptable wiring method for applications where the voltage involved is greater than 600 volts.

ARTICLE 370 Cablebus

Article 370.1 – 370.120

Article 370, Cablebus, was reorganized to more closely follow the Chapter 3 parallel numbering system format.

NEC Language

Article 370 Cablebus

Part I. General

370.1 Scope

This article covers the use and installation requirements of cablebus and associated fittings.

370.2 Definition.

Cablebus

An assembly of units or sections with insulated conductors having associated fittings forming a structural system used to securely fasten or support conductors and conductor terminations in a completely enclosed, ventilated, protective metal housing. This assembly is designed to carry fault current and to withstand the magnetic forces of such current.

Informational Note: Cablebus is ordinarily assembled at the point of installation from the components furnished or specified by the manufacturer in accordance with instructions for the specific job.

370.1 Scope.

370.2 Definition

Part II. Installation

370.10 Uses Permitted. [Was 370.3 Use.]

Approved cablebus shall be permitted:

- (1) At any voltage or current for which spaced conductors are rated and where installed only for exposed work, except as permitted in 370.18
- (2) For branch circuits, feeders, and services
- (3) To be installed outdoors or in corrosive, wet, or damp locations where identified for the use

370.12 Uses Not Permitted. [Was 370.3 Use.]

Cablebus shall not be permitted to be installed:

- (1) In hoistways
- (2) In hazardous (classified) locations, unless specifically approved for the use

370.18 Cablebus Installation. [Was 370.6 Support and Extension Through Walls and Floors.]

(A) Transversely Routed. [Was 370.6(B)]

Cablebus shall be permitted to extend transversely through partitions or walls, other than fire walls, provided that the section within the wall is continuous, protected against physical damage, and unventilated.

(B) Through Dry Floors and Platforms. [Was 370.6(C)]

Except where firestops are required, cablebus shall be permitted to extend vertically through dry floors and platforms, provided that the cablebus is totally enclosed at the point where it passes through the floor or platform and for a distance of 1.8 m (6 ft) above the floor or platform.

(C) Through Floors and Platforms in Wet Locations. [Was 370.6(D)] **370.20 Conductor Size and Termination.** [Was 370.4 and 370.8]

Except where firestops are required, cablebus shall be permitted to extend vertically through floors and platforms in wet locations where:

- (1) There are curbs or other suitable means to prevent waterflow through the floor or platform opening, and
- (2) Where the cablebus is totally enclosed at the point where it passes through the floor or platform and for a distance of 1.8 m (6 ft) above the floor or platform.

370.20 Conductor Size and Termination

(A) Conductors. [Was 370.4(A) Types of Conductors.]

The current-carrying conductors in cablebus shall:

- (1) Have an insulation rating of 75°C (167°F) or higher and be of an approved type suitable for the application.
- (2) Be sized in accordance with the design of the cablebus but in no case be smaller than 1/0.

(B) Termination. [Was 370.8 Conductor Terminations]

Approved terminating means shall be used for connections to cablebus conductors.

370.22 Number of Conductors. [Was 370.4(C) Size and Number of Conductors.]

The number of conductors shall be that for which the cablebus is designed.

370.23 Overcurrent Protection. [Was 370.5]

Cablebus shall be protected against overcurrent in accordance with the allowable ampacity of the cablebus conductors in accordance with 240.4.

Exception: Overcurrent protection shall be permitted in accordance with 240.100 and 240.101 for over 1000 volts, nominal.

370.30 Securing and Supporting. [New]

(A) Cablebus Supports. [Was 370.6(A) Support.]

Cablebus shall be securely supported at intervals not exceeding 3.7 m (12 ft). Where spans longer than 3.7 m (12 ft) are required, the structure shall be specifically designed for the required span length.

(B) Conductor Supports. [Was 370.4(D)]

The insulated conductors shall be supported on blocks or other identified mounting means. The individual conductors in a cablebus shall be supported at intervals not greater than 900 mm (3 ft) for horizontal runs and 450 mm (1½ ft) for vertical runs. Vertical and horizontal spacing between supported conductors shall be not less than one conductor diameter at the points of support.

370.42 Fittings. [Was 370.7]

A cablebus system shall include approved fittings for the following:

- (1) Changes in horizontal or vertical direction of the run
- (2) Dead ends
- (3) Terminations in or on connected apparatus or equipment or the enclosures for such equipment
- (4) Additional physical protection where required, such as guards where subject to severe physical damage

370.60 Grounding. [Was 370.3 Use and 370.9 Grounding.]

A cablebus system shall be grounded and/or bonded as applicable:

- (1) Cablebus framework, where bonded, shall be permitted to be used as the equipment grounding conductor for branch circuits and feeders.
- (2) A cablebus installation shall be grounded and bonded in accordance with Article 250, excluding 250.86, Exception No. 2.

370.80 Ampacity of Conductors. [Was 370.4(B)]

The ampacity of conductors in cablebus shall be in accordance with Table 310.15(B)(17) and Table 310.15(B)(19) for installations up to and including 2000 volts, or with Table 310.60(C)(69) and Table 310.60(C)(70) for installations 2001 to 35,000 volts.

Part III. Construction Specifications

370.120 Marking. [Was 370.10]

Each section of cablebus shall be marked with the manufacturer's name or trade designation and the maximum diameter, number, voltage rating, and ampacity of the conductors to be installed. Markings shall be located so as to be visible after installation.

ARTICLE 376 Metal Wireways

376.22 Number of Conductors and Ampacity

B) Adjustment Factors

Ampacity adjustment factors for more than three current-carrying conductors in a raceway shall only apply to metal wireways where the number of current-carrying conductors exceeds 30 at any cross section of the wireway.

NEC Language

376.22 Number of Conductors and Ampacity

The number of conductors and their ampacity shall comply with 376.22(A) and (B).

A) Cross-Sectional Areas of Wireway

The sum of the cross sectional areas of all contained conductors at any cross section of a wireway shall not exceed 20 percent of the interior cross-sectional area of the wireway.

(B) Adjustment Factors

The adjustment factors in 310.15(B)(3)(a) shall be applied only where the number of current-carrying conductors, including neutral conductors classified as current carrying under the provisions of 310.15(B)(5), exceeds 30 at any cross section of the wireway.

Conductors for signaling circuits or controller conductors between a motor and its starter and used only for starting duty shall not be considered as current carrying conductors.

Comments

The "30 current-carrying conductors" in question were identified as 30 current-carrying conductors at any cross section of the wireway — not just 30 or more current-carrying conductors total in the wireway.

A revision to 376.22(B) clarifies that adjustment factors of 310.15(B)(3) only apply where the number of current-carrying conductors exceeds 30 at any cross sectional area of the wireway, as opposed to 30 conductors as a total number in the wireway itself.

376.56 Splices, Taps, and Power Distribution Blocks

(B) Power Distribution Blocks.

(1) Installation

(5) Conductors

The NEC now states that power distribution blocks installed in wireways ahead of the service main (line side) must be *listed for the purpose*.

Also, conductors in wireways are required to be arranged so that power distribution block terminals are unobstructed after their installation.

NEC Language

376.56 Splices, Taps, and Power Distribution Blocks

(B) Power Distribution Blocks.

(1) Installation

Power distribution blocks installed in metal wireways shall be listed. Power distribution blocks installed on the line side of the service equipment shall be listed for the purpose.

(2) Size of Enclosure. (Text unchanged)

(3) Wire Bending Space. (Text unchanged)

(4) Live Parts. (Text unchanged)

(5) Conductors

Conductors shall be arranged so the power distribution block terminals are unobstructed following installation.

Comments

In addition to the requirements for power distribution blocks (PDB) required in the 2011 NEC, two new provisions were added to these requirements.

The NEC added a new sentence to item (1) requiring PDBs installed ahead of the service main (line side) to be listed for the purpose. The second change occurred by adding a new 376.56(B)(5) which requires PDBs installed in metal wireways to have all conductors arranged so that PDB terminals remain accessible and unobstructed after installation.

ARTICLE 386 Surface Metal Raceways

386.120 Marking

Surface metal raceways are now required to have each length identified and marked according to 110.21(A) [manufacturer's marking requirements].

NEC Language

Article 386 Surface Metal Raceways

386.120 Marking

Each length of surface metal raceways shall be clearly and durably identified as required in the first sentence of 110.21.

Comments

Surface metal raceway is defined at 386.2 as "a metallic raceway that is intended to be mounted to the surface of a structure, with associated couplings, connectors, boxes, and fittings for the installation of electrical conductors."

The NEC added a new product marking requirement at 386.120 for surface metal raceway. The addition of this new requirement provides consistency with other articles within the Code for similar products.

ARTICLE 392 Cable Trays

392.10 Uses Permitted

The NEC revised Table 392.10(A) to reflect and clarify the permitted wiring methods that can be used in cable trays.

NEC Language

Article 392 Cable Trays

392.10 Uses Permitted

Cable tray shall be permitted to be used as a support system for service conductors, feeders, branch circuits, communications circuits, control circuits, and signaling circuits. Cable tray installations shall not be limited to industrial establishments. Where exposed to direct rays of the sun, insulated conductors and jacketed cables shall be identified as being sunlight-resistant.

Cable trays and their associated fittings shall be identified for the intended use.

(A) Wiring Methods

The wiring methods in Table 392.10(A) shall be permitted to be installed in cable tray systems under the conditions described in their respective articles and sections.

(Please see your copy of the NEC for the complete table text and revised Table 392.10(A) provided here.)

Table 392.10(A) Wiring Methods (Cable Trays)	
Wiring Method	Article
Armored cable: Type AC	320
CATV cables	820
Class 2 and Class 3 cables	725
Communication cables	725, 770, and 800
Communication raceways	800
Electrical metallic tubing: Type EMT	358
Electrical nonmetallic tubing: Type ENT	362
Fire alarm cables	760
Flexible metal conduit: Type FMC	348
Flexible metallic tubing: Type FMT	360
Instrumentation tray cable: Type ITC	727
Intermediate metal conduit: Type IMC	342
Liquidtight flexible metal conduit: Type LFMC	350
Liquidtight flexible nonmetallic conduit: Type LFNC	356
Metal-clad cable: Type MC	330
Mineral-insulated, metal-sheathed cable: Type MI	332
Network-powered broadband communication cable	830
Nonmetallic-sheathed cable: Types NM, NMC and NMS	334
Non-powered-limited fire alarm cable	760
Optical fiber cables	770
Optical fiber raceways	770
Other factory-assembled, multiconductor control, signal, or power cables that are specifically approved for the installation in cable trays	
Power and control tray cable: Type TC	336
Power-limited fire alarm cable	760
Power-limited tray cable	760
Rigid metal conduit: Type RMC	344
Rigid nonmetallic conduit	352
Rigid polyvinyl chloride PVC conduit: Type PVC	352
Reinforced thermosetting resin conduit: Type RTRC	355
Multiconductor Service-entrance cable: Types SE and USE	338
Signaling raceways	725
Multiconductor Underground feeder and branch-circuit cable: Type UF	340

Source: NEC 2014

Comments

The NEC revised Table 392.10(A) with no substantial technical changes.

The changes were more editorial in nature to properly identify the permitted wiring methods that can be supported by a cable tray.

The common wiring method abbreviations were added to the end of the wiring methods where appropriate.

392.18 Cable Tray Installation

(H) Marking

Exception

The NEC relaxed the marking requirement for cable trays containing conductors rated over 600 volts for industrial establishments with maintenance, supervision, and qualified persons servicing the installation.

NEC Language

392.18 Cable Tray Installation

(H) Marking

Cable trays containing conductors rated over 600 volts shall have a permanent, legible warning notice carrying the wording "DANGER — HIGH VOLTAGE — KEEP AWAY" placed in a readily visible position on all cable trays, with the spacing of warning notices not to exceed 3 m (10 ft). The danger marking(s) or labels shall comply with 110.21(B).

Exception: Where not accessible (as applied to equipment), in industrial establishments where the conditions of maintenance and supervision ensure that only qualified persons service the installation, cable tray system warning notices shall be located where necessary for the installation to assure safe maintenance and operation.

Comments

In industrial establishments where the conditions of maintenance and supervision ensure that only qualified persons service the installation, cable tray system warning labels are not required for the installation of cable trays containing conductors rated over 600 volts where the cable tray is not accessible (as applied to equipment).

The NEC added a tag line at the end of the main rule at 392.18(H) directing installers to the new warning and danger label requirements at 110.21(B). The remainder of the 392.18 installation requirements for cable trays remained the same.

392.20 Cable and Conductor Installation

(A) Multiconductor Cable Rated Operating at 600 Volts or Less and

(B) Cables Rated Operating at Over 600 Volts

The NEC now states that cables installed in cable trays will be based upon the operating voltage and not the cable rating.

NEC Language

392.20 Cable and Conductor Installation

(A) Multiconductor Cable Rated Operating at 600 Volts or Less

Multiconductor cables ~~rated~~ operating at 600 volts or less shall be permitted to be installed in the same cable tray.

(B) Cables ~~Rated~~ Operating at Over 600 Volts

Cables rated operating at over 600 volts and those ~~rated~~ operating at 600 volts or less installed in the same cable tray shall comply with either of the following:

(1) The cables ~~rated operating at~~ over 600 volts are Type MC.

(2) The cables ~~rated~~ operating at over 600 volts are separated from the cables ~~rated~~ operating at 600 volts or less by a solid fixed barrier of a material compatible with the cable tray.

Comments

Cables rated 600 volts or less were permitted to be installed in the same cable tray as cables rated over 600 volts. However, cables rated over 600 volts had to meet one of two options:

- One was that the cables rated over 600 volts had to be of Type MC construction.
- The second was that cables rated over 600 volts had to be separated from the cables rated 600 volts or less by a solid fixed barrier within the cable tray.

The word "rated" was replaced with the words "operating at" eight times within these two subsections. These revisions clarify that cables installed in cable trays should be based upon the operating voltage rather than the actual rating of the cable.

The previous language at 392.20 based all installations of cables in cable trays on insulation rating of the conductors or cables involved.

NEC 300.3(C) permits conductors installed in raceways to be chosen based on the insulation rating of any of the conductors involved being equal to at least the maximum circuit voltage applied to any conductor within the enclosure, cable, or raceway, rather than the insulation rating itself.

This change at 392.20 brings the same provisions for conductors installed in raceway as those installed in a cable tray.

There are times when cables rated over 600 volts are available for less than 600-volt system circuit or feeder installations. This revision will now make this practice acceptable.

ARTICLE 393 - Low-Voltage Suspended Ceiling Power Distribution Systems

Article 393.1 – 393.104

A new article was added to address low-voltage Class 2 equipment connected to ceiling grids and walls constructed for this purpose.

NEC Language

Article 393 - Low-Voltage Suspended Ceiling Power Distribution Systems

Part I. General

393.1 Scope.

393.2 Definitions.

393.6 Listing Requirements.

(A) Listed System.

(B) Assembly of Listed Parts.

Part II. Installation

393.10 Uses Permitted.

393.12 Uses Not Permitted.

393.14 Installation.

(A) General Requirements.

(B) Insulated Conductors.

393.21 Disconnecting Means.

(A) Location.

(B) Multiwire Branch Circuits.

393.30 Securing and Supporting.

(A) Attached to Building Structure.

(B) Attachment of Power Grid Rails.

393.40 Connectors and Enclosures.

(A) Connectors.

(B) Enclosures.

393.45 Overcurrent and Reverse Polarity (Backfeed) Protection.

(A) Overcurrent Protection.

(B) Interconnection of Power Sources.

(C) Reverse Polarity (Backfeed) Protection of Direct-Current Systems.

393.56 Splices.

393.57 Connections.

393.60 Grounding.

(A) Grounding of Supply Side of Class 2 Power Source.

(B) Grounding of Load Side of Class 2 Power Source.

Part III. Construction Specifications

393.104 Sizes and Types of Conductors.

(A) Load Side Utilization Conductor Size.

(B) Power Feed Bus Rail Conductor Size.

(Due to the size of this Article, please see your copy of the NEC for the complete text)

Comments

The NEC added a new article entitled "Low-Voltage Suspended Ceiling Power Distribution Systems" was added to address low-voltage Class 2 supplied equipment (lighting and power) connected to ceiling grids, floors and walls built for this purpose.

This article addresses equipment with similar characteristics to track lighting but includes the wiring and power supply requirements.

This type of low-voltage suspended ceiling power distribution system is defined as "a system that serves as a support for a finished ceiling surface and consists of a busbar and busbar support system to distribute power to utilization equipment supplied by a Class 2 power supply."

The growing interest in alternative energy sources (e.g., photovoltaics, wind turbines, batteries, fuel cells, etc.) and in the proliferation of low-voltage, low-power devices (sensors, LV lighting, IT equipment, AV equipment, etc.) has created a significant need for adequate language supporting the practical safeguarding of circuits and electrical equipment operating at 30 volts ac or 60 volts dc or less.

This article addresses equipment with similar characteristics to track lighting but includes the wiring and power supply requirements as well. The article provides the specific requirements for the safe installation of low-voltage, power-limited power distribution providing power to lighting and non-lighting loads.

ARTICLE 399 Outdoor Overhead Conductors over 1000 Volts

399.2 Definition. (Outdoor Overhead Conductors over 1000 Volts)

Outdoor Overhead Conductors

The NEC revised the definition of *Outdoor Overhead Conductors* to include the words "in free air" to ensure that the definition clearly indicated that wiring installed under the scope of Article 399 was not installed in raceways, etc.

NEC Language

399.2 Definition. (Outdoor Overhead Conductors over ~~600~~ 1000 Volts)

Outdoor Overhead Conductors

Single conductors, insulated, covered, or bare, installed outdoors on support structures in free air.

Comments

The definition of an over-600-volt outdoor overhead conductor as it applied to Article 399 was "*Single conductors, insulated, covered, or bare, installed outdoors on support structures.*"

The NEC added the words "in free air" to the definition of outdoor overhead conductors as applied to Article 399, which now involves outdoor overhead conductors rated over 1000 volts due to the global changes pertaining to the 1000 volts parameter in the 2014 NEC.

Conclusion

Summary

You have completed Chapter 3 of this course on *Changes in the 2014 NEC*.

Resources

References

NFPA. *2014 National Electrical Code (NEC)*, 2013.

International Association of Electrical Inspectors, Richardson, Texas and National Fire Protection Association, Inc. Quincy, MA. *Analysis of Changes – NEC 2014*, 2013.

The designations "National Electrical Code" and "NEC" refer to NFPA 70, National Electrical Code, which is a registered trademark of the National Fire Protection Association.

Author Biography

Neal L. Burdick

Neal Burdick has over 30 years of experience and is currently a construction inspector for the City of Tampa. He is a registered instructor for the Electrical Council of Florida and is the author and instructor of a State of Florida approved Electrical Contractor's Licensing Board course.

Neal is an accomplished and exceptionally knowledgeable professional with a solid background in electrical and building inspections, as well as code compliance. He is recognized as an expert in this industry. He is an active member of IAEI, BOAF, ECF, and related industry associations. Mr. Burdick conducts training to building officials, engineers, plans examiners, inspectors, electrical contractors, and apprentices throughout the State of Florida.



2014 NEC Changes - Chapter 4: Equipment for General Use

Table of Contents

Introduction	4
Course Overview	4
Learning Objectives	4
ARTICLE 400 Flexible Cords and Cables	6
400.1 Scope & 400.4 Types (Flexible Cords and Cables)	6
400.5 Ampacities for Flexible Cords and Cables	6
400.6 Markings	7
400.7 Uses Permitted	8
ARTICLE 404 Switches	10
404.1 Scope & 404.2 Switch Connections	10
404.8 Accessibility and Grouping	12
ARTICLE 406 Receptacles, Cord Connectors, and Attachment Plugs (Caps)	12
406.1 Scope & 406.3 Receptacle Rating and Type	12
406.4 General Installation Requirements	14
406.5 Receptacle Mounting	15
406.9 Receptacles in Damp or Wet Locations	17
406.12 Tamper-Resistant Receptacles	18
406.15 Dimmer Controlled Receptacles	18
Article 408 Switchboards, Switchgear, and Panelboards	19
408.1 Scope & 408.3 Support and Arrangement of Busbars and Conductors	19
408.4 Field Identification Required	20
408.55 Wire-Bending Space Within an Enclosure Containing a Panelboard	21
ARTICLE 409 Industrial Control Panels	22
409.1 Scope & 409.20 Conductor – Minimum Size and Ampacity. (Industrial Control Panels)	22
ARTICLE 410 Luminaires, Lampholders, and Lamps	23
410.1 Scope & 410.6 Listing Required	23
410.10 Luminaires in Specific Locations	23
410.130 General. (Electric Discharge Lighting Systems of 1000 Volts or Less)	24
ARTICLE 422 Appliances	25
422.1 Scope & 422.5 Ground-Fault Circuit-Interrupter (GFCI) Protection	25
422.11 Overcurrent Protection	26

- 422.23 Tire Inflation and Automotive Vacuum Machines27
- 422.49 High-Pressure Spray Washers.....28
- 422.51 Cord-and-Plug-Connected Vending Machines29
- ARTICLE 424 Fixed Electric Space-Heating Equipment30
 - 424.1 Scope & 424.19 Disconnecting Means. (Fixed Electric Space-Heating Equipment).....30
 - 424.66 Installations.....30
- ARTICLE 430 Motors, Motor Circuits, and Controllers32
 - 430.1 Scope & 430.22 Single Motor32
 - 430.52 Rating or Setting for Individual Motor Circuit.....33
 - 430.53 Several Motors or Loads on One Branch Circuit34
 - 430.233 Guards for Attendants.....36
- ARTICLE 440 Air-Conditioning and Refrigerating Equipment.....36
 - 440.1 Scope & 440.9 Grounding and Bonding.....36
- ARTICLE 445 Generators37
 - 445.1 Scope & 445.11 Marking.....37
 - 445.18 Disconnecting Means Required for Generators38
 - 445.20 Ground-Fault Circuit-Interrupter Protection for Receptacles on 15-kW or Smaller, Portable Generators39
- ARTICLE 450 Transformers and Transformer Vaults (Including Secondary Ties)40
 - 450.1 Scope & 450.10 Grounding.....40
 - 450.11 Marking.....41
- Article 480 Storage Batteries.....42
 - 480.1 to 480.1042
- ARTICLE 490 Equipment Over 1000 Volts, Nominal.....43
 - 490.1 Scope & 490.48 Substations.....43
- Conclusion44
 - Summary.....44
- Resources.....45
 - References45
- Author Biography46
 - Neal L. Burdick46

Introduction

Course Overview

This is the fourth of several courses covering the changes in the 2014 edition of the National Electrical Code (NEC) created by the NFPA. The 2014 NEC provides an accurate, reliable, and authoritative account of the hundreds of significant revisions in the 2014 Code.

This Course provides coverage of significant changes in the 2014 National Electrical Code. With every new edition of the NEC, some of the changes include new requirements to sections, while some of the changes include entirely new articles. Some changes are revisions to existing requirements while others are deletions to some existing requirements.

Although not required, it is **recommended to have a copy of the 2014 NEC manual for reference**, especially when reviewing information in large tables.

A Summary of each change is followed by the actual NEC Language, with deletions showing with a strikethrough and additions/changes (highlighted in yellow). When necessary, Comments are added to appropriate topics.

In many cases, paragraphs not directly affected by a change are retained to preserve context. There will be no quiz questions on material that does not cover changes in the 2014 NEC.

The length of each segment varies depending on the topic and material available.

The National Electrical Code is intended for electricians and subcontractors, electrical inspectors, electrical engineers, designers, and other qualified persons who understand electrical currents, theory, safety procedures, and electrical trade practices. The code does not serve as a teaching manual for untrained individuals.

Learning Objectives

By the end of this course, you will be able to:

- Identify the various significant changes in *Chapter 4* of the NEC
- Recognize that this NEC contains provisions that are considered necessary for safety and compliance therewith and proper maintenance results in an installation that is essentially free from hazard.
- Refer to the appropriate sections of the code and find applicable changes and information
- Describe the NEC code for safety requirements on flexible cords and cable tags
- Identify the NEC code for safe installation of switch controlled lighting loads
- List the options for safely replacing an existing receptacle when an equipment grounding conductor does not exist

2014 NEC Changes - Chapter 4: Equipment for General Use

- Identify the change to the placement of GFCI devices on appliances
- Explain the new safety requirements for the installation of duct heaters with limited access
- List the safety information that are required for transformers

ARTICLE 400 Flexible Cords and Cables

400.1 Scope & 400.4 Types (Flexible Cords and Cables)

This article covers general requirements, applications, and construction specifications for flexible cords and flexible cables.

Changed From NEC 2011

The use of flexible cords and flexible cables not described in Table 400.4 and now requires the permission of the *Authority Having Jurisdiction AHJ*.

NEC Language

400.4 Types (Flexible Cords and Cables)

~~The use of flexible cords and flexible cables shall conform to the description~~ other than those in Table 400.4 shall require permission by the authority having jurisdiction.

~~Types of flexible cords and flexible cables other than those listed in the table shall be the subject of special investigation.~~

Comments

The use of flexible cords and flexible cables was limited to those identified by Table 400.4. Any flexible cord or cable, other than those listed in the table, was to be the "subject of special investigation."

A revision to 400.4 relaxed the rule for the use of flexible cords and flexible cables, other than those in Table 400.4, to require "*permission by the authority having jurisdiction*" rather than requiring these flexible cords and cables to be the "*subject of special investigation*."

The *Authority Having Jurisdiction (AHJ)* is the person or organization that is responsible for enforcing the requirements of the Code or for "approving" equipment, materials, an installation, or a procedure.

400.5 Ampacities for Flexible Cords and Cables

(A) Ampacity Tables.

Temperature correction factors now apply to ampacity values for flexible cords and cables in both Table 400.5(A)(1) and Table 400.5(A)(2).

NEC Language

400.5 Ampacities for Flexible Cords and Cables

(A) Ampacity Tables.

Table 400.5(A)(1) provides the allowable ampacities, and Table 400.5(A)(2) provides the ampacities for flexible cords and cables with not more than three current-carrying conductors. These tables shall be used in conjunction with applicable end-use product standards to ensure selection of the proper size and type. Where cords and cables are used in ambient temperatures other than 30°C (86°F), the temperature correction factors from Table 310.15(B)(2)

(a) that correspond to temperature rating of the cord or cable shall be applied to the ampacity in Table 400.5(A)(1) and Table 400.5(A)(2).

Cords and cables rated 105°C shall use correction factors in 90°C column of Table 310.15(B)(2)(a) for temperature correction. Where the number of current-carrying conductors exceeds three, the allowable ampacity or the ampacity of each conductor shall be reduced from the 3-conductor rating as shown in Table 400.5(A)(3).

(The remainder of 400.5(A) text is unchanged. Please use your copy of the NEC for the complete text.)

Comments

The previous language for ampacity tables and possible temperature correction factors for flexible cords and cables literally only applied to flexible cords and Table 400.5(A)(2). The previous language indicated that these provisions did not apply to flexible cables or to Table 400.5(A)(1).

If temperature correction factors from Table 310.15(B)(2)(a) warrant being applied, there should be no difference in flexible cords or flexible cables. These temperature correction factors should apply to the ampacity values for both Table 400.5(A)(1) and Table 400.5(A)(2).

The *NEC Code-Making Panel (CMP-6)* also added a sentence dealing with the use of correction factors for 105°C cords and cables as Table 310.15(B)(2)(a) does not include 105°C correction factors. In the absence of these values, 400.5(A) now indicates that it would be appropriate to use the ampacity values in the 90°C column from Table 310.15(B)(2)(a).

400.6 Markings

(A) Standard Markings

The NEC now requires standard marking requirements for flexible cords and cables to include the maximum operating temperature of the flexible cord or cable.

NEC Language

400.6 Markings

(A) Standard Markings

Flexible cords and cables shall be marked by means of a printed tag attached to the coil reel or carton.

The tag shall contain the information required in 310.120(A). Types S, SC, SCE, SCT, SE, SEO, SEOO, SJ, SJE, SJEO, SJEOO, SJO, SJT, SJTO, SJTOO, SO, SOO, ST, STO, STOO, SEW, SEOW, SEOOW, SJEW, SJEOW, SJEOWW, SJOW, SJTW, SJTOW, SJTOOW, SOW, SOOW, STW, STOW, and STOOW flexible cords and G, G-GC, PPE, and W flexible cables shall be durably marked on the surface at intervals not exceeding 610 mm (24 in.) with the type designation, size, and number of conductors.

Required markings on tags, cords and cables shall also include the maximum operating temperature of the flexible cord or cable.

Comments

The NEC requires flexible cords and cables to be marked by means of a printed tag attached to the coil reel or carton.

This tag is required to identify:

1. The maximum rated voltage
2. The proper type letter or letters for the type of wire or cable involved
3. The manufacturer's name, trademark, or other distinctive marking
4. Where the neutral conductor is smaller than the ungrounded conductors, and
5. The AWG size or circular mil area.

For most flexible cords or cables, the cord or cable is required to be durably marked on the surface at intervals not exceeding 610 mm (24 in.) with the type letter designation, size, and number of conductors.

In addition to the standard marking requirements required in the previous Code, the 2014 NEC added a new requirement to require flexible cords and cables or their associated tags to also include the maximum operating temperature of the flexible cord or cable.

Listed cords or cables may include a temperature marking, but not all flexible cords are required to be listed. With the maximum operating temperature marked on the flexible cord or cable, it would then be possible for an end user of this product to calculate the ampacity of a cord or cable in an ambient temperature if other than 30°C (86° F).

400.7 Uses Permitted

(A) Uses

The NEC now permits a flexible cord between an existing receptacle outlet and an inlet, where the inlet provides power to an additional single receptacle outlet as a listed assembly.

NEC Language

400.7 Uses Permitted

(A) Uses

Flexible cords and cables shall be used only for the following:

[Items (1) through (10) unchanged.]

(Please use your copy of the NEC for the complete text)

(11) Between an existing receptacle outlet and an inlet, where the inlet provides power to an additional single receptacle outlet. The wiring interconnecting the inlet to the single receptacle outlet shall be a Chapter 3 wiring method. The inlet, receptacle outlet, and Chapter 3 wiring method, including the flexible cord and fittings, shall be a listed assembly specific for this application.

Comments

Flexible cords and cables are permitted to be used with or for:

1. Pendants
2. Wiring of luminaires
3. Connection of portable luminaires
4. Portable and mobile signs
5. Appliances
6. Elevator cables
7. Wiring of cranes and hoists
8. Connection of utilization equipment to facilitate frequent interchange, prevention of the transmission of noise or vibration
9. Appliances where designed to permit ready removal and the appliance is intended or identified for flexible cord connection, connection of moving parts, and where specifically permitted elsewhere in the Code.

The 2014 NEC added a new provision allowing a flexible cord to be used between an existing receptacle outlet and an inlet, where the inlet provides power to an additional single receptacle outlet.

Part of this new allowance requires the wiring interconnecting the inlet to the single receptacle outlet to be a Chapter 3 wiring method.

The inlet, receptacle outlet, and Chapter 3 wiring method, including the flexible cord and fittings, must be a "listed assembly" specific for this application.

This new provision is designed to allow newer and identified products primarily used for flat-screen televisions mounted on a wall. These products come as a listed assembly designed for this purpose.

These listed assemblies typically come with a short flexible cord with a male cord cap to plug into an existing 120-volt receptacle outlet. The other end is typically a female cord cap designed to plug on to a male inlet outlet device that is part of the listed assembly.

- A 2.1 m (7 ft) nonmetallic-sheathed cable assembly is typically provided to connect from the inlet to a single inlet receptacle outlet located behind the wall-mounted flat-screen television.
- This 2.1 m (7 ft) nonmetallic-sheathed cable assembly is designed to be fished in the wall behind the finished wall surface and is provided with a nonmetallic-sheathed cable interconnector device in the middle of the assembly.

These products are listed as an assembly, but there was no code language in the NEC that allowed the flexible cord from the existing receptacle outlet to the inlet device.

The wiring in the wall from the inlet to the single receptacle outlet behind the flat-screen television would not be connected to the wiring system of the building, but would be energized only when the provided flexible cord (similar to a computer monitor power cord) is utilized to energize the listed flanged inlet.

These products are typically listed with two sets of cords (with a Type NM interconnector device) and both flanged inlet and single outlet receptacle.

Without this new "Uses Permitted" provision, 400.8(1) could easily be interpreted by the AHJ as disallowing the use of this type of system as flexible cords or cables are not permitted as a substitute for the fixed wiring of a structure.

The addition of 400.7(A)(11) removes any ambiguity and clearly allows these listed assemblies for powering and protecting the receptacle outlet used to energize a wall-mounted flat-screen television and other similar equipment.

ARTICLE 404 Switches

404.1 Scope & 404.2 Switch Connections

The provisions of this article apply to all switches, switching devices, and circuit breakers used as switches operating at 1000 volts and below, unless specifically referenced elsewhere in this *Code* for higher voltages.

(C) Switched Controlling Lighting Loads

The NEC revised requirements and exceptions for the grounded conductor at switching locations into positive text and rearranged into a list format.

NEC Language

404.2 Switch Connections

(C) Switched Controlling Lighting Loads

The grounded circuit conductor for the controlled lighting circuit shall be provided at the switch location where switches control lighting loads that are supplied by a grounded general purpose branch circuit for other than the following:

1. Where conductors ~~for switches controlling lighting loads~~ enter the box enclosing the switch through a raceway, provided that the raceway is large enough for all contained conductors, including a grounded conductor. ~~The raceway shall have sufficient cross-sectional area to accommodate the extension of the grounded circuit conductor of the lighting circuit to the switch location whether or not the conductors in the raceway are required to be increased in size to comply with 310.15(B)(3)(a).~~

Here is the cleaned up paragraph:

1. Where conductors enter the box enclosing the switch through a raceway, provided that the raceway is large enough for all contained conductors, including a grounded conductor
2. Where the box enclosing the switch is accessible for the installation of an additional or replacement cable without removing finish materials. ~~Cable assemblies for switches controlling lighting loads enter the box through a framing cavity that is open at the top or bottom on the same floor level, or through a wall, floor, or ceiling that is unfinished on one side.~~
3. Snap switches with integral enclosures complying with 300.15(E).
4. Where a switch does not serve a habitable room or bathroom.
5. Where multiple switch locations control the same lighting load such that the entire floor area of that room or space is visible from the single or combined switch locations.
6. Where lighting in the area is controlled by automatic means.
7. A switch controlling a receptacle load.

Comments

A grounded conductor was previously required at every switch location where switches control lighting loads supplied by a grounded general purpose branch circuit.

This main rule had an exception with two specific conditions:

1. The first exception permitted the grounded circuit conductor to be omitted from the switch enclosure where the wiring method employed was raceway systems that allow the grounded conductor to be added to the switch location at a later date, when and if needed. The raceway had to be of sufficient cross-sectional area to accommodate the addition of the grounded circuit conductor of the lighting circuit to the switch location.

2. The other exception dealt with cable assemblies entering the switch box through a framing cavity that was open at the top or bottom on the same floor level, or through a wall, floor, or ceiling that is unfinished on one side.

The 2014 NEC revised this subsection and the exception to incorporate the exception (with two conditions) into positive text and to arrange the conditions to which a grounded conductor would not be required at the switch location into a simpler-to-use list format.

The NEC also added five new conditions along with two existing conditions described in the previous exception.

404.8 Accessibility and Grouping

(C) Multipole Snap Switches

The 2014 NEC no longer permits multipole snap switches that are rated not less than the system voltage (whether listed for multiple circuits or not) to be fed from more than a single circuit.

NEC Language

404.8 Accessibility and Grouping

(C) Multipole Snap Switches

A multipole, general-use snap switch shall not be permitted to be fed from more than a single circuit unless it is listed and marked as a two-circuit or three-circuit switch. ~~— or unless its voltage rating is not less than the nominal line-to-line voltage of the system supplying the circuits.~~

Comments

Previous language at 404.8(C) allowed a general-use multipole snap switch for multi-circuit applications.

Listed 2- and 3-pole general-use snap switches have not been evaluated for use in multi-circuit applications.

The basic requirement for safety as stated in the initial sentence of 404.8(C) that multipole, general-use snap switches shall not be supplied from more than one circuit unless “listed and marked as a two-circuit or three-circuit switch.” This is the only safe use of these products.

ARTICLE 406 Receptacles, Cord Connectors, and Attachment Plugs (Caps)

406.1 Scope & 406.3 Receptacle Rating and Type

This article covers the rating, type, and installation of receptacles, cord connectors, and attachment plugs (cord caps).

(E) Controlled Receptacle Marking

The NEC now requires a new marking symbol for receptacle outlets controlled by an automatic control device or by an automatic energy management system.

The new requirement includes new Figure 406.3(E).

NEC Language

406.3 Receptacle Rating and Type

(E) Controlled Receptacle Marking

All nonlocking-type, 125-volt, 15- and 20-ampere receptacles that are controlled by an automatic control device or incorporate control features that remove power from the outlet for the purpose of energy management or building automation shall be marked with the symbol shown below placed on the controlled receptacle outlet where visible after installation.



Figure 406.3(E) Controlled Receptacle Marking Symbol.

Exception: The marking is not required for receptacles controlled by a wall switch as permitted by 210.70 to provide the required room lighting outlets.

Comments

The 2014 NEC now requires a new marking symbol for receptacle outlets controlled by an automatic control device or by an automatic energy management system.

The new symbol is displayed in Figure 406.3(E) above.

An exception to this rule indicates that this marking is not required for receptacle outlets controlled by a wall switch to provide the required room lighting outlet(s) as permitted by 210.70(A)(1) Ex. No. 1.

New energy management codes are currently being widely adopted. One such energy management code is ASHRAE 90.1 *Energy Standard for Buildings Except Low-Rise Residential Buildings*. This code requires that up to 50 percent of all 125-volt, 15- and 20-ampere receptacles be automatically controlled. The control could be an energy management system, a timer or a sensor.

The occupant or end user needs to know which receptacle outlets will be automatically controlled and which receptacles will be energized continually. This will avoid plugging in loads, such as a refrigerator or appliance, and being unintentionally turned off for a period of time.

Automated systems typically control identified loads such as lighting or HVAC equipment, with the consequences known and understood.

The uncertainty of what is plugged into a controlled receptacle outlet can raise concerns regarding safety as well as convenience; thus it is important to be able to readily identify receptacle outlets that will be automatically powered on and off.

406.4 General Installation Requirements

The NEC now requires AFCI- and GFCI-type replacement receptacles to be installed in a readily accessible location.

NEC Language

406.4 General Installation Requirements

Receptacle outlets shall be located in branch circuits in accordance with Part III of Article 210.

General installation requirements shall be in accordance with 406.4(A) through (F).

(D) Replacements

Replacement of receptacles shall comply with 406.4(D)(1) through (D)(6), as applicable. Arc-fault circuit-interrupter and ground-fault circuit-interrupter type receptacles shall be installed in a readily accessible location.

Please review the above referenced list using your copy of the 2014 NE.

Comments

When an existing receptacle is replaced, grounding-type receptacles are required to be used where a grounding means exists in the receptacle enclosure.

Where an equipment grounding conductor does not exist in the receptacle enclosure, three options are available:

- (1) A non-grounding-type receptacle is permitted to be replaced with another non-grounding-type receptacle;
- (2) A non-grounding-type receptacle(s) is permitted to be replaced with a GFCI-type of receptacle; or
- (3) A non-grounding-type receptacle is permitted to be replaced with a grounding-type receptacle where supplied through a GFCI.

GFCI-protected receptacles are required where replacements are made at receptacle outlets that are required to be so protected elsewhere in the *Code*.

Where a receptacle outlet is supplied by a branch circuit that requires AFCI protection as specified elsewhere in the *Code*, a replacement receptacle at this outlet must be provided with AFCI protection.

Listed tamper-resistant receptacles and weather-resistant receptacles shall be provided where replacements are made at receptacle outlets that are required to be tamper-resistant or weather-resistant elsewhere in this *Code*.

406.5 Receptacle Mounting

Restrictions to prohibit receptacles from being installed in the face-up position are now expanded to all occupancies, not just dwelling units.

Listed receptacle assemblies for countertop applications have been recognized for this application as well.

NEC Language

406.5 Receptacle Mounting

Receptacles shall be mounted in identified boxes or assemblies. ~~designed for the purpose, and such.~~ The boxes or assemblies shall be securely fastened in place unless otherwise permitted elsewhere in this *Code*. Screws used for the purpose of attaching receptacles to a box, shall be of the type provided with a listed receptacle, or machine screws having 32 threads per inch, or part of listed assemblies or systems, in accordance with the manufacturer's instructions.

(E) Receptacles in Countertops and Similar Work Surfaces in

~~**Dwelling Units.**~~ Receptacles, unless listed as receptacle assemblies for countertop applications, shall not be installed in a face-up position in countertops or similar work surfaces. Where receptacles assemblies for countertop applications are required to provide ground-fault circuit-interrupter protection for personnel in accordance with 210.8, such assemblies shall be permitted to be listed as GFCI receptacle assemblies for countertop applications.

Comments

Receptacles were prohibited from being installed in a face-up position in countertops or similar work surfaces, but this prohibition applied to dwelling units only.

The words "in Dwelling Units" were removed from the title of 406.5(E) to make it clear that receptacles cannot be installed in a face-up position in countertops or similar work surfaces of any type occupancy, not just dwelling units.

The NEC also added language to recognize listed receptacle assemblies for countertop applications.

406.5 Receptacle Mounting

(F) Receptacles in Seating Areas and Other Similar Surfaces

The 2014 *NEC* adopted strict language in 406.5(F) that requires receptacles in seating areas or similar surfaces to not be installed in the face-up position unless the receptacle is part of an assembly listed as a furniture power distribution unit (if cord-and-plug-connected) listed to UL Product Standard 962A, or as household or commercial furnishings listed to UL Product Standard 962.

These seat-mounted receptacles can also be listed as a receptacle assembly, or as a GFCI receptacle assembly for countertop applications, or installed in a listed floor box.

NEC Language

406.5 Receptacle Mounting

Receptacles shall be mounted in identified boxes or assemblies. ~~designed for the purpose, and such.~~ The boxes or assemblies shall be securely fastened in place unless otherwise permitted elsewhere in this *Code*. Screws used for the purpose of attaching receptacles to a box, shall be of the type provided with a listed receptacle, or machine screws having 32 threads per inch, or part of listed assemblies or systems, in accordance with the manufacturer's instructions.

(F) Receptacles in Seating Areas and Other Similar Surfaces

In seating areas or similar surfaces, receptacles shall not be installed in a face-up position unless the receptacle is any of the following:

- (1) Part of an assembly listed as a furniture power distribution unit, if cord-and-plug-connected
- (2) Part of an assembly listed either as household furnishings or as commercial furnishings
- (3) Listed either as a receptacle assembly for countertop applications or as a GFCI receptacle assembly for countertop applications.
- (4) Installed in a listed floor box.

Comments

Recently, receptacles are being installed in and on benches and seating areas in public locations such as airports. These are typically installed so that someone can sit on these benches and use the supplied 125-volt receptacle outlet for a laptop computer, or to charge a cell phone or other electronic hand-held device.

In some cases, these receptacles are installed in the face-up position. This represents a hazard-in-waiting as it is possible, in some cases, to sit on the receptacle itself.

Spillage of water, soft drinks, etc., is another issue involving these face-up receptacles.

Where there is a need to install such receptacles in benches or other similar surfaces, it should be done with an assembly listed for the application to prevent damage and potential exposure to energized conductors or circuit parts.

406.9 Receptacles in Damp or Wet Locations

(B) Wet Locations.

(1) 15- and 20-Ampere Receptacles in a Wet Location

The NEC now requires extra duty covers for all 15- and 20-ampere, 125- and 250-volt receptacles installed in a wet location (not just for those supported from grade).

This requirement also includes dwelling unit wet location receptacles as well.

NEC Language

406.9 Receptacles in Damp or Wet Locations

(B) Wet Locations.

(1) 15- and 20-Ampere Receptacles in a Wet Location

15- and 20-ampere, 125- and 250-volt receptacles installed in a wet location shall have an enclosure that is weatherproof whether or not the attachment plug cap is inserted. ~~For other than one- or two-family dwellings, An outlet box hood installed for this purpose shall be listed, and where installed on an enclosure supported from grade as described in 314.23(B) or as described in 314.23(F) shall be identified as "extra-duty."~~ All 15- and 20- ampere, 125- and 250-volt nonlocking-type receptacles shall be listed weather-resistant type.

It may be easier to review the above with the following cleaned up paragraph:

Receptacles of 15 and 20 amperes installed in a wet location shall have an enclosure that is weatherproof whether or not the attachment plug cap is inserted. An outlet box hood installed for this purpose shall be listed and shall be identified as "extra duty." All 15- and 20-ampere, 125- and 250-volt non locking-type receptacles shall be listed weather-resistant type.

Comments

A revision now requires *all* enclosures and covers installed in wet locations for 15- and 20-ampere, 125- and 250-volt receptacles to be listed and of the "extra duty" type, not just boxes supported from grade. This requirement is now also required at dwelling units.

The durability of the nonmetallic in-use cover hoods provided for compliance with these wet location requirements has been found to be less than desirable, especially on construction sites. Breakage and hinge failure to these nonmetallic hood covers has been reported at dwelling units and at non-dwelling units, leaving the receptacles exposed to all weather conditions.

406.12 Tamper-Resistant Receptacles

The NEC expanded the exception for tamper-resistant receptacles at dwelling units to guest rooms and guest suites of hotels and motels and to child care facilities.

NEC Language

406.12 Tamper-Resistant Receptacles in ~~Dwelling Units~~

Tamper resistant receptacles shall be installed as specified in 406.12(A) through (C).

(A) Dwelling Units. In all areas specified in 210.52, all nonlocking-type 125-volt, 15- and 20-ampere receptacles shall be listed tamper-resistant receptacles.

(B) Guest Rooms and Guest Suites of Hotels and Motels.

All nonlocking-type 125-volt, 15- and 20-ampere receptacles located in guest rooms and guest suites of hotels and motels shall be listed tamper-resistant receptacles.

(C) Child Care Facilities. In all child care facilities, all nonlocking-type 125-volt, 15- and 20-ampere receptacles shall be listed tamper resistant receptacles.

Exception to (A), (B), and (C):

Receptacles in the following locations shall not be required to be tamper-resistant:

- (1) Receptacles located more than 1.7 m (5 ½ ft) above the floor.
- (2) Receptacles that are part of a luminaire or appliance.
- (3) A single receptacle or a duplex receptacle for two appliances located within dedicated space for each appliance that, in normal use, is not easily moved from one place to another and that is cord-and plug-connected in accordance with 400.7(A)(6), (A) (7), or (A)(8).
- (4) Nongrounding receptacles used for replacements as permitted in 406.4(D)(2)(a).

406.13 (Deleted)

406.14 (Deleted)

Comments

The exception for tamper-resistant receptacles with four specific locations or areas that applied only to dwelling units in the 2011 *NEC*, now applies to dwelling units, guest rooms and guest suites of hotels and motels, and to child care facilities.

406.15 Dimmer Controlled Receptacles

The NEC now permits dimmer-controlled receptacles for a plug/receptacle combination in listed nonstandard configuration types.

NEC Language

406.15 Dimmer Controlled Receptacles

A receptacle supplying lighting loads shall not be connected to a dimmer unless the plug/receptacle combination is a nonstandard configuration type that is specifically listed and identified for each such unique combination.

Comments

Dimmer switches are generally to be used only to control permanently installed incandescent luminaires unless listed for the control of other loads and installed accordingly.

At 404.14(E), dimmer switches are generally not permitted to control receptacle outlets

The 2014 NEC added a new section at 406.15 to permit specific receptacles to be controlled by a dimmer under specific conditions.

Article 408 Switchboards, Switchgear, and Panelboards

408.1 Scope & 408.3 Support and Arrangement of Busbars and Conductors

The title of Article 408 was changed to "*Switchboards, Switchgear, and Panelboards*," and the scope of Article 408 was revised to reflect this revision.

NEC Language

Article 408 Switchboards, Switchgear, and Panelboards

This article covers switchboards, switchgear, and panelboards. It does not apply to equipment operating at over 600 1000 volts, except as specifically referenced elsewhere in the *Code*.

Comments

The previous definition in Article 100 for *metal-enclosed power switchgear* was modified and retitled simply *switchgear* to make it inclusive of all types of switchgear under the purview of the *NEC*.

The new definition uses the generic term in all locations where the term *switchboard* was previously mentioned, and where the use of the term *switchgear* is appropriate.

According to ANSI C37.20 documents, the term *switchgear* includes *metal-enclosed low-voltage power circuit breaker switchgear*, *metal-clad switchgear*, and *metal-enclosed interrupter switchgear*.

This change also draws the distinction between a switchboard and switchgear by identifying the two pieces of equipment separately in the scope of Article 408.

(E) Phase Bus Arrangement

(1) AC Phase Arrangement

(2) DC Bus Arrangement

The NEC added a new "DC Bus Arrangement" for dc ungrounded buses.

NEC Language

408.3 Support and Arrangement of Busbars and Conductors

(E) Phase Bus Arrangement

(1) AC Phase Arrangement

The AC phase arrangement on 3-phase buses shall be A, B, C from front to back, top to bottom, or left to right, as viewed from the front of the switchboard, switchgear, or panelboard. The B phase shall be that phase having the higher voltage to ground on 3-phase, 4-wire, delta-connected systems. Other busbar arrangements shall be permitted for additions to existing installations and shall be marked.

Exception: Equipment within the same single section or multisection switchboard, switchgear, or panelboard as the meter on 3-phase, 4-wire, delta-connected systems shall be permitted to have the same phase configuration as the metering equipment.

(2) DC Bus Arrangement. DC ungrounded buses shall be permitted to be in any order. Arrangement of dc buses shall be field marked as to polarity, grounding system, and nominal voltage.

Comments

Ungrounded dc buses are permitted to be in any order.

Arrangement of dc buses is to be field marked as to polarity, grounding system, and nominal voltage.

Section 406.3(E)(2) now requires dc buses to be field marked with the applied polarity, grounding system, and nominal voltage.

These are field marking requirements as the manufacturer may not know the grounding system.

Voltage marking is required for both ac and dc systems (see 408.58).

408.4 Field Identification Required

(B) Source of Supply

The NEC added a revision to indicate that switchboards, switchgear, and panelboards can have more than one source of power.

NEC Language

408.4 Field Identification Required

(B) Source of Supply

All switchboards, switchgear, and panelboards supplied by a feeder(s) in other than one- or two-family dwellings shall be marked to indicate the each device or equipment where the power supply originates.

Comments

The 2011 *NEC* added a new provision to indicate that all switchboards and panel boards supplied by a feeder in other than one- or two-family dwellings shall be marked to indicate the device or equipment where the power supply originates.

This language indicated (whether intended or not) that switchboards and panel boards could have only one source of power.

The 2014 *NEC* revised 408.4(B) to add plural language such as "feeder(s)" to clarify that all switchboards, switchgear, and panel boards can have more than one source of power.

408.55 Wire-Bending Space Within an Enclosure Containing a Panelboard

The 2014 *NEC* reorganized Section 408.55 into a list format of types of bending spaces. This also incorporates wire-bending space for rear entry, with a removable cover on the opposite wall of the enclosure.

NEC Language

408.55 Wire-Bending Space Within an Enclosure Containing a Panelboard

(A) Top and Bottom Wire-Bending Space

The enclosure for a panelboard shall have the top and bottom wire-bending space sized in accordance with Table 312.6(B) for the largest conductor entering or leaving the enclosure. Side wire-bending space shall be in accordance with Table 312.6(A) for the largest conductor to be terminated in that space.

Exception No. 1 through Exception No. 4:

(The rest of the text is unchanged. Please use your copy of the NEC for the complete text.)

(B) Side Wire-Bending Space

~~Side wire-bending space shall be in accordance with Table 312.6(A) for the largest conductor to be terminated in that space.~~

(C) Back Wire-Bending Space

Where a raceway or cable entry is in the wall of the enclosure opposite a removable cover, the distance from that wall to the cover shall be permitted to comply with the distance required for one wire per terminal in Table 312.6(A).

The distance between the center of the rear entry and the nearest termination for the entering conductors shall not be less than the distance given in Table 312.6(B).

Due to the size of the Table, you will need to review it using your copy of the NEC

Comments

This section was reorganized into a list format for clarity.

Besides the existing provisions for top, bottom, and side wire-bending spaces, provisions were added for "*Back Wire-Bending Space.*"

This new subsection (C) now addresses wire bending space for rear entry with a removable cover on the opposite wall of the enclosure with the distance from that wall to the cover complying with the distance required for one wire per terminal in Table 312.6(A).

The distance between the center of the rear entry and the nearest termination for the entering conductors cannot be less than the distance given in Table 312.6(B).

ARTICLE 409 Industrial Control Panels

409.1 Scope & 409.20 Conductor – Minimum Size and Ampacity. (Industrial Control Panels)

This article covers industrial control panels intended for general use and operating at 1000 volts or less.

Informational Note: ANSI/UL 508, *Standard for Industrial Control Panels*, is a safety standard for industrial control panels.

All heating loads — not just resistance heating loads — are now required to be calculated when sizing the conductors which supply industrial control panels.

NEC Language

409.20 Conductor – Minimum Size and Ampacity. (Industrial Control Panels)

The size of the industrial control panel supply conductor shall have an ampacity not less than 125 percent of the full-load current rating of all ~~resistance~~ heating loads plus 125 percent of the full-load current rating of the highest rated motor plus the sum of the full-load current ratings of all other connected motors and apparatus based on their duty cycle that may be in operation at the same time.

Comments

Industrial control panel supply conductors were required to have an ampacity not less than 125 percent of the full-load current rating of all resistance heating loads plus 125 percent of the full-load current rating of the highest rated motor plus the sum of the full-load current ratings of all other connected motors and apparatus. This was to be based on the duty cycle of the motors and apparatus that may be in operation at the same time.

The 2014 revision to 409.20 removes the word, "*resistance*" to indicate that *all* heating loads were to be included in the ampacity equation for industrial control panels, not just resistance heating loads.

ARTICLE 410 Luminaires, Lampholders, and Lamps

410.1 Scope & 410.6 Listing Required

This article covers luminaires, portable luminaires, lampholders, pendants, incandescent filament lamps, arc lamps, electric-discharge lamps, decorative lighting products, lighting accessories for temporary seasonal and holiday use, portable flexible lighting products, and the wiring and equipment forming part of such products and lighting installations.

Listing requirements for luminaires and lampholders have been expanded to retrofit kits.

NEC Language

410.6 Listing Required

All luminaires, lampholders, and retrofit kits shall be listed.

Comments

The NEC requires all luminaires and lampholders to be listed.

Listing requirements in Article 410 were expanded to include retrofit kits as well as luminaires and lampholders.

Extensive upgrades are underway in the lighting and sign industries to achieve greater energy efficiency in luminaires and signs by replacing in-place illumination systems with light emitting diodes (LED) technology. In the case of Article 410, this will incorporate field modifications of existing luminaires.

410.10 Luminaires in Specific Locations

(F) Luminaires Installed in or Under Roof Decking

The NEC no longer permits luminaires to be installed within 38 mm (1½ in.) of the lowest metal deck surface.

NEC Language

410.10 Luminaires in Specific Locations

(F) Luminaires Installed in or Under Roof Decking

Luminaires installed in exposed or concealed locations under metal-corrugated sheet roof decking, shall be installed and supported so there is not less than 38 mm (1½ in.) measured from the lowest surface of the roof decking to the top of the luminaire.

Comments

The 2014 NEC added new provisions at 410.10(F) that will bring luminaires in line with cables, raceways, and boxes as for as their location in proximity to metal-corrugated sheet roof decking.

The process of laying down roofing materials and the re-roofing process can cause damage to wiring methods, boxes, and luminaires installed in close proximity to metal roof decking.

The fastening devices used to hold down roofing materials are typically driven through the metal decking as a normal part of their installation. These roofing fastening devices are typically 32 mm (1¼ in.) in length.

Where cables, raceways, and other electrical devices are installed on the underside of the decking and the required spacing is not maintained between the decking and the electrical components, these components are vulnerable to damage by penetrating roof material fasteners.

410.130 General. (Electric Discharge Lighting Systems of 1000 Volts or Less)

(G) Disconnecting Means

(1) General

Exception No. 4

The 2014 NEC deleted **Exception 4**. This exception stated that disconnecting means were not required in industrial establishments that had limited public access and qualified personnel who serviced by written procedures.

NEC Language

410.130 General. (Electric Discharge Lighting Systems of 1000 Volts or Less)

(G) Disconnecting Means

(1) General

In indoor locations other than dwellings and associated accessory structures, fluorescent luminaires that utilize double-ended lamps and contain ballast(s) that can be serviced in place shall have a disconnecting means either internal or external to each luminaire. For existing installed luminaires without disconnecting means, at the time a ballast is replaced, a disconnecting means shall be installed. The line side terminals of the disconnecting means shall be guarded.

Exception No. 1: A disconnecting means shall not be required for luminaires installed in hazardous (classified) location(s).

Exception No. 2: A disconnecting means shall not be required for emergency illumination required in 700.16.

Exception No. 3: For cord-and plug-connected luminaires, an accessible separable connector or an accessible plug and receptacle shall be permitted to serve as the disconnecting means.

~~**Exception No. 4:** A disconnecting means shall not be required in industrial establishments with restricted public access where conditions of maintenance and supervision ensure that only qualified persons service the installation by written procedures.~~

Exception No. 5 4: Where more than one luminaire is installed and supplied by other than a multiwire branch circuit, a disconnecting means shall not be required for every luminaire when the design of the installation includes disconnecting means, such that the illuminated space cannot be left in total darkness.

Comments

The parent text at 410.130(G)(1) requires fluorescent luminaires that utilize double-ended lamps and contain ballast(s) to have a local disconnecting means either internal or external to each luminaire. This would also include existing installed luminaires without disconnecting means, at the time ballast is replaced. This provision does not pertain to dwelling unit luminaires.

~~**Exception No. 4** to 410.130(G)(1) that was deleted dealt with industrial establishments with restricted public access where conditions of maintenance and supervision ensure that only qualified persons service the installation by written procedures.~~

These industrial areas will no longer be exempted from a local disconnecting means at indoor fluorescent luminaires (employing a ballast).

ARTICLE 422 Appliances

422.1 Scope & 422.5 Ground-Fault Circuit-Interrupter (GFCI) Protection

This article covers electrical appliances used in any occupancy.

The NEC now requires GFCI devices providing protection to appliances in Article 422 to be installed in readily accessible locations.

NEC Language

422.5 Ground-Fault Circuit-Interrupter (GFCI) Protection

The device providing GFCI protection required in this article shall be readily accessible.

Comments

Manufacturers of GFCI protective devices routinely require that their GFCI device be tested on a monthly basis to ensure it is providing the life-safety protection intended. These provisions can typically be found in the manufacturer's specifications that accompany the GFCI product.

When a GFCI device is installed in locations that are not readily accessible, such as behind a refrigerator or behind a vending machine, the ability for someone, such as the homeowner or maintenance personnel at a shopping mall, to test the GFCI device is greatly impaired.

Installation of these devices in a readily accessible location will greatly aid in this monthly testing process and, at the very least, not hinder this testing process.

422.11 Overcurrent Protection

Changed From NEC 2011

(F) Electric Heating Appliances Employing Resistance-Type Heating Elements Rated More Than 48 Amperes.

(3) Water Heaters and Steam Boilers

Resistance-type immersion electric heating elements for low-pressure water heater tanks or open-outlet water heater vessels are now permitted to be subdivided into 120-amperes circuits and protected at not more than 150 amperes.

NEC Language

422.11 Overcurrent Protection

The NEC now requires that appliances be protected against overcurrent in accordance with 422.11(A) through (G) and 422.10.

(F) Electric Heating Appliances Employing Resistance-Type Heating Elements Rated More Than 48 Amperes.

(1) Electric Heating Appliances.

(The text is unchanged. Please use your copy of the NEC for the complete text.)

(2) Commercial Kitchen and Cooking Appliances

(Text unchanged, please see your copy of the NEC for the complete text.)

(3) Water Heaters and Steam Boilers

~~Water heaters and steam boilers employing Resistance-type immersion electric heating elements contained in an ASME-rated and stamped vessel or listed instantaneous water heaters shall be permitted to be subdivided into circuits not exceeding 120 amperes and protected at not more than 150 amperes as follows:~~

- (1) Where contained in ASME rated and stamped vessels
- (2) Where included in listed instantaneous water heaters
- (3) Where installed in low-pressure water heater tanks or open outlet water heater vessels

Informational Note: Low-pressure and open-outlet heaters are atmospheric-pressure water heaters as defined in IEC 60335-2-21 Household and similar electrical appliances – Safety – Particular requirements for storage water heaters.

Comments

Electric heating appliances employing resistance-type heating elements rated more than 48 amperes, generally are required to have their heating elements subdivided.

Each subdivided load cannot exceed 48 amperes and must be protected at not more than 60 amperes.

Water heaters and steam boilers employing resistance-type immersion electric heating elements contained in an *American Society of Mechanical Engineers (ASME)*-rated and stamped vessel or listed instantaneous water heaters are permitted to be subdivided into circuits not exceeding 120 amperes and protected at not more than 150 amperes.

The 2014 *NEC*, 422.11(F)(3) was revised into a list format and low-pressure water heater tanks or open-outlet water heater vessels were added to this provision. This revision will now allow low-pressure water heater tanks or open-outlet water heater vessels to be subdivided into 120-ampere circuits instead of the 48 amperes restriction in the parent text of 422.11(F).

422.23 Tire Inflation and Automotive Vacuum Machines

The 2014 *NEC* now requires GFCI protection for all tire inflation and automotive vacuum machines provided for public use.

NEC Language

422.23 Tire Inflation and Automotive Vacuum Machines

Tire inflation machines and automotive vacuum machines provided for public use shall be protected by a ground-fault circuit-interrupter.

Comments

The 2014 NEC added a new section 422.33 to require ground-fault circuit-interrupter (GFCI) protection for all tire inflation machines and automotive vacuum machines provided for public use.

Generally, tire inflation and automotive vacuum machines are located in commercial establishments, such as convenience stores and car wash areas, where they are heavily used by the general public. This type of public-use equipment is typically exposed to the elements and is often misused to the point of abuse.

422.49 High-Pressure Spray Washers

The NEC expanded GFCI protection in the cord or the plug of high-pressure spray washing machines to three-phase equipment rated 208Y/120 volts and 60 amperes or less.

NEC Language

422.49 High-Pressure Spray Washers

~~All single-phase Cord and plug-connected high-pressure spray washing machines rated at 250 volts or less as specified in (1) or (2) shall be provided with factory-installed ground-fault circuit-interrupter protection for personnel. The ground-fault circuit interrupter shall be that is an integral part of the attachment plug or shall be that is located in the supply cord within 300 mm (12 in.) of the attachment plug.~~

To make it easier to read, here is the cleaned-up version:

422.49 High-Pressure Spray Washers

Cord-and plug connected high-pressure spray washing machines as specified in 422.49(1) or (2) shall be provided with factory installed ground-fault circuit-interrupter protection for personnel that is an integral part of the attachment plug or that is located in the supply cord within 300 mm (12 in.) of the attachment plug.

(1) All single-phase equipment rated 250 volts or less

(2) All three-phase equipment rated 208Y/120 volts and 60 amperes or less.

Comments

The GFCI for this purpose is required to be an integral part of the attachment plug or it must be located in the supply cord within 300 mm (12 in.) of the attachment plug.

The 2014 NEC expanded the requirement for cord- and plug-connected high-pressure spray washing machines with factory-installed GFCI protection to three-phase equipment rated 208Y/120 volts and 60 amperes or less, as well as to single-phase equipment rated 250 volts or less.

422.51 Cord-and-Plug-Connected Vending Machines

The 2014 NEC expanded GFCI protection to hard-wired vending machines as well as to cord- and plug-connected vending machines.

NEC Language

422.51 Cord-and-Plug-Connected Vending Machines

(A) Cord- and Plug-Connected.

Cord- and plug connected vending machines manufactured or remanufactured on or after January 1, 2005, shall include a ground fault circuit interrupter identified for portable use as an integral part of the attachment plug or be located within 300 mm (12 in.) of the attachment plug. Older vending machines manufactured or remanufactured prior to January 1, 2005, shall be connected to a GFCI-protected outlet.

(B) Other Than Cord-and Plug-Connected

Vending machines not utilizing a cord- and plug connection shall be connected to a ground fault circuit interrupter protected circuit.

Informational Note: For further information, see ANSI/UL 541-2005 2010, Standard for Refrigerated Vending Machines, or ANSI/UL 751-2005 2010, Standard for Vending Machines.

Comments

Cord- and plug-connected vending machines must be provided with a ground-fault circuit interrupter (GFCI) as an integral part of the attachment plug or to be located within 300 mm (12 in.) of the attachment plug.

This GFCI requirement applies to vending machines manufactured or remanufactured on or after January 1, 2005. Older vending machines manufactured or remanufactured prior to January 1, 2005, are required to be connected to a GFCI-protected outlet.

The requirement for GFCI protection for vending machines was expanded to other than cord- and plug-connected vending machines, such as direct hard-wired vending machines. For cord- and plug-connected vending machines, the GFCI protection must be provided by a GFCI device that is "*identified for portable use.*"

A GFCI receptacle outlet can no longer be installed behind a vending machine.

Under previous editions of the *Code*, if the GFCI receptacle outlet for a vending machine was installed outdoors, it had to be installed in a readily accessible location in accordance of 210.8(B)(4); but this new readily accessible provision at 422.5 would require *all* GFCI devices to be installed in a readily accessible location (indoors or outdoors).

ARTICLE 424 Fixed Electric Space-Heating Equipment

424.1 Scope & 424.19 Disconnecting Means. (Fixed Electric Space-Heating Equipment)

This article covers fixed electric equipment used for space heating. For the purpose of this article, heating equipment shall include heating cable, unit heaters, boilers, central systems, or other approved fixed electric space-heating equipment. This article shall not apply to process heating and room air conditioning.

Fixed electric space-heating equipment can now be supplied by more than one source that can include more than one feeder or branch circuit.

NEC Language

424.19 Disconnecting Means. (Fixed Electric Space-Heating Equipment)

Means shall be provided to simultaneously disconnect the heater, motor controller(s), and supplementary overcurrent protective device(s) of all fixed electric space-heating equipment from all ungrounded conductors. Where heating equipment is supplied by more than one source, feeder, or branch circuit, the disconnecting means shall be grouped and marked. The disconnecting means specified in 424.19(A) and (B) shall have an ampere rating not less than 125 percent of the total load of the motors and the heaters and shall be lockable in accordance with 110.25. ~~The provision for locking or adding a lock to the disconnecting means shall be installed on or at the switch or circuit breaker used as the disconnecting means and shall remain in place with or without the lock installed.~~

Comments

The NEC requires simultaneous disconnecting means for the heater, motor controller(s), and supplementary overcurrent protective device(s) of all fixed electric space-heating equipment.

The disconnecting means generally must have an ampere rating not less than 125 percent of the total load of the motors and the heaters.

A provision for locking or adding a lock to the disconnecting means has to be installed on or at the disconnecting means and shall remain in place with or without the lock installed.

Where heating equipment is supplied by more than one source, the disconnecting means is required to be grouped and marked.

424.66 Installations

(A) (Duct Heaters)

(B) Limited Access

The NEC now requires limited forms of working space about duct heaters for fixed electric space-heating equipment.

NEC Language

424.66 Installations

(A) (Duct Heaters)

Duct heaters shall be installed in accordance with the manufacturer's instructions in such a manner that operation does not create a hazard to persons or property. Furthermore, duct heaters shall be located with respect to building construction and other equipment so as to permit access to the heater. Sufficient clearance shall be maintained to permit replacement of controls and heating elements and for adjusting and cleaning of controls and other parts requiring such attention. See 110.26.

Working space about electrical enclosures for resistance heating element type duct heaters which are mounted on duct systems and contain equipment that requires examination, adjustment, servicing, or maintenance while energized shall comply with Section 424.66(B).

(B) Limited Access

Where the enclosure is located in a space above a ceiling, all of the following shall apply:

- (1) The enclosure shall be accessible through a lay in type ceiling or access panel(s).
- (2) The width of the working space shall be the width of the enclosure or a minimum of 762 mm (30 in.), whichever is greater.
- (3) All doors or hinged panels shall open to at least 90 degrees.
- (4) The space in front of the enclosure shall comply with Table 110.26(A)(1) depth requirements.

Horizontal ceiling T-bar is permitted in this space.

Informational Note: For additional installation information, see NFPA 90A-2009, Standard for the Installation of Air-Conditioning and Ventilating Systems, and NFPA 90B- 2009, Standard for the Installation of Warm Air Heating and Air-Conditioning Systems.

Comments

424.66 required duct heaters to be located with respect to building construction and other equipment so as to permit "access to the heater."

This section indicates that sufficient clearance must be maintained to permit replacement of controls and heating elements, and for adjusting and cleaning of controls and other parts requiring such attention.

ARTICLE 430 Motors, Motor Circuits, and Controllers

430.1 Scope & 430.22 Single Motor

This article covers motors, motor branch circuit and feeder conductors and their protection, motor overload protection, motor control circuits, motor controllers, and motor control centers.

Informational Note No. 1: Installation requirements for motor control centers are covered in 110.26(E). Air conditioning and refrigerating equipment are covered in Article 440.

Informational Note No. 2: Figure 430.1 is for information only.

(G) Conductors for Small Motors

The current referred to within 430.22(G) is the current of the motor and not of the conductors.

The NEC removed the term *ampacity* as motors do not have *ampacities*; they have *current values*.

NEC Language

430.22 Single Motor

Conductors that supply a single motor used in a continuous duty application shall have an ampacity of not less than 125 percent of the motor full-load current rating, as determined by 430.6(A) (1), or not less than specified in 430.22(A) through (G).

(G) Conductors for Small Motors

Conductors for small motors shall not be smaller than 14 AWG unless otherwise permitted in 430.22(G)(1) or (G)(2).

(1) 18 AWG Copper. Where installed in a cabinet or enclosure, 18 AWG individual copper conductors, copper conductors that are part of a jacketed multiconductor cable assembly, or copper conductors in a flexible cord shall be permitted, under either of the following sets of conditions:

(1) The circuit supplies a motor circuits with a full-load current rating, as determined by 430.6(A) (1), ampacity greater than 3.5 amperes or less than or equal to 5 amperes and if all the following conditions are met:

a. The circuit is protected in accordance with 430.52.

b. The circuit is provided with maximum Class 10 or Class 10A overload protection in accordance with 430.32.

c. Overcurrent protection is provided in accordance with 240.4(D)(1)(2).

(2) The circuit supplies a motor circuits with a full-load current rating, as determined by 430.6(A)(1), ampacity of 3.5 amperes or less if and all the following conditions are met:

- a. The circuit is protected in accordance with 430.52.
- b. The circuit is provided with maximum Class 20 overload protection in accordance with 430.32.
- c. Overcurrent protection is provided in accordance with 240.4(D)(1)(2).

(2) 16 AWG Copper. *(Same changes for 16 AWG copper. See NEC for complete text.)*

Comments

The 2014 NEC revised Section 430.22(G) to clarify that the current referred to within 430.22(G) is *the current of the motor and not of the conductors*.

A further clarification indicates that the 125 percent multiplier for continuous duty required by the parent text at 430.22 is not required to be calculated in determining the conductor sizing for these small motors, due to the fact the motor full-load current rating cannot exceed the values given in these subsections for 16 and 18 AWG conductors.

The 125 percent multiplier is already included due to the limitations imposed on the maximum current rating of the motor allowed for the 16 and 18 AWG conductors.

The term *ampacity* was removed throughout this subsection as it is only permitted to be used in conjunction with the ability of a conductor to carry current.

430.52 Rating or Setting for Individual Motor Circuit

(C) Rating or Setting.

(5) Power Electronic Devices

Semiconductor fuses intended to protect bypass contactors, isolation contactors, and conductors in a solid-state motor control system are now permitted in lieu of devices listed in Table 430.52.

NEC Language

430.52 Rating or Setting for Individual Motor Circuit

(C) Rating or Setting.

(5) Power Electronic Devices

Suitable Semiconductor fuses intended for the protection of electronic devices shall be permitted in lieu of devices listed in Table 430.52 for power electronic devices, associated electromechanical devices (such as bypass contactors and isolation contactors) and conductors in a solid-state motor controller system, provided that the marking for replacement fuses is provided adjacent to the fuses.

Comments

The NEC replaced "Suitable fuses" with "Semiconductor fuses" and clarified their purpose as "intended for the protection of electronic devices." Examples of "power electronic devices," such as bypass and isolation contactors, were added along with their conductors.

Semiconductor fuses replace "suitable" fuses as the word "suitable" is vague and unenforceable. The revised wording clarifies the type of fuses that are permitted in this application.

Semiconductor fuses are evaluated to UL Product Standard 248-13. This revision also clarifies that semiconductor fuses are permitted in systems which contain non-electronic power devices, such as contactors.

Semiconductor fuses are typically used to protect against overcurrent conditions in semiconductor devices.

Because of their fast action, semiconductor fuses help to limit short-circuit current significantly.

Semiconductor fuses are intended for short-circuit protection only, and are not designed to be used as traditional current-limiting fuses.

Special purpose semiconductor fuses provided for branch-circuit short-circuit protection of solid-state motor controller systems must be evaluated as part of a listed combination motor controller in order to ensure their proper use and coordination.

430.53 Several Motors or Loads on One Branch Circuit

(D) Single Motor Taps

The NEC now clarified that the 3 m (10 ft) and the 7.5 m (25 ft) tap conductors measurements for a motor are intended to begin from the point of the tap.

NEC Language

430.53 Several Motors or Loads on One Branch Circuit

Two or more motors or one or more motors and other loads shall be permitted to be connected to the same branch circuit under conditions specified in 430.53(D) and in 430.53(A), (B), or (C). The branch-circuit protective device shall be fuses or inverse time circuit breakers.

(D) Single Motor Taps

For group installations described above, the conductors of any tap supplying a single motor shall not be required to have an individual branch-circuit short-circuit and ground-fault protective device, provided they comply with one of the following:

(1) No conductor to the motor shall have an ampacity less than that of the branch-circuit conductors.

(2) No conductor to the motor shall have an ampacity less than one-third that of the branch-circuit conductors, with a minimum in accordance with 430.22. The conductors from the point of the tap to the motor overload device shall be ~~being~~ not more than 7.5 m (25 ft) long and be ~~being~~ protected from physical damage by being enclosed in an approved raceway or by use of other approved means.

(3) Conductors from the branch-circuit short-circuit and ground-fault protective device to a listed manual motor controller additionally marked "Suitable for Tap Conductor Protection in Group Installations," or to a branch circuit protective device, shall be permitted to have an ampacity not less than one-tenth the rating or setting of the branch-circuit short-circuit and ground-fault protective device. The conductors from the controller to the motor shall have an ampacity in accordance with 430.22. The conductors from the point of the tap ~~branch-circuit short-circuit and ground-fault protective device~~ to the controller(s) shall (1) be suitably protected from physical damage and enclosed either by an enclosed controller or by a raceway and be not more than 3 m (10 ft) long or (2) have an ampacity not less than that of the branch-circuit conductors.

Comments

Installation of multiple motors on a single branch circuit that is protected by a single branch-circuit short-circuit and ground-fault protective device is a common industry practice.

This is typically referred to as a "*group motor installation*." In its simplest form, group motor installation means that multiple motors and their conductors, or one motor and other loads and their conductors, are protected by a single branch-circuit short-circuit and ground-fault protective device. However, numerous requirements must be met for a group motor installation to be compliant with the NEC.

Establishing the conductor size of the group motor branch circuit taps can be found in 430.53. Section 430.53(D) prescribes that any tap supplying a single motor is not required to be protected by a single branch-circuit short-circuit and ground-fault protective device as long as it meets one of three requirements specified.

Clarification was needed at these tap conditions to remove any doubt as to where the measurement of these taps was to begin and to end.

- For not more than 7.5 m (25 ft) long single motor taps, the tap is to be measured from the "point of the tap" to the motor overload device.
- For not more than 3 m (10 ft) long single motor taps, the measurement runs from the "point of the tap" to the controller(s).

430.233 Guards for Attendants

The minimum voltage levels for live parts of motors or controllers requiring guarding against accidental contact by insulating mats or platforms were lowered from 150 volts to ground to 50 volts to ground.

NEC Language

430.233 Guards for Attendants

Where live parts of motors or controllers operating at over 50 volts to ground are guarded against accidental contact only by location as specified in 430.232, and where adjustment or other attendance may be necessary during the operation of the apparatus, suitable insulating mats or platforms shall be provided so that the attendant cannot readily touch live parts unless standing on the mats or platforms.

Informational Note: For working space, see 110.26 and 110.34.

Comments

The same provisions for guarding against accidental contact from exposed live parts of motors and controllers and insulating mats or platforms exist as in the 2011 NEC, but the minimum voltage levels for inclusion of the insulating mats or platforms were lowered from 150 volts to ground to 50 volts to ground.

According to *NFPA 70E Standard for Electrical Safety in the Workplace*, the *NEC*, and the *U.S. Occupational Safety and Health Administration (OSHA)*, any voltage above 50 volts is considered an electrical shock hazard.

Section 430.233 was one place in previous editions of the Code where the voltage to ground was allowed to be greater than 50 volts.

Some users perceived that this 150-volt level at 430.233 sent a mixed message about the safe voltage level and the types of protection that need to be provided for the qualified person working around exposed live parts of motors and controllers.

This lowering of the minimum voltage level will ensure the same level of safety for qualified persons as afforded to unqualified persons.

ARTICLE 440 Air-Conditioning and Refrigerating Equipment

440.1 Scope & 440.9 Grounding and Bonding

The provisions of this article apply to electric motor-driven air-conditioning and refrigerating equipment and to the branch circuits and controllers for such equipment.

2014 NEC Changes - Chapter 4: Equipment for General Use

It provides for the special considerations necessary for circuits supplying hermetic refrigerant motor compressors and for any air-conditioning or refrigerating equipment that is supplied from a branch circuit that supplies a hermetic refrigerant motor-compressor.

The 2014 NEC now requires a wire type equipment grounding conductor for outdoor HVAC equipment in the outdoor portion of the wiring method of LFMC or EMT.

NEC Language

440.9 Grounding and Bonding

Where air-conditioning and refrigeration equipment are installed outdoors with wiring methods consisting of liquidtight flexible metal conduit or electrical metallic tubing, a wire type equipment grounding conductor, as specified in 250.118(1), shall be provided in the outdoor portion of the raceway.

Comments

The intent of this new provision is to require an equipment grounding conductor of the wire type for non-threaded metallic conduit that supplies power to air-conditioning and refrigeration equipment where located outside.

The equipment grounding conductor serves to bond all metal parts together and to connect these same metal parts to the service or separately derived system's grounding electrode system.

The equipment grounding conductor provides both a grounding and a bonding function.

The primary purpose of this all-important conductor is to facilitate the operation of overcurrent devices underground-fault current conditions. It is critical to maintain this grounding and bonding continuity.

ARTICLE 445 Generators

445.1 Scope & 445.11 Marking

This article contains installation and other requirements for generators.

Marking is now required for generators to indicate when the neutral of a generator is bonded to the generator frame.

NEC Language

445.11 Marking

Each generator shall be provided with a nameplate giving the manufacturer's name, the rated frequency, ~~power-factor~~ the number of phases-if of ac ~~alternating current~~, ~~the subtransient and transient impedances~~, the rating in kilowatts or kilovolt-amperes, the normal volts and amperes

corresponding to the rating, the rated revolutions per minute, ~~insulation system class~~ and the rated ambient temperature or rated temperature rise, ~~and time rating~~.

Nameplates for all stationary generators and portable generators rated more than 15 kW shall also give the power factor, the subtransient and transient impedances, the insulation system class, and the time rating.

Marking shall be provided by the manufacturer to indicate whether or not the generator neutral is bonded to the generator frame.

Where the bonding of a generator is modified in the field, additional marking shall be required to indicate whether the generator neutral is bonded to the generator frame.

Comments

The 2014 NEC maintains previous marking provisions, but the power factor, the subtransient and transient impedances, the insulation system class, and the time rating markings are now required only for stationary and portable generators rated more than 15 kW.

The NEC now also requires a new manufacturer's marking provision indicating whether or not the generator neutral is bonded to the generator frame. This further requires additional marking to indicate whether the generator neutral is bonded to the generator frame, whenever the bonding of a generator is modified in the field.

Since the generator neutral bonding point could be modified in the field, the 2014 NEC added a second sentence to require additional marking when that occurs.

445.18 Disconnecting Means Required for Generators

Informational Note

The NEC added a cord and plug connection as an acceptable disconnecting means for portable generators.

NEC Language

445.18 Disconnecting Means Required for Generators

Generators shall be equipped with disconnect(s), lockable in the open position, by means of which the generator and all protective devices and control apparatus are able to be disconnected entirely from the circuits supplied by the generator except where both of the following conditions apply:

- (1) Portable generators that are cord and plug connected or
- (2) Where both of the following conditions apply:

- (a) The driving means for the generator can be readily shut down, rendered incapable of restarting and is lockable in the OFF position in accordance with 110.25.
- (b) The generator is not arranged to operate in parallel with another generator or other source of voltage.

Informational Note: See UL 2200 Standard for Safety of Stationary Engine Generator Assemblies.

Comments

Generators disconnect(s) must be lockable in the open position. This must be able to disconnect the generator and all protective devices, and to control apparatus entirely from the circuits supplied by the generator.

Previous conditions overrode this generator disconnecting means rule:

- If the driving means for the generator can be readily shut down; and
- The generator is not arranged to operate in parallel with another generator or other source of voltage.

The 2014 NEC added more conditions to the circumstances that permit the disconnecting means requirements for generators to be omitted:

- For portable generators that supply power from a self-contained receptacle outlet which would accept a cord and plug connection, the cord and plug can serve as the disconnecting means.
- For generators where the driving means can be readily shut down, they must also be rendered incapable of restarting and be lockable in the off or "open" position in accordance with the new locking provisions of 110.25 in order to suspend the requirement for a disconnecting means.

445.20 Ground-Fault Circuit-Interrupter Protection for Receptacles on 15-kW or Smaller, Portable Generators

The NEC added new GFCI requirements for portable generators and associated 125-volt, single-phase, 15- or 20-amperes receptacles.

NEC Language

445.20 Ground-Fault Circuit-Interrupter Protection for Receptacles on 15-kW or Smaller, Portable Generators

All 125-volt, single-phase, 15- and 20 ampere receptacle outlets, that are a part of a 15 kW or smaller, portable generator, either shall have ground-fault circuit interrupter protection for personnel integral to the generator or receptacle, or shall not be available for use when the 125/250 volt locking-type receptacle is in use.

If the generator does not have a 125/250 volt locking-type receptacle, this requirement shall not apply.

Comments

Small portable generators sized at 15 kW or smaller are used extensively for temporary power at construction sites, but are also used for camping, temporary connection of electrical circuits in homes, power for small commercial buildings during outages, and for emergency situations due to natural disasters such as hurricanes.

Requiring all 125-volt, single-phase, 15- and 20-ampere receptacles on 15 kW or smaller generators to be integrally GFCI-protected helps eliminate the possibilities of shock hazards from damaged circuits, damaged equipment, or the use of equipment in wet locations.

By limiting GFCI protection to only 15- and 20-ampere, single-phase, 120-volt circuits, these small generators can still be used for supplying standby power for non-GFCI-protected 30-ampere, and larger 120/240 single-phase, 3-wire with ground as well as 3-phase circuits of all sizes for houses and small commercial buildings.

Typically, the duplex receptacles on the portable generator are not used when powering the entire building or large portions of the building because the occupants want as much power to the building as possible through the locking 125/250-volt receptacle, which is typically used to power the building.

ARTICLE 450 Transformers and Transformer Vaults (Including Secondary Ties)

450.1 Scope & 450.10 Grounding

This article covers the installation of all transformers.

The NEC no longer permits a grounding and bonding terminal bar in transformer enclosures to be installed on or over the vent screen portion of the enclosure.

NEC Language

450.10 Grounding

(A) Dry-Type Transformer Enclosures

Where separate equipment grounding conductors and supply-side bonding jumpers are installed, a terminal bar for all grounding and bonding conductor connections shall be secured inside the transformer enclosure.

The terminal bar shall be bonded to the enclosure in accordance with 250.12 and shall not be installed on or over any vented portion of the enclosure.

Exception: Where a dry-type transformer is equipped with wire-type connections (leads), the grounding and bonding connections shall be permitted to be connected together using any of the methods in 250.8 and shall be bonded to the enclosure if of metal.

(B) Other Metal Parts. Where grounded, exposed non-current-carrying metal parts of transformer installations, including fences, guards, and so forth, shall be grounded and bonded under the conditions and in the manner specified for electrical equipment and other exposed metal parts in Parts V, VI, and VII of Article 250.

Comments

The 2014 NEC added new provisions for terminating grounding and bonding conductors inside a transformer enclosure. These conductors could include equipment grounding conductors, supply-side bonding jumpers, etc.

A grounding and bonding terminal bar for landing these grounding and bonding conductors must be bonded to the transformer enclosure, but cannot be mounted on or over any vented opening or vented screens provided by the manufacturer of the transformer enclosure.

A new exception to this new grounding and bonding main rule addresses transformers equipped with wire-type connections (pig-tail leads). Under this wire-type connection condition, the grounding and bonding connections are permitted to be connected together using any of the methods in 250.8, *Connection of Grounding and Bonding Equipment*, and shall be bonded to the enclosure (if the enclosure is metal).

The existing rule for grounding and bonding of other metal parts associated with the installation of a transformer has become 450.10(B).

450.11 Marking

The NEC revised marking requirements for transformers into a list format.

Transformers can be supplied at the secondary voltage (reversed wired) only in accordance with manufacturer's instructions.

NEC Language

450.11 Marking

(A) General. Each transformer shall be provided with a nameplate giving the following information:

- (1) Name of manufacturer
- (2) Rated kilovolt-amperes
- (3) Frequency
- (4) Primary and secondary voltage
- (5) Impedance of transformers 25 kVA and larger

2014 NEC Changes - Chapter 4: Equipment for General Use

(6) Required clearances for transformers with ventilating openings

(7) Amount and kind of insulating liquid where used

(8) For dry-type transformers, temperature class for the insulation system

(B) Source Marking. A transformer shall be permitted to be supplied at the marked secondary voltage, provided that the installation is in accordance with the manufacturer's instructions.

Comments

The required nameplate information for transformers was formatted into a more user-friendly list format.

Article 480 Storage Batteries

480.1 to 480.10

The provisions of this article shall apply to all stationary installations of storage batteries.

480.1 Scope

The 2014 NEC made several changes in Article 480 that necessitate restructuring the article.

A new 480.3 was added for "Battery and Cell Terminations."

A new 480.6 was added for "DC Disconnect Methods."

Section 480.9 was revised from "Working Space" to "Battery Locations."

2014 NEC Language

480.2 Definitions

480.3 Battery and Cell Terminations

480.4 Wiring and Equipment Supplied from Batteries

480.5 Overcurrent Protection for Prime Movers

480.6 DC Disconnect Methods

480.7 Insulation of Batteries Not Over 250 Volts

480.7 Insulation of Batteries of over 250 Volts

480.8 Racks and Trays

480.9 Battery Locations

480.10 Vents

Comments

The 2014 NEC restructures *Article 480, Storage Batteries*.

Please see your copy of the 2014 NEC for the complete text and article structure.

Some of the more noteworthy changes are at the new *480.3, Battery and Cell Terminations*, which provides needed guidance for dissimilar metals at battery connections, for intercell and intertier conductors and connectors, and for electrical connections to the battery terminals.

Another change was made at *480.8(C), Accessibility*, which adds requirements for terminals and transparent battery containers to be readily accessible.

Another change was made *480.9(D), Top Terminal Batteries*, under battery locations; this subsection addresses working space requirements for top-terminal batteries and requires them to be in accordance with the manufacturer's instructions.

ARTICLE 490 Equipment Over 1000 Volts, Nominal

490.1 Scope & 490.48 Substations

This article covers the general requirements for equipment operating at more than 1000 volts, nominal.

The NEC removed requirements for substations from 225.70 in their entirety and relocated them at the new 490.48(B).

New provisions for substations were added at 490.48(A) and (C).

NEC Language

490.48 Substations

(A) Documentation

- (1) General
- (2) Protective Grounding
- (3) Guarding Live Parts
- (4) Transformers and Regulators
- (5) Conductors
- (6) Circuit Breakers, Switches, and Fuses

(7) Switchgear Assemblies

(8) Metal-Enclosed Bus

(9) Surge Arresters

(B) Warning Signs

(1) General

(2) Isolating Equipment

(3) Fuse Locations

(4) Backfeed

(5) Metal-Enclosed and Metal-

Clad Switchgear

(C) Diagram

(Please see your copy of the 2014 NEC for reviewing the complete text)

Comments

The 2014 NEC removed requirements for substations from 225.70 in their entirety and relocated them at new 490.48(B).

The NEC also added new provisions documentation requirements for substations at 490.48(A).

Also new for the 2014 NEC are provisions for a permanent, single-line diagram of the switchgear to be provided in a readily visible location within the same room or enclosed area with the switchgear.

This diagram must also identify interlocks, isolation means, and all possible sources of voltage to the installation under normal or emergency conditions with companion markings on the switchgear itself.

The NEC also added a new exception to 490.48(C) to allow this diagram to be omitted where the equipment consists of a single cubicle or metal-enclosed unit substation containing only one set of high-voltage switching devices.

Conclusion

Summary

You have completed Chapter 4 of this course on *Changes in the 2014 NEC*.

Resources

References

NFPA. *2014 National Electrical Code (NEC)*, 2013.

International Association of Electrical Inspectors, Richardson, Texas and National Fire Protection Association, Inc. Quincy, MA. *Analysis of Changes – NEC 2014*, 2013.

The designations "National Electrical Code" and "NEC" refer to NFPA 70, National Electrical Code, which is a registered trademark of the National Fire Protection Association.

Author Biography

Neal L. Burdick

Neal Burdick has over 30 years of experience and is currently a construction inspector for the City of Tampa. He is a registered instructor for the Electrical Council of Florida and is the author and instructor of a State of Florida approved Electrical Contractor's Licensing Board course.

Neal is an accomplished and exceptionally knowledgeable professional with a solid background in electrical and building inspections, as well as code compliance. He is recognized as an expert in this industry. He is an active member of IAEI, BOAF, ECF, and related industry associations. Mr. Burdick conducts training to building officials, engineers, plans examiners, inspectors, electrical contractors, and apprentices throughout the State of Florida.

Attachment #2: Instructor Information

Course Instructor:

Neal Burdick

Florida Certified Electrical Contractor EC# 0002179

Mr. Burdick's resume is attached for review.

Neal L. Burdick
9840 Mainlands Blvd. West, Pinellas Park, FL 33782
Phone: 813-446-9848

PROFESSIONAL WORK HISTORY

CITY OF TAMPA, Tampa, FL 2005 – March 2013

Electrical / Construction Inspector II

Inspect all phases of electrical installations (residential, commercial, and industrial) permitted with the City of Tampa, to include underground, rough-in, and final inspections. Retrieve inspection requests, plan, and schedule, perform, and document an average of 18 to 25 field inspections daily. Verify on - site permit documentation and examine blueprints to ensure compliance with NEC and Florida Building Code requirements. Collaborate with contractors to identify and correct existing and potential deficiencies. Trained Building Inspectors on electrical segment of One / Two Family Dwelling Electrical Inspector examination; successfully tutored four Inspectors to secure their licenses.

CERTIFIED TEACHING / INSTRUCTION

PINELLAS COUNTY SCHOOL BOARD, Largo, FL 2011 - Present

Adult Education Trade Instructor (Tuesday / Thursday nights)

4th - year apprenticeship instructor for Bay Area Electrical Apprenticeship Program at Pinellas Technical Education Center (pTEC) Clearwater campus. Create lesson plans, curriculum, quizzes, and tests in preparation for the Electrical Journeyman Exam.

- Selected as keynote speaker for graduation banquet (2012).

BUILDING OFFICIALS ASSOCIATION OF FLORIDA, Lake Mary, FL 2009 – June 2012

Contract Instructor (volunteer)

Create and conduct Florida State - approved CEU classes for Building Officials, Plans Examiners, Engineers, Inspectors, and Contractors; class sizes range from 35 - 100 participants. Provide instruction at Chapter and Conference seminars throughout Florida; course topics include *Ethics in Construction*, *Photovoltaics*, and *National Electrical Code Updates*.

ELECTRICAL COUNCIL OF FLORIDA, Tampa, FL 2004 - Present

CEU Instructor/ Current Tampa Chapter President

Create and conduct Florida State - approved CEU code update classes throughout the state of Florida. Topics include: *Ethics in Construction*, *Prevention of False Alarms*, *Areas of Accessibility*, *Standby Generator Systems*, *National Electrical Code Updates*, *Laws & Rules for Construction Based on Florida Statutes*, and *Advanced Building Code Class*.

Instruct ECLB approved CEU classes to four local Chapters (4 - 6 times annually) and provide education at ECF State sponsored seminars (10 locations bi-annually); throughout the State of Florida.

- Certified through Construction Industry Licensing Board (CILB) and/or Electrical Contracting Licensing Board (ECLB) to conduct classes.

INDEPENDENT ELECTRICAL CONTRACTORS, Clearwater, FL 2006 - 2008

4th-Year Electrical Apprenticeship Instructor

Created lesson plans, quizzes, and exams.

- Lead 4th-year instructor; achieved 82% Journeymen Exam passing rate (27 students).

EDUCATION

Continuing Education Seminars and Code Update Classes through IAEI, BOAF and ECF

- *Network + (2002)*; graduated in the Top 3 of Class.
- *AutoCAD for the Professional 3D Rendering*; *AutoCAD for the Professional Level I/II*; *AutoCAD 2002*
- Pinellas Vocational Technical Institute, Clearwater, FL; *Programmable Logical Controllers (1998)*
Motor Controls (1981)
- *Charles J. Krasnoff Electrical Estimating Seminar*, Tampa, FL (1993)
- Bay Area Tech, Tampa, FL; *Electrical Estimating*
- *Masters Prep Course*
- Gibbs Sr High School, St. Petersburg, FL; Diploma/Graduated

Attachment #3: Course Materials and Fees

Course Material:

The course is reviewed online and is available to anyone who purchases it 24/7 as long as there is computer and internet access.

All material necessary to complete the course is included by viewing online. Students are not directed to additional material as a requirement for course completion, only as added information for personal interest.

Course Fee:

The fee for this course is \$44.85

Attachment #4: Schedule of Course Dates and Locations

This course is presented in an online format. The course is available at www.RedVector.com 24 hours a day, 7 days a week to anyone with computer and internet access.

SAMPLE

Certificate of Completion

John Doe

VA License #: 123456

has successfully completed the following course

2014 NEC Changes - Chapter 3 and Chapter 4 (RV-PGM102)

This online course is approved for 3 continuing education hours

XXXXXXXXXX

Course Approval



Matthew Casey, PhD, VP of Content

RedVector.com

AIA Registered Provider #J315

FL DBPR Approved Provider #0001771

FBPE Approved Provider #33

date of course completion

Course Completion Date

RedVector.

Online Education for Design and Construction

Two Urban Centre • 4890 West Kennedy Boulevard Suite 740 • Tampa, FL 33609

Attachment #6: Online/Correspondence Course Information

Security Procedures Utilized:

All students must register with the web site to gain access to their online course(s). The registration process creates a unique user profile and records their personal information including name, address, phone, email, username, password, licenses held, and license number(s). This information is automatically recorded and saved electronically.

We monitor required student participation in the course by logging and tracking the date and time a student enters a course, tracking activity during the course, and recording the date and time they complete the exam with a required passing score. If our learning management system detects 13-minutes of inactivity, a pop-up appears alerting the student that they must verify their presence or the session times out and the course closes.

In addition, at the completion of an exam, before it is graded, students are asked to confirm an affidavit indicating they personally completed the entire course. They must also confirm their identity before their exam is graded. This confirmation is stored in our database for audit purposes.

Once a student completes and passes the course with a grade of 70% or higher, they are given a certificate of completion and the course completion is recorded in their user profile, along with date and time completed.

End of Course Test:

A copy is attached for review.

Online Course Access:

The Board has been set up with a test account to preview courses on the RedVector.com website. To access the courses, please follow the directions below.

1. Log on to the web site at <http://www.RedVector.com>
2. On the top center of the page click the orange "Sign-In" button.
3. In the gray column labeled "Returning Users" enter your username **VAELEC** and your password **vaelec (both are case-sensitive)**. Click the "LOGIN" button.
4. You should arrive at the User Menu. Click on the second box "My Courses".
5. A list of courses will appear. Click on the title of the course you wish to begin and follow the instructions.

Final Exam: 2014 NEC Changes - Chapter 3: Wiring Methods and Materials (RV-10514)

1. 300.6 (A). Informational Note. Field-cut threads are those threads that are cut in _____ anywhere other than at the factory where the product is listed.
 - A. Conduit
 - B. Elbows
 - C. Nipples
 - D. All of the above

2. 300.11. Raceways shall be used only as a means of support for other raceways, cables, or nonelectrical equipment under which of the following conditions?
 - A. Where the raceway or means of support is identified for the purpose as a means of support
 - B. Where the raceway contains power supply conductors for electrically controlled equipment and is used to support Class 3 circuit conductors or cables that are solely for the purpose of connection to the equipment control circuits
 - C. Where the raceway is used to support boxes or conduit bodies in accordance with 314.23 or to support luminaires in accordance with 410.36(E).
 - D. Items a and c

3. 300.22 (C) (1). Cable ties used to secure cables in plenums must be listed as having fire-resistant and low-smoke producing characteristics.
 - A. TRUE
 - B. FALSE

4. 300.38. Where raceways are installed in wet locations above grade, the interior of these raceways shall be considered to be a _____ location.
 - A. Dry location
 - B. Wet location
 - C. Damp location
 - D. None of the above

5. 310.10 (H) (2) and (6). Informational Note. Where conductors are paralleled in enclosures or raceways, failure to group one conductor from each phase in each raceway or grouping within a wiring method may result in:
 - A. Shorts
 - B. Fire
 - C. Overheating and current imbalance.
 - D. All of the above

6. 310.15 (B) (7). This revision deletes Table 310.15(B)(7) and replaces it with a provision allowing an ____ revision in ampacity for dwelling service and feeder conductors.

- A. 50%
- B. 60%
- C. 83%
- D. 90%

7. 314.15. Approved drainage openings not larger than _____ shall be permitted to be installed in the field in boxes or conduit bodies listed for use in damp or wet locations.
- A. 1/2 in.
 - B. 1/4 in.
 - C. 3/8 in.
 - D. none of the above
8. 314.23(B) (B). An enclosure supported from a structural member of a building or from grade shall be rigidly supported either directly or by using a _____.
- A. Metal brace
 - B. Polymeric brace
 - C. Wood brace
 - D. Any of the above
9. 314.25. The NEC now specifies that drywall screws are not permitted to be used to attach box covers or other equipment fastened to a box.
- A. TRUE
 - B. FALSE
10. 314.27 (A) (2). Outlet boxes used to support ceiling-mounted luminaires that weigh more than _____ are now required to be marked, on the interior of the box, with the maximum weight the box will support.
- A. 20 lb
 - B. 30 lb
 - C. 40 lb
 - D. 50 lb
11. 324.41. Carpet squares that cover flat conductor cable (Type FCC) are now required to be no larger than _____ square.
- A. 20 in.
 - B. 30 in
 - C. 39.37 in.
 - D. 34 in.
12. 330.30 (B). Listed Type MC cable with ungrounded conductors 250 kcmil and larger is now permitted to be secured in intervals not exceeding _____ for vertical installations.
- A. 10 ft.
 - B. 12 ft.
 - C. 15 ft.
 - D. 20 ft.

13. 330.30 (D) (3). The NEC now permits Type MC cable to be installed unsupported in lengths not exceeding 900 mm _____ where necessary for vibration reasons or flexibility.
- A. 3.5 ft
 - B. 4 ft.
 - C. 5 ft.
 - D. 3 ft.
14. 334.40 (B). Nonmetallic-sheathed cable interconnectors have been recognized to be used without a box and concealed where used for "repair wiring" rather than "rewiring" in existing buildings.
- A. TRUE
 - B. FALSE
15. 344.100. RMC shall be made of one of the following:
- A. Steel (ferrous), with or without protective coatings
 - B. Aluminum (nonferrous)
 - C. Red Brass or Stainless Steel
 - D. Any of the above
16. 350.42. The NEC now specifies that only fittings listed for use with liquidtight flexible metal conduit (LFMC) shall be used with LFMC.
- A. TRUE
 - B. FALSE
17. 356.12 (3) LFNC shall not be used in lengths longer than _____, except as permitted by 356.10 (5) or where a longer length is approved as essential for a required degree of flexibility
- A. 3 ft.
 - B. 4 ft.
 - C. 6 ft.
 - D. 5 ft.
18. 376.22 (B). Ampacity adjustment factors for more than three current-carrying conductors in a raceway shall only apply to metal wireways where the number of current-carrying conductors exceeds _____ at any cross section of the wireway.
- A. 20
 - B. 30
 - C. 40
 - D. 50
19. 376.56 (B) (1) (5). The NEC now states that power distribution blocks installed in wireways ahead of the service main (line side) must be listed for the purpose.
- A. TRUE
 - B. FALSE

20. 392.10. Cable tray shall be permitted to be used as a support system for service conductors, feeders, branch circuits, communications circuits, control circuits, and signaling circuits. Cable tray installations:
- A. Shall not be limited to industrial establishments
 - B. Shall be limited to industrial establishments
 - C. Both a and b
 - D. None of the above
21. 348.30 Under "Exception No. 4" listed ___ conduit fittings shall be permitted as a means of support.
- A. Flexible Metal
 - B. Ridged Metal
 - C. Nonmetallic
 - D. All of the above
22. 370.80 The ampacity of conductors in a cablebus shall be in accordance with Table 310.15(B)(17) and Table 310.15(B)(19) for installations up to and including ___ volts.
- A. 500
 - B. 1000
 - C. 1500
 - D. 2000
23. 386.120 The NEC added a new product marking requirement at 386.120 for surface metal raceway. The addition of this new requirement provides consistency with other articles within the Code for similar products.
- A. True
 - B. False
24. 393. A new article was added to address low-voltage Class ___ equipment connected to ceiling grids and walls constructed for this purpose.
- A. 1
 - B. 2
 - C. 3
 - D. 4
25. 399.2 Why were the words "in free air" added to the definition of Outdoor Overhead Conductors?
- A. To ensure that the definition clearly indicated that wiring installed under article 399 was not installed in raceways.
 - B. To ensure that the definition clearly indicated that wiring installed under article 399 was not installed in feeder conductors.
 - C. To ensure that the definition clearly indicated that wiring installed under article 399 was not installed in GFCI breakers.
 - D. To ensure that the definition clearly indicated that wiring installed under article 399 was not installed in GFCI breakers.

Final Exam: 2014 NEC Changes - Chapter 4: Equipment for General Use (RV-10515)

1. 400.6 (A). The 2014 NEC now requires an additional marking on tags, cords and cables. This new marking consists of:
 - A. The maximum operating temperature of the flexible cord or cable.
 - B. The maximum required voltage
 - C. The AWG size or circular mil area
 - D. The manufacturer's name

2. 404.2 (C). Which statement below is not correct? The grounded circuit conductor for the controlled lighting circuit shall be provided at the switch location where switches control lighting loads that are supplied by a grounded general purpose branch circuit for other than the following (Partial list):
 - A. Where conductors enter the box enclosing the switch through a raceway, provided that the raceway is large enough for all contained conductors, including a grounded conductor
 - B. Where the box enclosing the switch is accessible for the installation of an additional or replacement cable without removing finish materials.
 - C. Where a switch does not serve a habitable room or bathroom.
 - D. Where lighting in the area is controlled by manual means.

3. 404.8 (C). The 2014 NEC now permits multipole snap switches that are rated not less than the system voltage (whether listed for multiple circuits or not) to be fed from more than a single circuit.
 - A. TRUE
 - B. FALSE

4. 406.4 (D). In addition to the replacement receptacle requirements of the previous edition of the Code, the 2014 NEC now requires arc-fault circuit-interrupter (AFCI) and ground-fault circuit-interrupter (GFCI) type replacement receptacles to be installed:
 - A. In a concealed location
 - B. In a readily accessible location
 - C. Above the appliance
 - D. Any of the above

5. 406.5. (F). In seating areas or similar surfaces, receptacles shall not be installed in a face-up position unless the receptacle is any of the following:
 - A. Part of an assembly listed as a furniture power distribution unit, if cord-and-plug-connected
 - B. Part of an assembly listed either as household furnishings or as commercial furnishings
 - C. Listed either as a receptacle assembly for countertop applications or as a GFCI receptacle assembly for countertop applications.
 - D. Any of the above.

6. 406.9 (B) (1). Receptacles of 15 and 20 amperes installed in a wet location shall have an enclosure that is weatherproof whether or not the attachment plug cap is inserted. An outlet box hood installed for this purpose shall be:
 - A. Listed
 - B. Identified as "extra duty
 - C. Listed weather-resistant type.
 - D. All of the above

7. 406.12 (C) Exception to (A), (B), and (C) (1). Receptacles in the following locations shall not be required to be tamper-resistant:
 - A. Receptacles located more than (4 ½ ft) above the floor.
 - B. Receptacles located more than (4 ft) above the floor.
 - C. Receptacles located more than (5 ½ ft) above the floor.
 - D. None of the above

8. 406.15. The NEC now permits specific receptacles to be controlled by a dimmer under specific conditions. A receptacle supplying lighting loads can be connected to a dimmer if:
 - A. The plug/receptacle combination is a nonstandard configuration type
 - B. The plug/receptacle is specifically listed and identified for each such unique combination
 - C. Both a and b
 - D. None of the above

9. 408.3 (E) (1). AC phase arrangement on 3-phase buses shall be A, B, C from _____, as viewed from the front of the switchboard, switchgear, or panelboard.
 - A. Front to back
 - B. Top to bottom
 - C. Left to right
 - D. Any of the above

10. 408.4 (B). The NEC added a revision to indicate that switchboards, switchgear, and panelboards can have more than one source of power.
 - A. TRUE
 - B. FALSE

11. 409.20. The size of the industrial control panel supply conductor shall have an ampacity not less than _____ percent of the full-load current rating of all heating loads plus 125 percent of the full-load current rating of the highest rated motor plus the sum of the full-load current ratings of all other connected motors and apparatus based on their duty cycle that may be in operation at the same time.
 - A. 90 percent
 - B. 95 percent
 - C. 100 percent
 - D. 125 percent

12. 410.10 (F). The NEC no longer permits luminaires to be installed within _____ of the lowest metal deck surface.
 - A. .5 in
 - B. .75 in
 - C. 1 1/2 in
 - D. None of the above

13. 422.5. A change in the 2014 NEC now requires GFCI devices providing protection to appliances in Article 422 to be:
 - A. Listed
 - B. Installed in readily accessible locations
 - C. Tested
 - D. Maintained

14. 422.11 (F) (3). Resistance-type immersion electric heating elements shall be permitted to be subdivided into circuits not exceeding 120 amperes and protected at not more than 150 amperes as follows:
 - A. Where contained in ASME rated and stamped vessels
 - B. Where included in listed instantaneous water heaters
 - C. Where installed in low-pressure water heater tanks or open outlet water heater vessels
 - D. All of the above

15. 422.23. The 2014 NEC now requires GFCI protection for all tire inflation and automotive vacuum machines provided for public use.
 - A. TRUE
 - B. FALSE

16. 424.66 (B). Where the enclosure is located in a space above a ceiling, which of the following applies?
 - A. The enclosure shall be accessible through a lay in type ceiling or access panel(s).
 - B. The width of the working space shall be the width of the enclosure or a minimum of 762 mm (30 in.), whichever is greater.
 - C. All doors or hinged panels shall open to at least 90 degrees.
 - D. All of the above shall apply

17. 430.53 (D) (2). No conductor to the motor shall have an ampacity less than one-third that of the branch-circuit conductors, with a minimum in accordance with 430.22. The conductors from the point of the tap to the motor overload device shall be not more than _____ long and be protected from physical damage by being enclosed in an approved raceway or by use of other approved means.
 - A. 30 ft
 - B. 35 ft
 - C. 25 ft
 - D. Any of the above

18. 430.233. The minimum voltage levels for live parts of motors or controllers requiring guarding against accidental contact by insulating mats or platforms were lowered from 150 volts to ground to _____ volts to ground.
- A. 25 volts
 - B. 50 volts
 - C. 70 volts
 - D. 100 volts
19. 445.20. Which statement below is correct? All 125-volt, single-phase, 15-and 20 ampere receptacle outlets, that are a part of a 15 kW or smaller, portable generator, either shall have:
- A. Ground-fault circuit interrupter protection for personnel integral to the generator or receptacle
 - B. Shall not be available for use when the 125/250 volt locking-type receptacle is in use.
 - C. If the generator does not have a 125/250 volt locking-type receptacle, this requirement shall not apply.
 - D. All of the above
20. 450.10 Grounding. The NEC no longer permits a grounding and bonding terminal bar in transformer enclosures to be installed on or over the vent screen portion of the enclosure.
- A. TRUE
 - B. FALSE
21. 450.11 What was the reason for the changes to the language for marking nameplates on transformers?
- A. The language was adjusted to include information on energy saving requirements.
 - B. The language was shortened so the nameplates could fit into a smaller space on the transformers.
 - C. The language was expanded to give a more comprehensive list of general information.
 - D. The language was formatted into a more user-friendly list format.
22. 480.9 (D) Top Terminal Batteries, under battery locations: this subsection addresses working space requirements for top-terminal batteries and gives the option to install them to individual specifications.
- A. True
 - B. False
23. 490.48 NEC removed requirements for substation from 225.70 and relocated them to what new section?
- A. 490.48(A)
 - B. 490.48(B)
 - C. 490.48(C)
 - D. 490.48(D)
24. 445.18 What disconnecting means was added as acceptable for portable generators?

- A. Cord and Plug
- B. Cord
- C. Plug
- D. Cable and Cord

25. 410.1 Extensive upgrades are underway in lighting and sign industries to achieve great energy efficiency in luminaires and signs by replacing in-place systems with:
- A. Fiber optics
 - B. Parabolic Aluminized Reflectors (PAR)
 - C. Light emitting diodes (LED)
 - D. Mini Halogens

Attachment #1: Course Syllabus

Course Title:

2014 NEC Changes - Chapter 5 and Chapter 6 (RV-PGM103)

Course Hours:

3 hours

Course Instructor:

Neal Burdick

Course Description:

The 2014 NEC provides an accurate, reliable, and authoritative account of the hundreds of significant revisions in the 2014 Code.

This course provides coverage of significant changes in the 2014 National Electrical Code®. With every new edition of the NEC, some of the changes include new requirements to sections, while some of the changes include entirely new articles. Some changes are revisions to existing requirements while others are deletions to some existing requirements.

Chapter 5 is the first of three NEC chapters dealing with special topics.

Special Occupancy is a location where the facility or use of the physical facility creates specific conditions that require additional measures to ensure the “practical safeguarding of people and property” consistent with the purpose of the NEC.

Chapter 6, which covers electrical signs and outline lighting, is the second of three NEC chapters that deal with special topics. Special Equipment is equipment that, by the nature of its use, construction, or by its unique nature creates a need for additional measures to ensure the mission of the NEC “Safeguarding of people and property”.

NOTE: This course is formatted in 2 lessons with the exam given at the end of each lesson. Each lesson must be passed with a score of 70% or higher before being allowed to proceed to the next lesson. The lessons are listed below:

Lesson 1: 2014 NEC Changes - Chapter 5: Special Occupancies

Lesson 2: 2014 NEC Changes - Chapter 6: Electric Signs and Outline Lighting

Course Objectives:

By the end of this course, you will be able to:

- Define what an intrinsically safe system is and how it applies to the NEC® changes to Article 504
- Identify the categories for building systems in healthcare facilities that focus on a risk-based approach for patients
- Identify the safety reasons for the addition of aluminum equipment grounding conductors in agricultural applications
- Recognize the provisions that are considered necessary for the safety of the public.
- Describe the characteristics for ground-fault circuit-interrupter protection for safe personal use

Lesson 1 Outline:

Introduction

ARTICLE 500 Hazardous (Classified) Locations, Classes 1, II, and III, Divisions 1 and 2

- 501.40 Multiwire Branch Circuits and Exception

ARTICLE 504 Intrinsically Safe Systems

- 504.1 Scope

ARTICLE 514 Motor Fuel Dispensing Facilities

- 514.1 Scope

ARTICLE 516 Spray Application, Dipping, Coating, and Printing Processes Using Flammable Combustible Materials

- 516.1 Scope

ARTICLE 517 Health Care Facilities

- 517.1 Scope
- 517.2 Definitions
- 517.16 Use of Isolated Ground Receptacles
- 517.18 General Care Areas
- 517.19 Critical Care Areas
- 517.30 Essential Electrical Systems for Hospitals

ARTICLE 520 Theaters, Audience Areas of Motion Picture and Television Studios, Performance Areas, and Similar Locations

- 520.1 Scope & 520.2 Definitions

ARTICLE 547 Agricultural Buildings

- 547.1 Scope & 547.2 Definitions
- 547.5 Wiring Methods

ARTICLE 550 Mobile Homes, Manufactured Homes, and Mobile Home Parks

- 550.1 Scope & 550.15 Wiring Methods and Materials

ARTICLE 551 Recreational Vehicles and Recreational Vehicle Parks

- 551.1 Scope & 551.4 General Requirements
- 551.71 Type Receptacles Provided. (Recreational Vehicle Parks)

ARTICLE 555 Marinas and Boatyards

- 555.1 Scope & 555.15 Grounding

ARTICLE 590 Temporary Installations

- 590.1 Scope & 590.4 General

Conclusion

Lesson 2 Outline:

Introduction

ARTICLE 600 - Electric Signs and Outline Lighting

- 600.1 Scope & 600.4 Markings
- 600.6 Disconnects
- 600.7 Grounding and Bonding

ARTICLE 610 Cranes and Hoists

- 610.1 Scope & 610.31 Runway Conductor Disconnecting Means. (Cranes and Hoists)

ARTICLE 620 Elevators, Dumbwaiters, Escalators, Moving Walks, Platform Lifts, and Stairway Chairlifts

- 620.1 Scope & 620.21 Wiring Methods (Elevators, Escalators, Etc.)
- 620.51 Disconnecting Means

ARTICLE 625 Electric Vehicle Charging System

- 625.1 Scope

ARTICLE 630 Electric Welders

- 630.1 Scope & 630.13 Disconnecting Means

ARTICLE 645 Information Technology Equipment

- 645.1, 645.14, 645.15
- 645.27 Selective Coordination

ARTICLE 646 Modular Data Centers

- 646.1 Scope

ARTICLE 680 Swimming Pools, Fountains, and Similar Installations

- 680.1 Scope & 680.2 Definitions
- 680.12 Maintenance Disconnecting Means
- 680.21 Motors
- 680.22 Lighting, Receptacles, and Equipment
- 680.25 Feeders
- 680.26 Equipotential Bonding
- 680.42 Outdoor Installations
- 680.57 Signs

ARTICLE 690 Solar Photovoltaic (PV) Systems

- 690.1 Scope & 690.2 Definitions
- 690.5 Ground-Fault Protection
- 690.7 Maximum Voltage
- 690.9 Overcurrent Protection
- 690.10 Stand-Alone Systems
- 690.12 Rapid Shutdown of PV Systems on Buildings
- 690.31 Methods Permitted
- 690.35 Ungrounded Photovoltaic Power Systems
- 690.41 System Grounding
- 690.47 Grounding Electrode System
- 690.81 Listing

Article 694 Wind Electric Systems

- 694.1 Scope

Conclusion



2014 NEC Changes - Chapter 5: Special Occupancies

Table of Contents

Introduction	4
Course Overview	4
Learning Objectives	4
ARTICLE 500 Hazardous (Classified) Locations, Classes I, II, and III, Divisions 1 and 2	6
501.40 Multiwire Branch Circuits and Exception	6
ARTICLE 504 Intrinsically Safe Systems.....	6
504.1 Scope	6
ARTICLE 514 Motor Fuel Dispensing Facilities.....	7
514.1 Scope	7
ARTICLE 516 Spray Application, Dipping, Coating, and Printing Processes Using Flammable Combustible Materials.....	8
516.1 Scope	9
ARTICLE 517 Health Care Facilities	9
517.1 Scope	9
517.2 Definitions.....	10
517.16 Use of Isolated Ground Receptacles.....	12
517.18 General Care Areas.....	13
517.19 Critical Care Areas.....	14
517.30 Essential Electrical Systems for Hospitals.....	16
ARTICLE 520 Theaters, Audience Areas of Motion Picture and Television Studios, Performance Areas, and Similar Locations.....	18
520.1 Scope & 520.2 Definitions.....	18
ARTICLE 547 Agricultural Buildings.....	19
547.1 Scope & 547.2 Definitions.....	19
547.5 Wiring Methods.....	20
ARTICLE 550 Mobile Homes, Manufactured Homes, and Mobile Home Parks.....	21
550.1 Scope & 550.15 Wiring Methods and Materials	21
ARTICLE 551 Recreational Vehicles and Recreational Vehicle Parks	22
551.1 Scope & 551.4 General Requirements.....	22
551.71 Type Receptacles Provided. (Recreational Vehicle Parks)	23
ARTICLE 555 Marinas and Boatyards	24
555.1 Scope & 555.15 Grounding.....	24
ARTICLE 590 Temporary Installations	25

2014 NEC Changes - Chapter 5: Special Occupancies

590.1 Scope & 590.4 General.....25
Conclusion.....26
Summary.....27
Resources.....28
References.....28
Author Biography.....29
Neal L. Burdick.....29

Introduction

Course Overview

This is the **fifth** of several courses covering the changes in the 2014 edition of the **National Electrical Code** (NEC) created by the NFPA. The 2014 NEC provides an accurate, reliable, and authoritative account of the hundreds of significant revisions in the 2014 Code.

This course provides coverage of significant changes in the *2014 National Electrical Code*. With every new edition of the NEC, some of the changes include new requirements to sections, while some of the changes include entirely new articles. Some changes are revisions to existing requirements while others are deletions to some existing requirements.

Although not required, **it is recommended to have a copy of the 2014 NEC manual for reference**, especially when reviewing information in large tables.

A **Summary of each change** is followed by the actual NEC Language, with deletions showing with a ~~strike through~~ and additions/changes (highlighted in yellow). When necessary, **Comments** are added to appropriate topics.

In many cases, paragraphs not directly affected by a change are retained to preserve context. *There will be no quiz questions on material that does not cover changes in the 2014 NEC.*

The length of each segment varies depending on the topic and material available.

The National Electrical Code is intended for electricians and subcontractors, electrical inspectors, electrical engineers, designers, and other qualified persons who understand electrical currents, theory, safety procedures, and electrical trade practices. The code does not serve as a teaching manual for untrained individuals.

Chapter 5 is the first of three NEC chapters dealing with special topics.

Special Occupancy is a location where the facility or use of the physical facility creates specific conditions that require additional measures to ensure the "practical safeguarding of people and property" consistent with the purpose of the NEC.

Learning Objectives

By the end of this course, you will be able to:

- Identify the various significant changes in Chapter 5 of the NEC
- Recognize that this NEC contains provisions that are considered necessary for safety and compliance therewith and proper maintenance results in an installation that is essentially free from hazard.
- Refer to the appropriate sections of the code and find applicable changes and information
- Define what an intrinsically safe system is and how it applies to the NEC changes to Article 504

2014 NEC Changes - Chapter 5: Special Occupancies

- Explain the revision that is critical to a safe working environment in and around spray application, dipping, and coating, and printing processes using flammable or combustible materials
- Identify the categories for building systems in healthcare facilities that focus on a risk-based approach for patients
- Explain the safety changes that were implemented for receptacles in operating rooms
- Describe the requirements for receptacle markings and identification
- Identify the safety reasons for the addition of aluminum equipment grounding conductors in agricultural applications
- Explain the reason for the standardization to safety label requirements for recreational vehicles and recreation vehicle parks

ARTICLE 500 Hazardous (Classified) Locations, Classes I, II, and III, Divisions 1 and 2
501.40 Multiwire Branch Circuits and Exception

Articles 500 through 504 cover the requirements for electrical and electronic equipment and wiring for all voltages in Class I, Divisions 1 and 2; Class II, Divisions 1 and 2; and Class III, Divisions 1 and 2 locations where fire or explosion hazards may exist due to flammable gases, flammable liquid-produced vapors, combustible liquid-produced vapors, combustible dusts, or ignitable fibers/flyings.

Changed From NEC 2011

The 2014 NEC deleted Section 501.40 and the associated exception dealing with multiwire branch circuits in Class I, Division 1.

NEC Language

~~501.40 Multiwire Branch Circuits~~

~~In a Class I, Division 1 location, a multiwire branch circuit shall not be permitted.~~

~~**Exception:** Where the disconnect device(s) for the circuit opens all ungrounded conductors of the multiwire circuit simultaneously.~~

Comments

The reason for the deletion of NEC 501.40 and the exception is that the requirements for simultaneous disconnection of all ungrounded conductors of multiwire branch circuits are already provided at 210.4(B).

Further deletions of text with very similar requirements for multiwire branch circuits were done at the following locations:

502.40 Class II, Division 1 Locations Proposal 14-92

505.21 Class I, Zone 1 Locations Proposal 14-184

506.21 Zone 20 and Zone 21 Locations Proposal 14-255a

ARTICLE 504 Intrinsically Safe Systems

504.1 Scope

This article covers the installation of intrinsically safe (I.S.) apparatus, wiring, and systems for Class I, II, and III locations.

Changed From NEC 2011

The NEC revised Article 504 to align with intrinsically safe products standards.

NEC Language

Article 504 Intrinsically Safe Systems

504.1 Scope

504.2 Definitions

2014 NEC Changes - Chapter 5: Special Occupancies

504.3 Application of Other Articles

504.4 Equipment

504.10 Equipment Installation

504.20 Wiring Methods

504.30 Separation of Intrinsically Safe Conductors

504.50 Grounding

504.60 Bonding

504.70 Sealing

504.80 Identification

(Please see your copy of the NEC for the complete text)

Comments

An intrinsically safe system is defined as, "*an assembly of interconnected intrinsically safe apparatus, associated apparatus, and interconnecting cables, in that those parts of the system that may be used in hazardous (classified) locations are intrinsically safe circuits.*"

The revisions in Article 504 align with intrinsically safe products standards such as *ANSI/ISA-60079-11 Explosive Atmospheres – Part 11* and *ANSI/UL 913 Standard for Safety, Intrinsically Safe Apparatus and Associated Apparatus for Use in Class I, II, and III, Division 1, Hazardous (Classified) Locations.*

For consistency, the NEC also deleted some duplication within Article 504, such as 504.20 for "*Wiring Methods.*"

The NEC added a new 504.10(C) for general-purpose enclosures containing intrinsically safe apparatus and associated apparatus, and removed duplicate text from 504.10(B). A new 504.10(D) entitled, "Simple Apparatus" is due to the deletion of matching text at 504.10(B) that deals with the locations of intrinsically safe apparatus.

ARTICLE 514 Motor Fuel Dispensing Facilities

514.1 Scope

This article shall apply to motor fuel dispensing facilities, marine/motor fuel dispensing facilities, motor fuel dispensing facilities located inside buildings, and fleet vehicle motor fuel dispensing facilities.

Changed From NEC 2011

Table 514.3(B)(1), Footnote 2 and Figures 514.3(a) and 514.3(b)

Footnote 2 that follows Table 514.3(B)(1) now references Figure 514.3(a) and a new Figure 514.3(b).

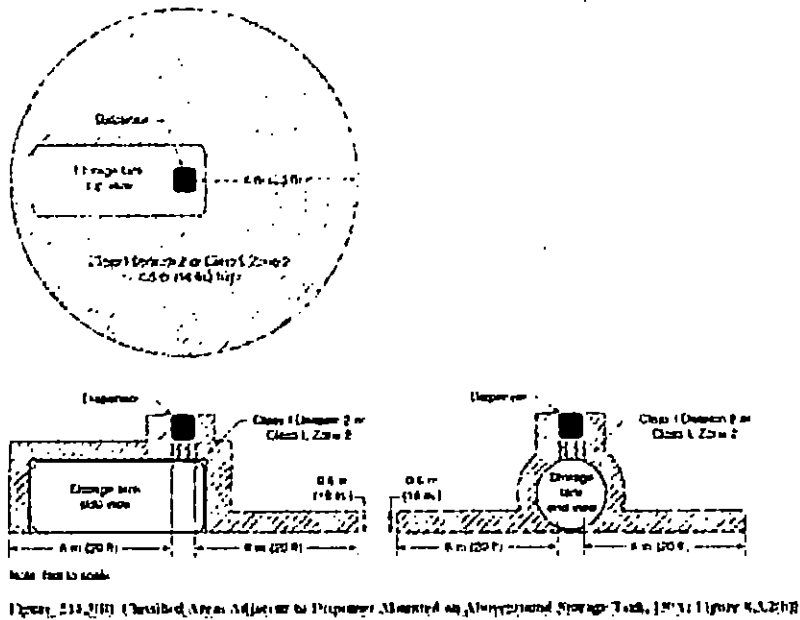

Source: NEC 2014

NEC Language

ARTICLE 514 Motor Fuel Dispensing Facilities

Locations – Motor Fuel Dispensing Facilities

Footnote 2 to Table:

Refer to **Figure 514.3(a)** and **Figure 514.3(b)** for an illustration of classified location around dispensing devices.

Figure 514.3(a)

Classified Areas Adjacent to Dispensers as Detailed in Table 514.3(B)(1). [30A: Figure 8.3.2(a)]

Figure 514.3(b) Classified Areas Adjacent to Dispenser Mounted on Aboveground Storage Tank [30A: Figure 8.3.2(b)]

Please use your copy of the NEC for complete Tables and Figures.

Comments

The NEC added a new Figure 514.3(b) in Article 514 and this is referenced at Table 514.3(B)(1), Footnote 2.

There is also an update at the existing Figure 514.3(a) and the new Figure 514.3(b) to reflect the information at Figure 8.3.2(a) and Figure 8.3.2(b) of *NFPA 30A, Code for Motor Fuel Dispensing Facilities and Repair Garages*.

The new Figure 514.3(b) illustrates classified areas adjacent to dispensers mounted on above ground storage tanks.

ARTICLE 516 Spray Application, Dipping, Coating, and Printing Processes Using Flammable Combustible Materials

516.1 Scope

Informational Note: Text that is followed by a reference in brackets has been extracted from NFPA 33-2011, Standard for Spray Application Using Flammable and Combustible Materials, or NFPA 34-2011, Standard for Dipping, Coating, and Printing Processes Using Flammable or Combustible Liquids. Only editorial changes were made to the extracted text to make it consistent with this Code.

This article covers the regular or frequent application of flammable liquids, combustible liquids, and combustible powders by spray operations and the application of flammable liquids, or combustible liquids at temperatures above their flashpoint, by dipping, coating, printing, or other means.

Changed From NEC 2011

The 2014 NEC revised and reorganized Article 516, including a new title of "*Spray Application, Dipping, and Coating, and Printing Processes Using Flammable or Combustible Materials.*"

NEC Language

(Please use your copy of the 2014 NEC to review the complete text.)

Comments

The revision of Article 516 is critical to a safe working environment in and around spray application, dipping, and coating, and printing processes using flammable or combustible materials.

The NEC revised Article 516 to correlate with the 2011 editions of *NFPA 33 Standard for Spray Application Using Flammable and Combustible Materials* and *NFPA 34 Standard for Dipping, Coating, and Printing Processes Using Flammable or Combustible Liquids*.

This reflects the importance of preventing fire and explosion through proper maintenance and operation of processes and process area where flammable and combustible materials are handled and applied.

ARTICLE 517 Health Care Facilities

517.1 Scope

Informational Note: Text that is followed by a reference in brackets has been extracted from NFPA 99-2012, Health Care Facilities Code, and NFPA 101-2012, Life Safety Code. Only editorial changes were made to the extracted text to make it consistent with this Code.

I. General

The provisions of this article shall apply to electrical construction and installation criteria in health care facilities that provide services to human beings.

The requirements in Parts II and III not only apply to single-function buildings but are also intended to be individually applied to their respective forms of occupancy within a multifunction building (e.g., a doctor's examining room located within a limited care facility would be required to meet the provisions of 517.10).

Informational Note: For information concerning performance, maintenance, and testing criteria, refer to the appropriate health care facilities documents.

517.2 Definitions.

The NEC revised, deleted, or added several definitions in Article 517.

NEC Language

Critical Branch

~~A subsystem of the emergency system consisting of feeders and branch circuits supplying energy to power for task illumination, special power circuits, fixed equipment, select receptacles, and select power circuits serving areas and functions related to patient care and that are is connected to alternate power sources by one or more transfer switches during interruption of normal power source.~~

Here is the cleaned-up definition to make it easier to read:

A system of feeders and branch circuits supplying power for task illumination, fixed equipment, select receptacles, and select power circuits serving areas and functions related to patient care and that is automatically connected to alternate power sources by one or more transfer switches during interruption of normal power source.

Emergency System

~~A system of circuits and equipment intended to supply alternate power to a limited number of prescribed functions vital to the protection of life and safety.~~

Equipment Branch

Equipment System Branch

A system of feeders and branch circuits ~~and equipment~~ arranged for delayed, automatic, or manual connection to the alternate power source and that serves primarily 3-phase power equipment.

Life Safety Branch

~~A subsystem of the emergency system consisting of feeders and branch circuits, meeting the requirements of Article 700 and intended to provide adequate power needs to ensure safety to patients and personnel, and supplying power for lighting, receptacles, and equipment essential for life safety that are is automatically connected to alternate power sources by one or more transfer switches during interruption of the normal power source.~~

Here is the cleaned-up definition to make it easier to read:

A system of feeders and branch circuits supplying power for lighting, receptacles, and equipment essential for life safety that is automatically connected to alternate power sources by one or more transfer switches during interruption of the normal power source.

Patient Care Area Space

Patient Care Area Space

~~Any portion of Space within a health care facility wherein patients are intended to be examined or treated. Areas of a health care facility in which patient care is administered are classified as general care areas or critical care areas. The governing body of the facility designates these~~

~~areas in accordance with the type of patient care anticipated and with the following definitions of the area classification.~~

Here is the cleaned-up definition to make it easier to read:

Space within a health care facility wherein patients are intended to be examined or treated.

Basic Care Space

Basic Care Area Space

Space in which failure of equipment or a system is not likely to cause injury to the patients or caregivers but may cause patient discomfort.

General Care Space

General Care Area Space

~~Patient bedrooms, examining rooms, treatment rooms, clinics, and similar areas in which it is intended that the patient will come in contact with ordinary appliances such as a nurse call system, electric beds, examining lamps, telephones, and entertainment devices.~~

Space in which failure of equipment or a system is likely to cause minor injury to patients or caregivers.

Critical Care Space

Critical Care Areas Space

~~These special care units, intensive care units, coronary care units, angiography laboratories, cardiac catheterization laboratories, delivery rooms, operating rooms, and similar areas in which patients are intended to be subjected to invasive procedures and connected to line-operated, electromedical devices. Space in which failure of equipment or a system is likely to cause major injury or death to patients or caregivers.~~

Wet Procedure Locations

~~Wet Procedure Locations~~

~~This was deleted from the definition of *Patient Care Space*.~~

Support Space

Support Space

Space in which failure of equipment or a system is not likely to have a physical impact on patients or caregivers.

Patient Care Vicinity

~~In an area in which patients are normally cared for, the patient care vicinity is the space with surfaces likely to be contacted by the patient or an attendant who can touch the patient. A space, within a location intended for the examination and treatment of patients, extending 1.8 m (6 ft) beyond the perimeter of the bed in its nominal location normal location of the patient bed, chair, table, treadmill, or other device that supports the patient during examination and treatment and extending vertically to 2.3 m (7 ft 6 in.) above the floor.~~

Here is the cleaned-up definition to make it easier to read:

A space, within a location intended for the examination and treatment of patients, extending 1.8 m (6 ft) beyond the normal location of the patient bed, chair, table, treadmill, or other device that

supports the patient during examination and treatment and extending vertically to 2.3 m (7 ft 6 in.) above the floor.

Wet Procedure Location

The area in a patient care space where a procedure is performed that is normally subject to wet conditions while patients are present, including standing fluids on the floor or drenching of the work area, either of which condition is intimate to the patient or staff.

Informational Note: Routine housekeeping procedures and incidental spillage of liquids do not define a wet procedure location. [ROP 15–24]

(Please use your copy of the 2012 NEC and 517.2 for the complete text)

Comments

The 2014 NEC revised several definitions in order to coordinate the NEC —and, in particular, Article 517— with NFPA 99.

Some of the revisions were due to the re-organization of the “*Essential Electrical System*” of a hospital. This eliminates the term *emergency system*, leaving only the essential system with the three separate branches: the **critical**, the **life safety**, and the **equipment branch**.

517.16 Use of Isolated Ground Receptacles

The 2014 NEC does not permit isolated grounding type receptacles within a patient care vicinity (rather than the entire health care facility).

NEC Language

517.16 Use of Isolated Ground Receptacles with Insulated Grounding Terminals.

~~An Receptacles with insulated grounding receptacle terminals, as permitted in 250.146(D), shall not be permitted installed within a patient care vicinity.~~

Here is the cleaned-up version:

An isolated ground receptacle shall not be installed within a patient care vicinity.

Comments

The NEC condensed the requirement to prohibit isolated ground receptacles in health care facilities. Now it only prohibits these receptacles from the patient care vicinity of a health care facility.

The previous language at 517.16 would prohibit the use of isolated ground receptacles in the entire health care facility.

Section 517.16 is located in Part II of Article 517 and, as such, applies to the entire health care facility.

Listed cord- and plug-connected medical instrumentation used in health care facilities outside of patient care vicinities, typically at nurses’ monitoring stations, often require connection to isolated ground receptacles to insure measurement accuracy by mitigating electrical noise or interference, which is essential to patient medical safety.

Allowing isolated ground receptacles away from patient care vicinity enables this mitigation against equipment interference without affecting patient safety.

The issue and concern with isolated ground receptacles within patient care vicinity is the assurance of the equipment grounding conductor redundancy requirement of 517.13(A) and (B) for wiring methods at patient care vicinity.

This "redundant grounding" provision in a patient care space or area requires two equipment grounding paths to always insure one is functioning at all times. This is usually accomplished with a wire-type equipment grounding conductor within a metallic wiring method that meets the equipment grounding conductor provisions of 250.118.

This redundant grounding provision cannot be accomplished with an isolated ground receptacle.

517.18 General Care Areas

(A) Patient Bed Location

The NEC now requires all receptacles or the cover plate supplied from the critical branch to have a distinctive color or marking so as to be readily identifiable.

Marking also needs to indicate the panel board and branch circuit number supplying them.

NEC Language

(A) Patient Bed Location

Each patient bed location shall be supplied by at least two branch circuits, one from the ~~emergency system~~ critical branch and one from the normal system. All branch circuits from the normal system shall originate in the same panelboard. The electrical receptacles or the cover plate for the electrical receptacles supplied from the critical branch shall have a distinctive color or marking so as to be readily identifiable and shall also indicate the panelboard and branch circuit number supplying them.

The Bbranch circuits serving patient bed locations shall not be part of a multiwire branch circuit.

Comments:

The 2014 NEC removed the term *emergency system* from Article 517. Therefore, one of the two branch circuits to supply patient bed locations is now required to be supplied from the critical branch rather than from the emergency system.

The branch circuit serving patient bed locations still cannot be part of a multiwire branch circuit and the normal system branch circuits must continue to originate from the same panelboard.

A new requirement for all receptacles or the cover plate supplied from the critical branch is to have a distinctive color or marking so as to be readily identifiable. These markings are also required to indicate the panelboard and branch circuit number supplying these receptacles. The three existing exceptions for these requirements remain in place.

(B) Patient Bed Location Receptacles

The NEC increased from **four** to **eight** the minimum number of receptacles required for general care area patient bed locations of health care facilities.

NEC Language

(B) Patient Bed Location Receptacles

Each patient bed location shall be provided with a minimum of ~~four~~ eight receptacles.

They shall be permitted to be of the single, duplex, or quadruplex type, or any combination of the three. All receptacles, ~~whether four or more,~~ shall be listed "hospital grade" and shall be so identified. The grounding terminal of each receptacle shall be connected to an insulated copper equipment grounding conductor sized in accordance with Table 250.122.

Exception No. 1: The requirements of 517.18(B) shall not apply to psychiatric, substance abuse, and rehabilitation hospitals meeting the requirements of 517.10(B)(2).

Exception No. 2: Psychiatric security rooms shall not be required to have receptacle outlets installed in the room.

Comments

This change aligns the NEC with *NFPA 99, Health Care Facilities Code*.

The 2012 NFPA 99 underwent some major modification, one of which eliminated all occupancy chapters within the document and adopted a risk-based approach for patients. Also, this introduced a new process detailing building systems categories in healthcare facilities:

Category 1 covers facility systems in which failure of such equipment or system is likely to cause major injury or death of patients or caregivers.

Category 2 is facility systems in which failure of such equipment is likely to cause minor injury to patients or caregivers.

Category 3 is facility systems in which failure of such equipment is not likely to cause injury to patients or caregivers but can cause patient discomfort.

Category 4 is facility systems in which failure of such equipment would have no impact on patient care.

These categories are determined by documenting a defined risk-assessment procedure found in NFPA 99.

517.19 Critical Care Areas

(B) Patient Bed Location Receptacles

(1) Minimum Number and Supply

(2) Receptacle Requirements

The 2014 NEC increased from ~~six~~ to **fourteen** the minimum number of receptacles required for critical care area patient bed locations of health care facilities.

517.19 Critical Care Areas

NEC Language

(B) Patient Bed Location Receptacles

(1) Minimum Number and Supply

Each patient bed location shall be provided with a minimum of ~~six~~ **fourteen** receptacles, at least one of which shall be connected to either of the following:

(1) The normal system branch circuit required in 517.19(A)

(2) ~~An emergency system~~ critical branch circuit supplied by a different transfer switch than the other receptacles at the same patient bed location.

(2) Receptacle Requirements

The receptacles required in 517.19(B)(1) shall be permitted to be single, duplex, or quadruplex type or any combination thereof. All receptacles shall be listed "hospital grade" and shall be so identified. The grounding terminal of each receptacle shall be connected to the reference grounding point by means of an insulated copper equipment grounding conductor.

Comments

NFPA 99 Section 6.3.2.2.6.2 requires each patient bed location in critical care areas, where considered a Category 1 application, to be provided with a minimum of fourteen receptacles. Section 517.19(B) in the 2011 NEC required only six receptacles.

This revision brings 517.19(B) in line with NFPA 99, *Health Care Facilities Code*.

(C) Operating Room Receptacles

(1) Minimum Number and Supply

(2) Receptacle Requirements

The 2014 NEC now requires a minimum number of **36 receptacles** in operating rooms of health care facilities.

NEC Language

517.19 Critical Care Areas

(C) Operating Room Receptacles

Each operating room shall be provided with a minimum of 36 receptacles, at least 12 of which shall be connected to either of the following:

(1) The normal system branch circuit required in 517.19(A)

(2) A critical branch circuit supplied by a different transfer switch than the other receptacles at the same location

(2) Receptacle Requirements

The receptacles required in 517.19(C)

(1) shall be permitted to be of the single or duplex types or a combination of both. All receptacles shall be listed hospital grade and so identified. The grounding terminal of each receptacle shall be connected to the reference grounding point by means of an insulated copper equipment grounding conductor.

Comments

The 2014 NEC now requires a minimum number of thirty-six receptacles in an operating room, with at least twelve of the thirty-six receptacles to be connected to either the normal system branch or the critical branch circuit supplied by a different transfer switch than the other receptacles at the same location.

All of these receptacles can be supplied from a configuration of single, duplex, or quadruplex type, or any combination of the three.

All of these operating room receptacles must be listed *hospital grade-type receptacles* and so identified.

The grounding terminal of each receptacle must also be connected to the reference grounding point by means of an insulated copper equipment grounding conductor.

517.30 Essential Electrical Systems for Hospitals

(B) General

(1) Separate Branches

(2) Emergency Systems

The 2014 NEC eliminated the term *Emergency Systems* from Article 517, leaving only the essential system with the three separate branches: **critical**, **life safety** and **equipment**.

The diagram in Figure 517.30, No. 1 has been re-worked to reflect these changes as well.

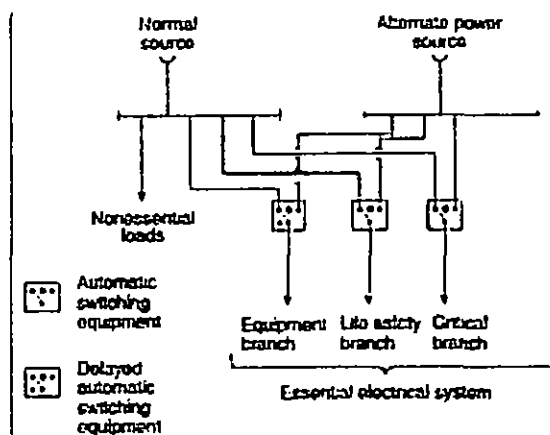

Informational Note Figure 517.30, No. 1 Hospital — Minimum Requirement (greater than 150 kVA) for Transfer Switch Arrangement.

Source: NEC 2014

NEC Language

(B) General

(1) Separate Branches Systems

Essential electrical systems for hospitals shall be comprised of three ~~two~~ separate branches ~~systems~~ capable of supplying a limited amount of lighting and power service that is considered essential for life safety and effective hospital operation during the time the normal electrical service is interrupted for any reason.

These three ~~two~~ branches ~~systems~~ are life safety, critical, and ~~shall be the emergency system and the equipment system.~~

Here is the cleaned-up version:

(1) Separate Branches. Essential electrical systems for hospitals shall be comprised of three separate branches capable of supplying a limited amount of lighting and power service that is considered essential for life safety and effective hospital operation during the time the normal electrical service is interrupted for any reason. The three branches are **life safety**, **critical**, and **equipment**.

~~(2) Emergency Systems.~~ The emergency system shall be limited to circuits essential to life safety and critical patient care.

~~These are designated the life safety branch and the critical branch.~~

~~(3) Equipment System.~~ The equipment system shall supply major electrical equipment necessary for patient care and basic hospital operation.

~~(4) (2) Transfer Switches.~~ The number of transfer switches to be used shall be based on reliability, design, and load considerations.

Each branch of the essential electrical emergency system and each equipment system shall have one or more transfer switches. One transfer switch and downstream distribution system shall be permitted to serve one or more branches or systems in a facility with a maximum demand on the essential electrical system of 150 kVA.

Informational Note No. 1: See NFPA 99-2012 2005, Standard for Health Care Facilities Code, 6.4.3.2 4.4.3.2, Transfer Switches Operation Type I; 6.4.2.1 5 4.4.2.1.4, Automatic Transfer Switch Features; 6.4.2.1.5.15, Nonautomatic Transfer Switch Features, and 6.4.2.1.7 4.4.2.1.6, Nonautomatic Transfer Device Features.

Informational Note No. 2: See Informational Note Figure 517.30, No. 1.

Informational Note No. 3: See Informational Note Figure 517.30, No. 2.

~~(5) (3) Optional Loads~~ (text unchanged)

~~(6) (4) Contiguous Facilities.~~ (text unchanged)

Comments

This change leaves only the essential system with the three separate branches: **critical, life safety and equipment branch.**

(E) Receptacle Identification

The NEC now requires cover plates or the receptacles supplied from the essential electrical system to have a distinctive color or marking, and must also be supplied with an illuminated face or an indicator light to indicate that there is power to the receptacle.

517.30 Essential Electrical Systems for Hospitals

NEC Language

(E) Receptacle Identification

The cover plates for the electrical receptacles or the electrical receptacles themselves supplied from the emergency essential electrical system shall have a distinctive color or making so as to be readily identifiable. [~~99:4.4.2.2.4.2(B)~~ 99:6.4.2.2.6.2(C)]

Nonlocking-type, 125-volt, 15- and 20-ampere receptacles shall have an illuminated face or an indicator light to indicate that there is power to the receptacle.

Comments

The 2012 NEC removed all references to the emergency system from Article 517.

The 2014 NEC now requires these receptacles to be supplied from the essential electrical system.

The cover plates or the electrical receptacles themselves are still required to have a distinctive color or marking so as to be readily identifiable, but they now must also be supplied with an illuminated face or an indicator light to indicate that there is power to the receptacle.

Receptacles that are supplied from the essential electrical system must be clearly identified to insure that vital health care equipment and instrumentation continue to function in the event of power interruption.

The previous language at 517.30(E) required no method of indicating that the receptacles on these essential electrical circuits were, in fact, continually supplying power to the equipment.

(G) Coordination

The NEC now states that overcurrent devices for the essential electrical system do not need to be fully selectively coordinated but only requires "coordination" for fault events that exceed 0.1 seconds.

NEC Language

517.30 Essential Electrical Systems for Hospitals

(G) Coordination

Overcurrent protective devices serving the essential electrical system shall be selectively coordinated for the period of time that a fault's duration extends beyond 0.1 second.

Exception No. 1: Between transformer primary and secondary overcurrent protective devices, where only one overcurrent protective device or set of overcurrent protective devices exist on the transformer secondary.

Exception No. 2: Between over current protective devices of the same size (ampere rating) in series.

Informational Note: The terms "Coordination" and "Coordinated" as used in this section do not cover the full range of overcurrent conditions.

Comments

This is another change that is designed to bring Article 517 in line with *NFPA 99, Health Care Facilities Code*.

This new 517.30(G) permits overcurrent devices installed to achieve selective coordination of the essential electrical system to only operate for episodes longer than 1/10th of a second.

Allowing the circuit protection to function that late in the cycle of an overcurrent event means that only overload conditions will be interrupted by the nearest overcurrent protection device.

ARTICLE 520 Theaters, Audience Areas of Motion Picture and Television Studios, Performance Areas, and Similar Locations

520.1 Scope & 520.2 Definitions

I. General

This article covers all buildings or that part of a building or structure, indoor or outdoor, designed or used for presentation, dramatic, musical, motion picture projection, or similar purposes and to specific audience seating areas within motion picture or television studios.

The 2014 NEC added three new definitions to Article 520 to meet demands of new theatre stage lighting technology.

NEC Language

Stage Equipment

Stage Equipment

Equipment at any location on the premises integral to the stage production including, but not limited to, equipment for lighting, audio, special effects, rigging, motion control, projection, or video.

Stage Lighting Hoist

Stage Lighting Hoist

A motorized lifting device that contains a mounting position for one or more luminaires, with wiring devices for connection of luminaires to branch circuits, and integral flexible cables to allow the luminaires to travel over the lifting range of the hoist while energized.

Stage Switchboard

Stage Switchboard

A switchboard, panelboard, or rack containing dimmers or relays with associated overcurrent protective devices, or overcurrent protective devices alone, used primarily to feed stage equipment.

Comments

Theatre technology is changing and these new definitions help apply the appropriate rules to newer, more advanced stage lighting equipment. This advanced stage lighting equipment has moved from tungsten luminaires fed from dimmers and now can include arc-source or LED luminaires controlled by a data connection directly to the luminaire.

Modern stage lighting switchboards may be a relay cabinet or a panel of circuit breakers used as a dimming system. Stage equipment is no longer simply the stage lighting and controller.

Stage equipment is no longer limited to lighting equipment. Stage switchboards are required to supply a wide variety of production-related equipment, not just lighting equipment.

ARTICLE 547 Agricultural Buildings

547.1 Scope & 547.2 Definitions

The provisions of this article shall apply to the following agricultural buildings or that part of a building or adjacent areas of similar or like nature as specified in 547.1(A) or (B).

(A) Excessive Dust and Dust with Water. Agricultural buildings where excessive dust and dust with water may accumulate, including all areas of poultry, livestock, and fish confinement systems, where litter dust or feed dust, including mineral feed particles, may accumulate.

(B) Corrosive Atmosphere. Agricultural buildings where a corrosive atmosphere exists. Such buildings include areas where the following conditions exist:

- (1) Poultry and animal excrement may cause corrosive vapors.
- (2) Corrosive particles may combine with water.
- (3) The area is damp and wet by reason of periodic washing for cleaning and sanitizing with water and cleansing agents.
- (4) Similar conditions exist.

Equipotential Plane

Equipotential plane for agriculture buildings is to minimize (not prevent) voltage potentials within the plane and between the plane, grounded equipment, and the earth.

NEC Language

547.2 Definitions.

Equipotential Plane

An area where wire mesh or other conductive elements are embedded in or placed under concrete, bonded to all metal structures and fixed nonelectrical equipment that may become energized, and connected to the electrical grounding system to ~~prevent a difference in~~ minimize voltage ~~from developing~~ potentials within the plane and between the plane, grounded equipment, and the earth.

Comments

The 2014 NEC revised the definition of an equipotential plane for agriculture buildings to more closely represent the level of voltage reduction obtained with an equipotential plane.

The equipotential plane never completely eliminates all of the voltage granulates or stray voltage that could be present between the earth, grounded metal equipment, and a concrete floor of something like a dairy barn.

Stray voltage is a difference in voltage potential between two metal objects.

These voltages are termed "stray voltage" when they can be measured between two metal objects that are contacted simultaneously by livestock or people. If this voltage reaches sufficient levels, animals coming into contact with grounded devices may receive a mild electrical shock.

547.5 Wiring Methods

(F) Separate Equipment Grounding Conductor

The NEC now permits an insulated or covered aluminum or copper equipment grounding conductor for underground agricultural building installations.

NEC Language

(F) Separate Equipment Grounding Conductor

Where an equipment grounding conductor is installed underground within a location falling under the scope of Article 547, it shall be a copper conductor. ~~Where an equipment grounding conductor is installed underground, it shall be insulated or covered copper.~~

Comments

The NEC now permits the use of an aluminum equipment grounding conductor as well as copper for underground installations at agricultural buildings or structures falling under the scope of Article 547.

Previous language only permitted a copper equipment grounding conductor due to *considerations regarding corrosion and oxidation, and exposure to the many contaminants* present in and around livestock facilities. While all metals corrode, aluminum is highly corrosion-resistant.

Aluminum conductors are used in many agricultural applications, including power conductors, irrigation pipe, watering troughs, fencing, etc. These conductors have a proven track record of being suitable for agricultural applications.

Please note that 250.120(B) requires that aluminum conductors must not be terminated within 450 mm (18 in.) of the earth.

ARTICLE 550 Mobile Homes, Manufactured Homes, and Mobile Home Parks

550.1 Scope & 550.15 Wiring Methods and Materials

550.1 Scope

I. General

The provisions of this article cover the electrical conductors and equipment installed within or on mobile and manufactured homes, the conductors that connect mobile and manufactured homes to a supply of electricity, and the installation of electrical wiring, luminaires, equipment, and *appurtenances related to electrical installations within a mobile home park up to the mobile home service entrance conductors or, if none, the mobile home service equipment.*

Informational Note: For additional information on manufactured housing see NFPA 501-2013, Standard on Manufactured Housing, and Part 3280, Manufactured Home Construction and Safety Standards, of the Federal Department of Housing and Urban Development.

550.15 Wiring Methods and Materials

(H) Under-Chassis Wiring (Exposed to Weather)

The NEC revised this section to allow any raceway or conduit "approved" for a wet location or where subject to physical damage.

NEC Language

550.15 Wiring Methods and Materials

Except as specifically limited in this section, the wiring methods and materials included in this Code shall be used in mobile homes. Aluminum conductors, aluminum alloy conductors, and aluminum core conductors such as copper-clad aluminum shall not be acceptable for use as branch-circuit wiring.

(H) Under-Chassis Wiring (Exposed to Weather)

Where outdoor or under chassis line voltage (120 volts, nominal, or higher) wiring is exposed to moisture or physical damage, it shall be protected by ~~rigid metal conduit or intermediate metal conduit, except as provided in (1) or (2)~~ a conduit or raceway approved for use in wet locations or where subject to physical damage. The conductors shall be ~~suitable~~ listed for use in wet locations.

~~(1) Where closely routed against frames and equipment enclosures, reinforced thermosetting resin conduit (RTRC) listed for aboveground use, Type MI cable, electrical metallic tubing, or rigid polyvinyl chloride conduit (PVC) shall be permitted.~~

~~(2) Where extending vertically from a direct burial depth of at least 457 mm (18 in.) below grade and terminated to a factory-installed conduit or enclosure, Schedule 80 PVC or RTRC listed for exposure to physical damage.~~

Comments

The 2014 NEC revised 550.15(H) to permit mobile home line-voltage wiring (120 volts, nominal, or higher) installed outdoors or under the chassis of the mobile home, exposed to moisture or physical damage, to be protected by a conduit or raceway "approved" for use in wet locations or where subject to physical damage.

Rather than the conductors having to be "suitable" for use in a wet location, the conductors must now be "listed" for use in wet locations.

ARTICLE 551 Recreational Vehicles and Recreational Vehicle Parks

551.1 Scope & 551.4 General Requirements

551.1 Scope

I. General

The provisions of this article cover the electrical conductors and equipment other than low-voltage and automotive vehicle circuits or extensions thereof, installed within or on recreational vehicles, the conductors that connect recreational vehicles to a supply of electricity, and the installation of equipment and devices related to electrical installations within a recreational vehicle park.

Informational Note: For information on low-voltage systems, refer to NFPA 1192-2011, Standard on Recreational Vehicles, and ANSI/RVIA 12V-2011, Standard for Low Voltage Systems in Conversion and Recreational Vehicles.

551.4 General Requirements

(C) Labels

The NEC added a new subsection to standardize label requirements in Article 551 at one location.

NEC Language

551.4 General Requirements

(C) Labels

Labels required by Article 551 shall be made of etched, metal-stamped, or embossed brass; stainless steel; plastic laminates not less than 0.13 mm (0.005 in.) thick; or anodized or alclad aluminum not less than 0.5 mm (0.020 in.) thick or the equivalent.

Informational Note: For guidance on other label criteria used in the recreational vehicle industry, refer to 2011 ANSI Z535, Product Safety Signs and Labels.

Comments

These new provisions will enable the RV industry to provide a set of RV labels that will be uniform and more recognizable for the RV consumer.

551.71 Type Receptacles Provided. (Recreational Vehicle Parks)

Type Receptacles Provided

The NEC now requires every recreational vehicle site equipped with a 50-ampere receptacle to also be equipped with a 30-ampere, 125-volt receptacle.

NEC Language

551.71 Type Receptacles Provided. (Recreational Vehicle Parks)

Type Receptacles Provided

Every recreational vehicle site with electrical supply shall be equipped with at least one 20-ampere, 125-volt receptacle.

A minimum of 20 percent of all recreational vehicle sites, with electrical supply, shall each be equipped with a 50-ampere, 125/250-volt receptacle conforming to the configuration as identified in Figure 551.46(C).

Every recreational vehicle site equipped with a 50-ampere receptacle shall also be equipped with a 30-ampere, 125-volt receptacle conforming to Figure 551.46(C).

(The remainder of the text is unchanged.)

Comments

Recreational vehicles increasingly come with a 30-ampere, 125-volt, 2-pole, 3-wire electrical supply cord.

At RV sites with only a 50-ampere receptacle, a 50-ampere to 30-ampere "cheater" cord is being sold to connect a 30-ampere RV supply cord to a 50-ampere receptacle.

Proper connection of the grounding and bonding connections is only one concern with these "cheater" cords.

ARTICLE 555 Marinas and Boatyards

555.1 Scope & 555.15 Grounding

555.1 Scope

This article covers the installation of wiring and equipment in the areas comprising fixed or floating piers, wharves, docks, and other areas in marinas, boatyards, boat basins, boathouses, yacht clubs, boat condominiums, docking facilities associated with residential condominiums, any multiple docking facility, or similar occupancies, and facilities that are used, or intended for use, for the purpose of repair, berthing, launching, storage, or fueling of small craft and the moorage of floating buildings.

Private, noncommercial docking facilities constructed or occupied for the use of the owner or residents of the associated single-family dwelling are not covered by this article.

Informational Note: See NFPA 303-2011, Fire Protection Standard for Marinas and Boatyards, for additional information.

555.15 Grounding

(B) Type of Equipment Grounding Conductor

(C) Size of Equipment Grounding Conductor

The 2014 NEC now permits the use of an insulated aluminum or copper equipment grounding conductor at marinas and boatyards.

NEC Language

Wiring and equipment within the scope of this article shall be grounded as specified in Article 250 and as required by 555.15(A) through (E).

(B) Type of Equipment Grounding Conductor

The equipment grounding conductor shall be an insulated ~~copper~~ conductor with a continuous outer finish that is either green or green with one or more yellow stripes. The equipment grounding conductor of Type MI cable shall be permitted to be identified at terminations.

For conductors larger than 6 AWG, or where multiconductor cables are used, re-identification of conductors as allowed in 250.119(A)(2)(b) and (A)(2)(c) or 250.119(B)(2) and (B)(3) shall be permitted.

(C) Size of Equipment Grounding Conductor

The insulated ~~copper~~ equipment grounding conductor shall be sized in accordance with 250.122 but not smaller than 12 AWG.

Comments

The NEC now recognizes that limiting equipment grounding conductors used in marina and boatyard wiring systems to only copper is not justifiable.

Aluminum conductors are well-suited for the application and commonly available.

Many of the terminations used at marinas and boatyards are primarily aluminum and are, in all likelihood, better suited for use with aluminum conductors in these locations.

Aluminum ungrounded and grounded neutral conductors have been used satisfactorily for decades in marina and boatyard installations.

Additionally, when properly insulated, aluminum has been proven to be highly resistant to corrosion in marinas and boatyards.

ARTICLE 590 Temporary Installations

590.1 Scope & 590.4 General

590.1 Scope

The provisions of this article apply to temporary electric power and lighting installations.

590.4 General

(D) Receptacles

(2) Receptacles in Wet Locations

The NEC now requires "Extra duty" covers for all 15- and 20-ampere, 125- and 250-volt receptacles installed at temporary installations in a wet location (not just those supported from grade).

This requirement now also includes dwelling unit temporary installation wet location receptacles as well.

NEC Language

(D) Receptacles

(2) Receptacles in Wet Locations

All 15- and 20-ampere, 125- and 250-volt receptacles installed in a wet location shall comply with 406.9(B)(1).

[See revisions at 406.9(B)(1) for changes for "Extra Duty" covers]

Comments

The 2014 NEC now requires all enclosures and covers installed in wet locations for 15- and 20-ampere, 125- and 250-volt receptacles to be listed and be of the "extra duty" type, not just boxes supported from grade. This requirement is now also required at dwelling units.

All 15- and 20-ampere, 125- and 250-volt receptacles installed in a wet location must still have an enclosure and cover that are weatherproof whether an attachment plug cap is inserted or not.

The requirement for weather-resistant type receptacles in wet locations is still applicable.

(I) Termination(s) at Devices

Flexible cords and cables must now be secured to boxes with fittings "*listed for connecting flexible cords and cables to boxes.*"

NEC Language

(I) Termination(s) at Devices

Flexible cords and cables entering enclosures containing devices requiring termination shall be secured to the box with fittings listed for connecting flexible cords and cables to boxes ~~designed for the purpose.~~

Comments

Flexible cords and cables entering enclosures containing devices requiring termination are now required to be secured to the box with fittings "*listed for connecting flexible cords and cables to boxes.*"

(J) Support

Cable assemblies and flexible cords installed as branch circuits or feeders are now prohibited from being installed or laid on the floor or the ground for temporary installations such as construction sites.

(This does not include extension cords.)

NEC Language

(J) Support

Cable assemblies and flexible cords and cables shall be supported in place at intervals that ensure that they will be protected from physical damage. Support shall be in the form of staples, cable ties, straps, or similar type fittings installed so as not to cause damage.

Cable assemblies and flexible cords and cables installed as branch circuits or feeders shall not be installed on the floor or on the ground.

Extension cords shall not be required to comply with 590.4(J).

Vegetation shall not be used for support of overhead spans of branch circuits or feeders.

Comments

On many occasions, temporary wiring at construction sites is run on the floor and on the ground.

In some cases, the wiring method enlisted for this temporary wiring is nonmetallic-sheathed cable (Type NM cable). This can be a dangerous practice.

It is also not uncommon to see these cable assemblies laying on the ground or concrete floor and damaged by normal construction activity.

Construction site locations can quickly become a wet location, particularly during the time of construction when the complete roof and windows are not installed.

The rules and regulations at 590.6 for GFCI protection provide excellent safeguards for workers utilizing cord- and plug-connected tools, but this GFCI protection is only in effect on the load side of the temporary receptacle outlet. There is no GFCI protection on the feeder or branch circuit supplying these receptacle outlets.

The OSHA standards for construction do not allow these feeders or branch circuits to be run on the floor or ground [see 1926.405(a)(2)(ii)(b)]. This new requirement would not impact the normal construction site use of extension cords that are normally connected and disconnected to a construction site branch circuit. Extension cord use would still be subject to protection from physical damage during its transient use.

Conclusion

2014 NEC Changes - Chapter 5: Special Occupancies

Summary

You have completed Chapter 5 of this course on *Changes in the 2014 NEC*.

Resources

References

NFPA. *2014 National Electrical Code (NEC)*, 2013.

International Association of Electrical Inspectors, Richardson, Texas and National Fire Protection Association, Inc. Quincy, MA. *Analysis of Changes – NEC 2014*, 2013.

The designations "National Electrical Code" and "NEC" refer to NFPA 70, National Electrical Code, which is a registered trademark of the National Fire Protection Association.

Author Biography

Neal L. Burdick

Neal Burdick has over 30 years of experience and is currently a construction inspector for the City of Tampa. He is a registered instructor for the Electrical Council of Florida and is the author and instructor of a State of Florida approved Electrical Contractor's Licensing Board course.

Neal is an accomplished and exceptionally knowledgeable professional with a solid background in electrical and building inspections, as well as code compliance. He is recognized as an expert in this industry. He is an active member of IAEI, BOAF, ECF, and related industry associations. Mr. Burdick conducts training to building officials, engineers, plans examiners, inspectors, electrical contractors, and apprentices throughout the State of Florida.



2014 NEC Changes - Chapter 6: Electric Signs and Outline Lighting

Table of Contents

Introduction	4
Course Overview	4
Learning Objectives	4
ARTICLE 600 - Electric Signs and Outline Lighting	5
600.1 Scope & 600.4 Markings	5
600.6 Disconnects	6
600.7 Grounding and Bonding	7
ARTICLE 610 Cranes and Hoists	8
610.1 Scope & 610.31 Runway Conductor Disconnecting Means. (<i>Cranes and Hoists</i>)	8
ARTICLE 620 Elevators, Dumbwaiters, Escalators, Moving Walks, Platform Lifts, and Stairway Chairlifts	9
620.1 Scope & 620.21 Wiring Methods (Elevators, Escalators, Etc.)	9
620.51 Disconnecting Means	10
ARTICLE 625 Electric Vehicle Charging System	12
625.1 Scope	12
ARTICLE 630 Electric Welders	14
630.1 Scope & 630.13 Disconnecting Means	14
ARTICLE 645 Information Technology Equipment	15
645.1, 645.14, 645.15	15
645.27 Selective Coordination	16
ARTICLE 646 Modular Data Centers	17
646.1 Scope	17
ARTICLE 680 Swimming Pools, Fountains, and Similar Installations	18
680.1 Scope & 680.2 Definitions	18
680.12 Maintenance Disconnecting Means	19
680.21 Motors	20
680.22 Lighting, Receptacles, and Equipment	20
680.25 Feeders	23
680.26 Equipotential Bonding	24
680.42 Outdoor Installations	25
680.57 Signs	26
ARTICLE 690 Solar Photovoltaic (PV) Systems	27

2014 NEC Changes - Chapter 6: Electric Signs and Outline Lighting

690.1 Scope & 690.2 Definitions.....	27
690.5 Ground-Fault Protection.....	29
690.7 Maximum Voltage.....	31
690.9 Overcurrent Protection.....	32
690.10 Stand-Alone Systems.....	33
690.12 Rapid Shutdown of PV Systems on Buildings.....	33
690.31 Methods Permitted.....	34
690.35 Ungrounded Photovoltaic Power Systems.....	35
690.41 System Grounding.....	36
690.47 Grounding Electrode System.....	37
690.81 Listing.....	39
Article 694 Wind Electric Systems.....	40
694.1 Scope.....	40
Conclusion.....	42
Summary.....	42
Resources.....	43
References.....	43
Author Biography.....	44
Neal L. Burdick.....	44

Introduction

Course Overview

This is the **sixth** of several courses covering the changes in the 2014 edition of the **National Electrical Code** (NEC) created by the NFPA. The 2014 NEC provides an accurate, reliable, and authoritative account of the hundreds of significant revisions in the 2014 Code.

This course provides coverage of significant changes in the *2014 National Electrical Code*. With every new edition of the NEC, some of the changes include new requirements to sections, while some of the changes include entirely new articles. Some changes are revisions to existing requirements while others are deletions to some existing requirements.

Although not required, **it is recommended to have a copy of the 2014 NEC manual for reference**, especially when reviewing information in large tables.

A **Summary of each change** is followed by the actual NEC Language, with deletions showing with a ~~strikethrough~~ and additions/changes (highlighted in yellow). When necessary, **Comments** are added to appropriate topics.

In many cases, paragraphs not directly affected by a change are retained to preserve context. *There will be no quiz questions on material that does not cover changes in the 2014 NEC.*

The length of each segment varies depending on the topic and material available.

The National Electrical Code is intended for electricians and subcontractors, electrical inspectors, electrical engineers, designers, and other qualified persons who understand electrical currents, theory, safety procedures, and electrical trade practices. The code does not serve as a teaching manual for untrained individuals.

Chapter 6, which covers electric signs and outline lighting, is the second of three NEC chapters that deal with special topics.

Special Equipment is equipment that, by the nature of its use, construction, or by its unique nature, creates a need for additional measures to ensure the mission of the NEC "Safeguarding of people and property."

Learning Objectives

By the end of this course, you will be able to:

- Identify the various significant changes in Chapter 6 of the NEC
- Recognize that the NEC contains provisions that are considered necessary for safety; compliance therewith and proper maintenance results in an installation that is essentially free from hazard
- Refer to the appropriate sections of the code and find applicable changes
- Explain the reason for the new disconnection of wiring requirements for poles or signs that helps protect workers
- Identify the new safety requirements for pool pump motors and GFCI devices
- Describe the characteristics for ground-fault circuit-interrupter protection for personnel
- List the five requirements for safe rapid shutdown of PV systems on buildings
- Explain the safety purpose of PV grounding electrode systems

ARTICLE 600 - Electric Signs and Outline Lighting

600.1 Scope & 600.4 Markings

This article covers the installation of conductors, equipment, and field wiring for electric signs and outline lighting, regardless of voltage. All installations and equipment using neon tubing, such as signs, decorative elements, skeleton tubing, or art forms, are covered by this article.

Informational Note: Sign and outline lighting illumination systems include, but are not limited to, cold cathode neon tubing, high-intensity discharge lamps (HID), fluorescent or incandescent lamps, light-emitting diodes (LEDs), and electroluminescent and inductance lighting.

Changed From NEC 2011

600.4 Markings

(E) Installation Instructions

The 2014 NEC now requires all signs, outline lighting, skeleton tubing systems and retrofit kits to be marked to indicate that field-wiring and installation instructions are required (not just section signs).

NEC Language

600.4 Markings

(E) ~~Section Signs~~ Installation Instructions

~~Section~~ All signs, outline lighting, skeleton tubing systems and retrofit kits shall be marked to indicate that field wiring and installation instructions are required.

Exception: Portable, cord connected signs are not required to be marked.

Comments

The 2014 NEC added an exception that excludes portable, cord-connected signs from this marking requirement.

The previous wording at this subsection only applied to section signs.

Section 110.3(B) requires listed or labeled equipment to be installed and used in accordance with manufacturer's instructions included in the listing or labeling.

Listing and labeling of equipment serves as the primary basis for approvals by the *authority having jurisdiction (AHJ)*. Without indication from the manufacturer, it can be difficult, particularly for the AHJ to know precisely when field-wiring is necessary and when a sign component is part of a packaged assembly.

The *UL Guide Information for Electrical Equipment (White Book)*, under category UXYT for signs, clearly indicates, "...the acceptability of the assembled sections in the field rests with the authority having jurisdiction." To carry out the approval process, AHJs should verify that the installed listed sign component is installed in accordance with its associated installation instructions.

This revision now requires manufacturers of listed sign components to provide installation instructions for the field installer.

This revision establishes continuity between requirements in 600.3 and listing requirements for signs and *UL 48, Electric Signs*, the product standard for electric signs.

600.6 Disconnects

Each sign and outline lighting system, feeder circuit or branch circuit supplying a sign, outline lighting system, or skeleton tubing shall be controlled by an externally operable switch or circuit breaker that opens all ungrounded conductors and controls no other load. The switch or circuit breaker shall open all ungrounded conductors simultaneously on multi-wire branch circuits in accordance with 210.4(B). Signs and outline lighting systems located within fountains shall have the disconnect located in accordance with 680.12.

Exception No. 1: A disconnecting means shall not be required for an exit directional sign located within a building.

Exception No. 2: A disconnecting means shall not be required for cord-connected signs with an attachment plug.

(A) Location.

(1) At Point of Entry to a Sign Enclosure

The 2014 NEC now requires the disconnect to be located at the point feeder(s) or branch circuit(s) supplying a sign or where an outline lighting system enters a sign enclosure or pole.

This new language requires disconnection of all wiring where it enters the enclosure of the sign or pole.

NEC Language

600.6 Disconnects

Each sign and outline lighting system, feeder circuit or branch circuit supplying a sign, outline lighting system, or skeleton tubing shall be controlled by an externally operable switch or circuit breaker that opens all ungrounded conductors and controls no other load. The switch or circuit breaker shall open all ungrounded conductors simultaneously on multi-wire branch circuits in accordance with 210.4(B).

(Please see your copy of the NEC for the remainder of the text)

(A) Location.

(1) At Point of Entry to a Sign Enclosure

The disconnect shall be located at the point the feeder circuit or branch circuit(s) supplying a sign or outline lighting system enters a sign enclosure or a pole in accordance with 600.5(C)(3) and shall disconnect all wiring where it enters the enclosure of the sign or pole.

Exception: A disconnect shall not be required for branch or feeder circuits passing through the sign where enclosed in a Chapter 3 listed raceway.

Comments

Section 600.6 requires each sign and outline lighting system, feeder circuit or branch circuit supplying a sign, outline lighting system, or skeleton tubing to be controlled by an externally operable switch or circuit breaker that opens all ungrounded conductors.

Without the provisions of this new requirement, exposed, insulated supply conductors to these disconnecting means can be installed within the sign enclosure, cabinets, poles, etc., to the supply side of the randomly located disconnect and remain energized, with the supplied disconnecting means in the open or closed position.

This new disconnection of all wiring where it enters the enclosure of the sign or pole requirement helps protect workers by removing live conductors present after the disconnect switch has been de-energized.

The exception to this new rule allows a branch circuit or feeder to pass through a sign where enclosed in a NEC Chapter 3 listed raceway, allowing the disconnecting means at each section of a large sign. This allows an extremely large sign with an extremely large structure provided with multiple feeders, branch circuits with perhaps multiple 200-ampere panel boards provided at each level of the sign structure, to qualify as the required disconnecting means.

The circuit breaker(s) in each of these panel boards will act as the disconnecting means before the circuits enter each sign section or enclosure.

600.7 Grounding and Bonding

(A) Grounding

(1) Equipment Grounding

The NEC now requires metal parts of skeleton tubing, signs and outline lighting systems to be grounded by connection to the equipment grounding conductor of the supply branch circuit(s) or feeder.

NEC Language

600.7 Grounding and Bonding

(A) Grounding

(1) Equipment Grounding

Signs and Metal Equipment of signs, outline lighting, and skeleton tubing systems shall be grounded by connection to the equipment grounding conductor of the supply branch circuit(s) or feeder using the types of equipment grounding conductors specified in 250.118.

Exception: Portable cord-connected signs shall not be required to be connected to the equipment grounding conductor where protected by a system of double insulation or its equivalent. Double insulated equipment shall be distinctively marked.

Comments

The NEC defines skeleton tubing at 600.2 as "*neon tubing that is itself the sign or outline lighting and not attached to an enclosure or sign body.*"

Skeleton neon tubing systems operate at voltages over 1000 volts and are field assembled similar to section signs with neon illumination.

Remote non-current carrying metal parts, such as through-wall neon tubing receptacles, transformer enclosures, and metallic raceways used for secondary conductors have the potential to be energized. These metal parts need to be properly bonded to the equipment grounding conductor of the supply branch circuit(s) or feeder for electrical continuity and safety the same as metal parts of section signs and outline lighting systems.

ARTICLE 610 Cranes and Hoists

610.1 Scope & 610.31 Runway Conductor Disconnecting Means. (*Cranes and Hoists*)

This article covers the installation of electrical equipment and wiring used in connection with cranes, monorail hoists, hoists, and all runways.

Informational Note: For further information, see ANSI B30, Safety Code for Cranes, Derricks, Hoists, Jacks, and Slings.

610.31 Runway Conductor Disconnecting Means. (*Cranes and Hoists*)

A new reference to 430.109, *Types of Disconnecting Means*, replaces the previous incomplete laundry list of types of disconnecting means.

NEC Language

610.31 Runway Conductor Disconnecting Means. (*Cranes and Hoists*)

A disconnecting means that has a continuous ampere rating not less than that calculated in 610.14(E) and (F) shall be provided between the runway contact conductors and the power supply. The disconnecting means shall comply with 430.109. ~~Such disconnecting means shall~~

~~consist of a motor circuit switch, circuit breaker, or molded case switch.~~ This disconnecting means shall be as follows:

- (1) Readily accessible and operable from the ground or floor level
- (2) Lockable in accordance with 110.25. ~~Capable of being locked in the open position. The provision for locking or adding a lock to the disconnecting means shall be installed on or at the switch or circuit breaker used as the disconnecting means and shall remain in place with or without the lock installed. Portable means for adding a lock to the switch or circuit breaker shall not be permitted as the means required to be installed at and remain with the equipment.~~
- (3) Open all ungrounded conductors simultaneously
- (4) Placed within view of the runway contact conductors

Exception: The runway conductor disconnecting means or electrolytic cell lines shall be permitted to be placed out of view of the runway contact conductors where either of the following conditions are met:

- (a) Where a location in view of the contact conductors is impracticable or introduces additional or increased hazards to persons or property
- (b) In industrial installations, with written safety procedures, where conditions of maintenance and supervision ensure that only qualified persons service the equipment

Comments

The 2014 NEC revised this section by removing the incomplete laundry list of types of disconnecting means permitted for cranes and hoists and replacing it with a new reference to 430.109, *Types of Disconnecting Means*.

The lockable provisions for the disconnecting means were replaced with a reference to the new lockable provisions at 110.25.

The NEC also added a new exception for the "*within view of the runway contact conductors*" provision to allow the disconnecting means to be placed out of view of the runway contact conductors under specific conditions.

ARTICLE 620 Elevators, Dumbwaiters, Escalators, Moving Walks, Platform Lifts, and Stairway Chairlifts

620.1 Scope & 620.21 Wiring Methods (Elevators, Escalators, Etc.)

This article covers the installation of electrical equipment and wiring used in connection with elevators, dumbwaiters, escalators, moving walks, platform lifts, and stairway chairlifts.

Informational Note No. 1: For further information, see ASME A17.1-2010/CSA B44-10, Safety Code for Elevators and Escalators.

Informational Note No. 2: For further information, see CSA B44.1-11/ASME-A17.5-2011, Elevator and Escalator Electrical Equipment Certification Standard.

Informational Note No. 3: The term wheelchair lift has been changed to platform lift. For further information, see ASME A18.1-2008, Safety Standard for Platform Lifts and Stairway Lifts.

620.21 Wiring Methods (Elevators, Escalators, Etc.)

Exception

The NEC no longer requires the cords and cables of listed cord- and plug-connected equipment to be installed in a raceway in hoistways, escalators, moving walk-ways, etc.

NEC Language

620.21 Wiring Methods (Elevators, Escalators, etc.)

Conductors and optical fibers located in hoistways, in escalator and moving walk wellways, in platform lifts, stairway chairlift runways, machinery spaces, control spaces, in or on cars, in machine rooms and control rooms, not including the traveling cables connecting the car or counterweight and hoistway wiring, shall be installed in rigid metal conduit, intermediate metal conduit, electrical metallic tubing, rigid nonmetallic conduit, or wireways, or shall be Type MC, MI, or AC cable unless otherwise permitted in 620.21(A) through (C).

Exception: Cords and cables of listed cord- and plug-connected equipment shall not be required to be installed in a raceway.

Comments

The NEC generally requires all conductors and optical fiber cables associated with wiring methods for elevators, escalators, etc., to be installed in some form of a raceway system.

In many cases, listed cord- and plug-connected equipment is used within these installations, such as computer displays, power supplies, etc. The wiring methods typically employed for this type of equipment consists of flexible cords and cables not intended by the manufacturer to be run in a raceway.

Listed cord- and plug-connected equipment is intended and should be allowed to be run without a raceway.

620.51 Disconnecting Means

(C) Location

(1) On Elevators Without Generator Field Control

The 2014 NEC now allows both fused and non-fused motor circuit switches when motor controllers are installed within the elevator hoistway and are not supplied with a means for protection from internal short circuits.

NEC Language

620.51 Disconnecting Means

A single means for disconnecting all ungrounded main power supply conductors for each unit shall be provided and be designed so that no pole can be operated independently.

(Please see your copy of the NEC for the complete text).

(C) Location

The disconnecting means shall be located where it is readily accessible to qualified persons.

(1) On Elevators Without Generator Field Control

On elevators without generator field control, the disconnecting means shall be located within sight of the motor field controller. Where the motor controller is located in the elevator hoistway, the disconnecting means required by 620.51(A) shall be located in a machinery space, machine room, control space or control room outside the hoistway; and an additional, fused or non-fused externally operable motor circuit switch that is lockable in accordance with 110.25 ~~capable of being locked in the open position~~ to disconnect all ungrounded main power-supply conductors shall be located within sight of the motor controller. The additional switch shall be a listed device and shall comply with 620.91(C).

For easier review, here is the cleaned up version of the above paragraph:

(1) On Elevators Without Generator Field Control. On elevators without generator field control, the disconnecting means shall be located within sight of the motor field controller. Where the motor controller is located in the elevator hoistway, the disconnecting means required by 620.51(A) shall be located in a machinery space, machine room, control space, or control room outside the hoistway; and an additional fused or non-fused, enclosed, externally operable motor-circuit switch that is lockable open in accordance with 110.25 to disconnect all ungrounded main power supply conductors shall be located within sight of the motor controller. The additional switch shall be a listed device and shall comply with 620.91(C).

(Please see your copy of the NEC for the remainder of the text).

Comments

On elevators without generator field control, the NEC requires disconnecting means to be located within sight of the motor controller.

Where the motor controller is located in the elevator hoistway, the disconnecting means is also required to be located in a machinery space, machine room, control space or control room outside the hoistway.

In addition to these requirements, a non-fused, enclosed externally, operable motor-circuit switch, capable of being locked in the open position, to disconnect all ungrounded main power-supply conductors was required to be located within sight of the motor controller.

In conjunction with the above provisions that were carried forward from the 2011 NEC, the enclosed externally operable motor-circuit switch for disconnection of all ungrounded main power-supply conductors is now permitted to be either a fused or non-fused motor-circuit switch.

The NEC also added a reference to new 110.25 in Article 110 to provide consistent requirements at one location for "*Lockable Disconnecting Means*" rules. This is one of several locations in the NEC where a reference to 110.25 replaces separate rules for lockable disconnecting means rules. These separate and individual lockable disconnecting means rules varied widely in their uniformity.

ARTICLE 625 Electric Vehicle Charging System

625.1 Scope

The provisions of this article cover the electrical conductors and equipment external to an electric vehicle that connect an electric vehicle to a supply of electricity by conductive or inductive means, and the installation of equipment and devices related to electric vehicle charging.

Informational Note No. 1: For industrial trucks, see NFPA 505-2011, Fire Safety Standard for Powered Industrial Trucks Including Type Designations, Areas of Use, Conversions, Maintenance, and Operation.

Informational Note No. 2: UL 2594-2013, Standard for Electric Vehicle Supply Equipment, is a safety standard for electric vehicle supply equipment. UL 2202-2009, Standard for Electric Vehicle Charging System Equipment, is a safety standard for electric vehicle charging equipment.

Article 625 Electric Vehicle Charging System

The 2014 NEC renumbered and reorganized Article 625 to provide a logical sequence and arrangement.

NEC Language

Article 625 Electric Vehicle Charging System

I. General

625.1 Scope

625.2 Definitions

625.4 Voltages

625.5 Listed or Labeled

II. Equipment Construction ~~Wiring Methods~~

625.10 Electric Vehicle Coupler [Was 625.9]

III. Equipment Construction

~~625.13 Electric Vehicle Supply Equipment~~ [Now 625.44(B)]

~~625.14 Rating~~ [Now 625.41]

625.15 Marking

625.16 Means of Coupling

625.17 Cords and Cables

625.18 Interlock

625.19 Automatic De-Energization of Cable

IV. Control and Protection

~~625.21 Overcurrent Protection~~ [Now 625.40]

625.22 Personnel Protection System.

~~625.28 Hazardous (Classified) Locations.~~

~~625.29 Indoor Sites~~

~~625.30 Outdoor Sites~~

III. Installation

625.40 Overcurrent Protection [Was 625.21]

625.41 Rating [Was 625.14]

625.42 Disconnecting Means [Was 625.23]

625.44 Electric Vehicle Supply Equipment Connection

625.46 Loss of Primary Source [Was 625.25]

625.48 Interactive Systems [Was 625.26]

V. Electric Vehicle Supply Equipment Locations

625.50 Location [Was 625.29(A) and (B) and 625.30(A)(and (B)]

625.52 Ventilation [Was 625.29(C) and (D)]

Comments

Article 625, Electric Vehicle Charging Systems, was arranged with five parts:

Part I. General

Part II. Wiring Methods

Part III. Equipment Construction

Part IV. Control and Protection; and

Part V. Electric Vehicle Supply Equipment Locations.

The 2014 NEC renumbered and reorganized Article 625 into three parts:

Part I. General;

Part II. Equipment Construction; and

Part III. Installation.

This change provides a more logical structure and arrangement.

The titles for the various parts of Article 625 did not fit the requirements within those parts and needed to be revised in order to enhance the comprehensiveness of this EV charging station article.

Article 625 had installation requirements scattered throughout the article, even under parts that are found in the construction parts. New definitions are now located at 625.2.

Clarification of cord- and plug-connected supply equipment is now at 625.44.

Revisions occurred for specific criteria for cords and cables at 625.17.

An EV charging station is an element in an infrastructure that supplies electric energy for the recharging of plug-in electric vehicles, including all-electric cars, neighborhood electric vehicles and plug-in hybrids.

As plug-in hybrid electric vehicles and battery/electric vehicle ownership is expanding, there is a growing need for widely distributed publicly accessible charging stations, some of which support faster charging at higher voltages and currents than are available from domestic supplies.

As of March 2013, the United States had approximately 5,678 charging stations across the country, with over 16,200 public charging points. Of these public charging points, 26 percent are located in California, with 10 percent located in Texas, and 7.4 percent in Washington state.

ARTICLE 630 Electric Welders

630.1 Scope & 630.13 Disconnecting Means

This article covers apparatus for electric arc welding, resistance welding, plasma cutting, and other similar welding and cutting process equipment that is connected to an electrical supply system.

630.13 Disconnecting Means

The 2014 NEC now requires the arc welder disconnect be marked to "*identify*" what the disconnect actually disconnects rather than requiring the disconnect be "*identified*."

NEC Language

630.13 Disconnecting Means (*Electric Welders*)

An identified disconnecting means shall be provided in the supply circuit for each arc welder that is not equipped with a disconnect mounted as an integral part of the welder.

The disconnecting means identity shall be marked in accordance with 110.22(A). The disconnecting means shall be a switch or circuit breaker, and its rating shall be not less than that necessary to accommodate overcurrent protection as specified under 630.12.

Comments

The 2014 NEC still requires a disconnecting means in the supply circuit for each arc welder that is not equipped with a disconnect mounted as an integral part of the welder, but added language to specify that this disconnecting means is required to be marked to "*indicate its purpose*" or "*identify*" what it supplies.

ARTICLE 645 Information Technology Equipment

645.1, 645.14, 645.15

Informational Note: Text that is followed by a reference in brackets has been extracted from NFPA 75-2013, Standard for the Protection of Information Technology Equipment. Only editorial changes were made to the extracted text to make it consistent with this Code.

This article covers equipment, power-supply wiring, equipment interconnecting wiring, and grounding of information technology equipment and systems in an information technology equipment room.

Informational Note: For further information, see NFPA 75-2013, Standard for the Protection of Information Technology Equipment, which covers the requirements for the protection of information technology equipment and information technology equipment areas.

645.14 System Grounding. (Information Technology Equipment)

645.15 Equipment Grounding and Bonding

With this revision, the 2014 NEC divides the grounding requirements for information technology equipment into two separate sections:

1. One for equipment grounding and bonding, and
2. New provisions for systems grounding.

NEC Language

645.14 System Grounding. (*Information Technology Equipment*)

Separately derived power systems shall be installed in accordance with Part I and II of Article 250. Power systems derived within listed information technology equipment that supply information technology systems through receptacles or cable assemblies supplied as part of this equipment shall not be considered separately derived for the purpose of applying 250.30.

645.15 Equipment Grounding and Bonding

All exposed non-current-carrying metal parts of an information technology system shall be bonded to the equipment grounding conductor in accordance with Parts I, V, VI, VII, and VIII of Article 250 or shall be double insulated. ~~Power systems derived within listed information technology equipment that supply information technology systems through receptacles or cable assemblies supplied as part of this equipment shall not be considered separately derived for the purpose of applying 250.30.~~

Where signal reference structures are installed, they shall be bonded to the equipment grounding conductor provided for the information technology equipment. Any auxiliary grounding electrode(s) installed for information technology equipment shall be installed in accordance with the provisions of 250.54.

Informational Note No. 1: The bonding requirements in the product standards governing this listed equipment ensure that it complies with Article 250.

Informational Note No. 2: Where isolated grounding-type receptacles are used, see 250.146(D) and 406.3(D).

645.27 Selective Coordination

The NEC now requires all overcurrent devices in critical operations data systems be selectively coordinated with all supply-side overcurrent devices.

NEC Language

645.27 Selective Coordination

Critical operations data system(s) overcurrent devices shall be selectively coordinated with all supply side overcurrent protective devices.

Comments

645.2 defines **Critical Operations Data Systems** as "An information technology equipment system that requires continuous operation for reasons of public safety, emergency management, national security, or business continuity."

A lack of selective coordination reduces the reliability of these systems and negates the benefits of selective coordination provisions that are typically designed into these systems.

Article 100 defines **Selective Coordination** as "Localization of an overcurrent condition to restrict outages to the circuit or equipment affected, accomplished by the selection and installation of overcurrent protective devices and their ratings or settings for the full range of available overcurrents, from overload to the maximum available fault current, and for the full range of overcurrent protective device opening times associated with those overcurrents."

ARTICLE 646 Modular Data Centers

646.1 Scope

This article covers modular data centers.

Informational Note No. 1: Modular data centers include the installed information technology equipment (ITE) and support equipment, electrical supply and distribution, wiring and protection, working space, grounding, HVAC, and the like, that are located in an equipment enclosure.

Informational Note No. 2: For further information, see NFPA 75-2013, Standard for the Protection of Information Technology Equipment, which covers the requirements for the protection of information technology equipment and systems in an information technology equipment room.

Article 646 Modular Data Centers

The 2014 added a new article entitled, "*Modular Data Centers.*"

NEC Language

Article 646 Modular Data Centers

I. General

II. Equipment

III. Lighting.

IV. Work Space

Comments

The new article for "*Modular Data Centers*" was added to draw a distinction between data centers that currently fall under the scope of *Article 645, Information Technology Equipment*, and those described in this new article.

Modular Data Centers (MDCs) are an important emerging trend in data center architecture.

Their construction, installation and use result in a unique hybrid piece of equipment that falls somewhere in between a large enclosure and a pre-fabricated building.

The contained equipment in the enclosures or prefabricated buildings would be fully customizable and scalable to provide data center operations, but typically would not be permanently installed.

Article 645 for IT equipment is only applicable to installations that meet the criteria of 645.4.

Otherwise, Article 645 would not be applicable to these modular data centers, and the other articles of the Code would have to be applied. However, it is not always obvious what requirements in the NEC are applicable or how they should be applied given the complexity, customization and scalability of modular data centers.

This new article identifies those areas of the NEC that should be applied to MDCs and also includes additional new requirements where necessary.

ARTICLE 680 Swimming Pools, Fountains, and Similar Installations

680.1 Scope & 680.2 Definitions

The provisions of this article apply to the construction and installation of electrical wiring for, and equipment in or adjacent to, all swimming, wading, therapeutic, and decorative pools; fountains; hot tubs; spas; and hydro massage bathtubs, whether permanently installed or storable, and to metallic auxiliary equipment, such as pumps, filters, and similar equipment. The term body of water used throughout Part I applies to all bodies of water covered in this scope unless otherwise amended.

680.2 Definitions

Storable Swimming, Wading, or Immersion Pools, or Storable/ Portable Spas and Hot Tubs.

The 2014 NEC revised the definition for *storable swimming, wading, or immersion pools* to include *storable/ portable spas and hot tubs*.

NEC Language

680.2 Definitions

Storable Swimming, Wading, or Immersion Pools, or Storable/ Portable Spas and Hot Tubs.

Those that are constructed on or above the ground and are capable of holding water to a maximum depth of 1.0 m (42 in.), or a pool, spa, or hot tub with nonmetallic, molded polymeric walls or inflatable fabric walls regardless of dimension.

Comments

Portable spas and hot tubs systems are similar in design, structure, and installation as storable pools. They are also subject to the same concerns as storable pools, such as, ground-fault circuit-interrupter (GFCI) protection, listing requirements, etc.

The revision to this definition clarifies such things as the requirement at 680.42(C), which describes the need for underwater luminaires to comply with 680.23 and 680.33 for storable or portable spas, and hot tubs and storable pools.

It is difficult for the enforcement community to apply Article 680 safety regulations to storable or portable spas and hot tubs without this revised definition.

680.12 Maintenance Disconnecting Means

The 2014 NEC added fountains to requirements for "*Maintenance Disconnecting Means.*"

NEC Language

680.12 Maintenance Disconnecting Means

One or more means to simultaneously disconnect all ungrounded conductors shall be provided for all utilization equipment other than lighting. Each means shall be readily accessible and within sight from its equipment and shall be located at least 1.5 m (5 ft) horizontally from the inside walls of a pool, spa, fountain, or hot tub unless separated from the open water by a permanently installed barrier that provides a 1.5 m (5 ft) reach path or greater. This horizontal distance is to be measured from the water's edge along the shortest path required to reach the disconnect.

Comments

Under the 2011 NEC, a disconnecting mean(s) is required to simultaneously disconnect all ungrounded conductors for all utilization equipment (other than lighting) for a pool, spa, or hot tub.

This disconnecting mean(s) must be readily accessible and within sight from its equipment.

This disconnecting mean(s) must also generally be located at least 1.5 m (5 ft) horizontally from the inside walls of a pool, spa, or hot tub (unless separated by a permanently installed barrier).

Maintenance disconnecting means rules at 680.12 extended to fountains as well as to pools, spas, or hot tubs.

Concerns that require a maintenance disconnecting means for a pool, spa, or hot tub also hold true for a fountain. The previous text at 680.12 did not contain a disconnecting means provision for signs and outlines lighting installed within fountains as outlined at 600.6.

This requirement at 600.6 also contains a reference back to 680.12.

Without requiring the maintenance disconnecting means for a fountain to be located at least 1.5 m (5 ft) horizontally from the inside walls of a fountain, there are potential hazards for maintenance personnel attempting to make contact with a disconnect while standing in a fountain filled with water.

680.21 Motors

(C) GFCI Protection

The NEC now requires GFCI protection (*regardless of ampacity*) for all single-phase, 120-volt through 240-volt outlets supplying pool pump motors.

NEC Language

680.21 Motors

(C) GFCI Protection

Outlets supplying pool pump motors connected to single-phase, 120 volt through 240 volt branch circuits, ~~rated 15 or 20 amperes, whether by receptacle or by direct connection,~~ shall be provided with ground-fault circuit interrupter protection for personnel.

Comments

Under the previous NEC requirements, a 1.5 hp, 230-volt pool pump motor would have been permitted to be installed on a 25-ampere rated branch circuit without GFCI protection; whereas a 1 hp, 230-volt pool pump motor requiring a 20-ampere overcurrent device would require GFCI protection for personnel.

Concerns of shock hazard potential for 20-ampere branch circuits feeding pool pump motors also apply to a 25-ampere branch circuits or any size branch circuits feeding single-phase pool pump motors.

680.22 Lighting, Receptacles, and Equipment

(A) Receptacles

(1) Required Receptacle, Location

At least one 125-volt, 15- or 20-ampere receptacle on a general-purpose branch circuit must to be located not less than 1.83 m (6 ft) from, and not more than 6.0 m (20 ft) from, the inside wall of all permanently installed pools (*not just dwelling unit pools*).

NEC Language

680.22 Lighting, Receptacles, and Equipment

(A) Receptacles

~~(3)~~ (1) Dwelling Unit(s) Required Receptacle, Location

Where a permanently installed pool is installed ~~at a dwelling unit(s)~~, no fewer than one 125-volt, 15- or 20-ampere receptacle on a general-purpose branch circuit shall be located not less than 1.83 m (6 ft) from, and not more than 6.0 m (20 ft) from, the inside wall of the pool. This receptacle shall be located not more than 2.0 m (6 ft 6 in.) above the floor, platform, or grade level serving the pool.

Comments

The 2014 NEC moved to 680.22(A)(1) this provision for a required 125-volt, 15- or 20-ampere receptacle on a general purpose branch circuit.

The requirement was expanded to all permanently installed pools, not just dwelling unit permanently installed pools. The title was revised from, "*Dwelling Unit(s)*" to "*Required Receptacle, Location.*"

For permanently installed pools, at least one 125-volt, 15- or 20-ampere receptacle must be installed in the vicinity of the pool. This receptacle must be GFCI-protected, be on a general purpose branch circuit, and must be located not closer than 1.83 m (6 ft) and not farther than 6.0 m (20 ft) from the inside wall of the pool.

The NEC requires this receptacle to be located not more than 2.0 m (6½ ft) above the same floor, platform or grade on which the pool is installed.

680.22 Lighting, Receptacles, and Equipment

(A) Receptacles

(2) Circulation and Sanitation System, Location

The 2014 NEC no longer requires receptacles that provide power for pool pump motors located between 3.0 m (10 ft) and 1.83 m (6 ft) from the pool to "*employ a locking configuration.*"

NEC Language

680.22 Lighting, Receptacles, and Equipment

(A) Receptacles

~~(1)~~(2) Circulation and Sanitation System, Location

Receptacles that provide power for water pump motors or for other loads directly related to the circulation and sanitation system shall be located at least 3.0 m (10 ft) from the inside walls of

the pool, or not less than 1.83 m (6 ft) from the inside walls of the pool if they meet all of the following conditions:

- (1) Consist of single receptacles
- ~~(2) Employ a locking configuration~~
- ~~(3)~~(2) Are of the grounding type
- ~~(4)~~(3) Have GFCI protection

Comments

The NEC permits a 125-volt, 15- or 20-ampere convenience receptacle to be located not less than 1.83 m (6 ft) from the inside walls of the pool with no restriction of a locking configuration.

Since these convenience receptacles do not require a locking configuration, there is no need for the circulation and sanitation receptacle to have a locking configuration.

Any 15- and 20-ampere, single-phase, 125-volt receptacles located within 6.0 m (20 ft) of the inside walls of a pool must be provided with ground-fault circuit interrupter (GFCI) protection.

680.22 Lighting, Receptacles, and Equipment

(B) Luminaires, Lighting Outlets, and Ceiling-Suspended (Paddle) Fans

(6) Low-Voltage Luminaires

The NEC now permits specific low-voltage luminaires to be installed within 1.5 m (5 ft) of the inside walls of permanently installed pools.

NEC Language

680.22 Lighting, Receptacles, and Equipment

(B) Luminaires, Lighting Outlets, and Ceiling-Suspended (Paddle) Fans

(6) Low-Voltage Luminaires

Listed low-voltage luminaires not requiring grounding, not exceeding the low-voltage contact limit, and supplied by listed transformers or power supplies that comply with 680.23(A)(2) are permitted to be located less than 1.5 m (5 ft) from the inside walls of the pool.

Comments

These low-voltage luminaires must be of the type that does not require connection to an equipment grounding conductor.

These luminaires cannot exceed the voltage limitations defined in the definition of low voltage contact limit at 680.2.

These luminaires must also be supplied by listed transformers or power supplies that comply with 680.23(A)(2) for transformers or power supplies listed for swimming pool and spa use.

The new provisions at 680.22(B) (6) will permit low-voltage installations that are already being installed around numerous swimming pools. Without this new language these low-voltage luminaires would not be Code-compliant.

680.25 Feeders

(A) Wiring Methods.

(1) Feeders

Exception

The NEC revised the exception allowing an "*existing*" feeder between an "*existing*" remote swimming pool panel board and service equipment to be run in flexible metal conduit or an approved cable assembly. The NEC allows this exception for any feeder and remote swimming pool panel board.

In addition, cable assembly is required to have an "*insulated*" EGC.

NEC Language

680.25 Feeders

These provisions shall apply to any feeder on the supply side of panelboards supplying branch circuits for pool equipment covered in Part II of this article and on the load side of the service equipment or the source of a separately derived system.

(A) Wiring Methods.

(1) Feeders

Feeders shall be installed in rigid metal conduit or intermediate metal conduit. The following wiring methods shall be permitted if not subject to physical damage:

- (1) Liquidtight flexible nonmetallic conduit
- (2) Rigid polyvinyl chloride conduit
- (3) Reinforced thermosetting resin conduit
- (4) Electrical metallic tubing where installed on or within a building
- (5) Electrical nonmetallic tubing where installed within a building
- (6) Type MC cable where installed within a building and if not subject to corrosive environment

Exception: A feeder within a one-family dwelling unit or two-family dwelling unit between remote panelboard and service equipment shall be permitted to run in flexible metal conduit or an approved cable assembly that includes an insulated equipment grounding conductor within its outer sheath. The equipment grounding conductor shall comply with 250.24(A)(5).

Comments

680.25(A)(1) did not change the requirements for wiring methods for swimming pool panelboard feeders, but the exception for an existing feeder between an existing remote panelboard and service equipment was deleted.

At new construction, a new feeder is "*existing*" the next day after it has been installed. In order to determine the wiring method for a feeder to a swimming pool panel board, therefore it makes no difference if the feeder and the remote panel board are "*existing*" or not.

680.26 Equipotential Bonding

(C) Pool Water

The 2014 NEC revised the requirement for "*bonding*" of pool water.

NEC Language

680.26 Equipotential Bonding

(C) Pool Water

~~An intentional bond of a minimum conductive surface area of 5800 mm² (9 in.²) shall be installed in contact with the pool water. This bond shall be permitted to consist of parts that are required to be bonded in 680.26(B). Pool water shall have an electrical connection to one or more of the bonded parts described in 680.26(B).~~

Where none of the bonded parts is in direct connection with the pool water, the pool water shall be in direct contact with an approved corrosion-resistant conductive surface that exposes not less than 5800 mm² (9 in.²) of surface area to the pool water at all times. The conductive surface shall be located where it is not exposed to physical damage or dislodgement during usual pool activities, and it shall be bonded in accordance with 680.26(B).

Comments

The 2011 NEC called for an "intentional bond" to the pool water from some conductive surface with a minimum surface area of 5800 mm² (9 in.²) in contact with the pool water.

This bond to the conductive surface from the pool water was permitted to consist of parts that are required to be bonded in 680.26(B), such as metal ladders, metal railings, metal underwater luminaire housings, etc.

The same provisions are still in place, but the 2014 NEC use different words to avoid using the terms *intentional bond* or *bond*.

This provision in the 2014 NEC ensures a good undisputable connection (*bonding*) between the equipotential bonding grid described at 680.26(B) and the actual pool water.

680.42 Outdoor Installations

(B) Bonding

The 2014 NEC no longer requires equipotential bonding of perimeter surfaces for outdoor spas and hot tubs, provided (4) specific conditions are met.

NEC Language

680.42 Outdoor Installations

A spa or hot tub installed outdoors shall comply with the provisions of Parts I and II of this article, except as permitted in 680.42(A) and (B), that would otherwise apply to pools installed outdoors.

(B) Bonding

Bonding by metal to metal mounting on a common frame or base shall be permitted. The metal bands or hoops used to secure wooden staves shall not be required to be bonded as required in 680.26.

Equipotential bonding of perimeter surfaces in accordance with 680.26(B)(2) shall not be required to be provided for spas and hot tubs where all of the following conditions apply:

- (1) The spa or hot tub shall be listed as a self-contained spa for aboveground use.
- (2) The spa or hot tub shall not be identified as suitable only for indoor use.
- (3) The installation shall be in accordance with the manufacturer's instructions and shall be located on or above grade.
- (4) The top rim of the spa or hot tub shall be at least 71 cm (28 in.) above all perimeter surfaces that are within 76 cm (30 in.), measured horizontally from the spa or hot tub. The height of nonconductive external steps for entry to or exit from the self-contained spa shall not be used to reduce or increase this rim height measurement.

Informational Note: For information regarding listing requirements for self-contained spas and hot tubs, see ANSI/UL 1563 - 2010, Standard for Electric Spas, Equipment Assemblies, and Associated Equipment.

Comments

The NEC requires a spa or hot tub installed outdoors to comply with the provisions of Parts I and II of Article 680.

Section 680.42(A) and (B) provides some specific conditions that would supersede the provisions of Parts I and II of Article 680; but, otherwise, an outdoor spa or hot tub is to be treated like a permanently installed pool installed outdoors.

Section 680.42(B) states that bonding by metal-to-metal mounting on a common frame or base is permitted, and the metal bands or hoops used to secure wooden staves are not required to be bonded as required in 680.26 for equipotential bonding.

The 2014 NEC incorporated the concepts of *TIA 70-11-1* and added them to 680.42(B). These new provisions eliminate equipotential bonding requirements for listed self-contained spas or hot tubs for aboveground use.

In order for these listed self-contained spas or hot tubs to avoid 680.26 equipotential bonding requirements, the four specific conditions must be satisfied.

680.57 Signs

(A) General

(B) Ground-Fault Circuit-interrupter Protection for Personnel.

The 2014 NEC now requires GFCI protection for either the branch circuit or feeder supplying *electric signs installed within a fountain, but not both.*

680.57 Signs

(A) General

This section covers electric signs installed within a fountain or within 3.0 m (10 ft) of the fountain edge.

(B) Ground-Fault Circuit-interrupter Protection for Personnel.

~~All~~ Branch circuits or feeders supplying the sign shall have ground-fault circuit-interrupter *protection for personnel.*

Comments

Signs installed in or within close proximity to fountains are becoming more commonplace.

The supply circuits to these signs must provide GFCI protection for personnel.

The provisions for signs in fountains were first addressed in the 1999 NEC. This is the genesis of the "all" circuits supplying electric signs within a fountain requiring GFCI protection addressed at 680.57.

Prior to this 1999 NEC text, the Code called for GFCI protection to be installed in the branch circuit supplying fountain equipment. A revision to the text at 680.57(B) now requires GFCI protection in either the branch circuit or the feeder supplying the sign, but not both.

This revision will make it clear that GFCI protection for these fountain signs was intended for power circuits only and the required GFCI protection was not intended for the feeder and the branch circuit simultaneously.

ARTICLE 690 Solar Photovoltaic (PV) Systems

690.1 Scope & 690.2 Definitions

The 2014 NEC now states that the provisions of this article apply to solar PV electrical energy systems, including the array circuit(s), inverter(s), and controller(s) for such systems.

[See Figure 690.1(a) and Figure 690.1(b).]

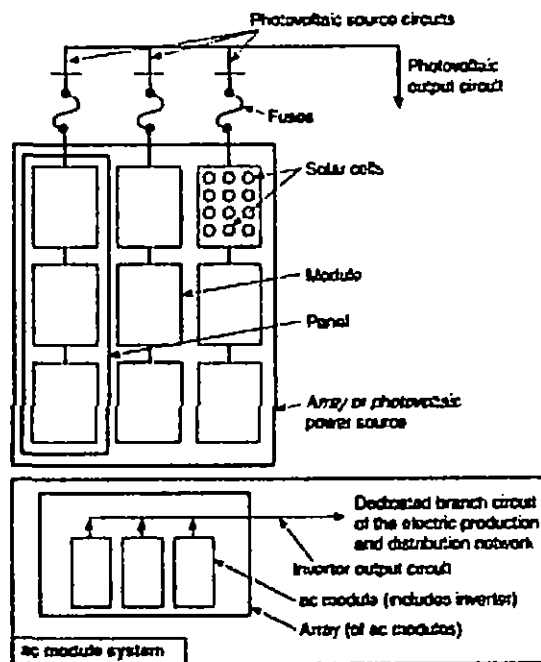

Notes.

1. These diagrams are intended to be a means of identification for photovoltaic system components, circuits, and connections.
2. Disconnecting means required by Article 230, Part III, are not shown.
3. System grounding and equipment grounding are not shown. See Article 250, Part V.

Figure 690.1(a) Identification of Solar Photovoltaic System Components.

Source: NEC 2012

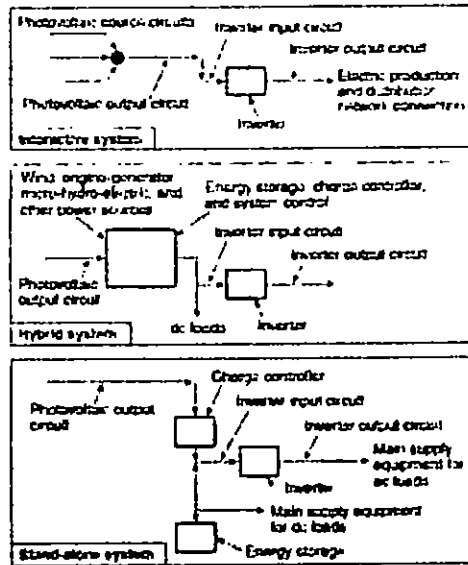

Notes:
 1. These diagrams are intended to be a means of identification for photovoltaic system components, circuits, and connections.
 2. Disconnecting means and overcurrent protection required by Article C90, Part III, are not shown.
 3. System grounding and equipment grounding are not shown. See Article C90, Part V.
 4. Custom designs occur in each configuration, and some components are optional.

Figure 690.10(i) Identification of Solar Photovoltaic System Components in Common System Configurations.

Source: NEC 2012

Solar PV systems covered by this article may be interactive with other electrical power production sources or stand-alone, with or without electrical energy storage such as batteries. These systems may have ac or dc output for utilization.

690.2 Definitions

The NEC added two new definitions to Article 690:

- DC to DC Converter** and
- Direct Current (dc) Combiner.**

NEC Language

ARTICLE 690 Solar Photovoltaic (PV) Systems

690.2 Definitions

DC to DC Converter. A device installed in the PV source circuit or PV output circuit that can provide an output dc voltage and current at a higher or lower value than the input dc voltage and current.

Direct Current (dc) Combiner. A device used in the PV source and PV output circuits to combine two or more dc circuit inputs and provide one dc circuit output.

Comments

The 2011 NEC used these two terms, but it did not define them.

DC to DC Converter is a device that can be installed in either the PV source circuit or PV output circuit that can provide an output dc voltage and current at a higher or lower value than the input dc voltage and current.

A **Direct Current (dc) Combiner** is a device used in the PV source and PV output circuits to combine two or more dc circuit inputs, providing one dc circuit output.

These devices are becoming more common and have specific unique requirements. Since the output parameters of these devices can be different from the input parameters, the rating of equipment on the output side may need to be different from that on the input. This definition also makes it clear that the PV source or output circuit ends at the input to the device by defining it as dc utilization equipment. This prevents the application of 690.7(A), Maximum PV System Voltage, requirements to the output of these devices.

690.5 Ground-Fault Protection

(A) Ground-Fault Detection and Interruption

The 2014 NEC revised requirements for ground-fault protection devices or systems for PV systems into a list format. This ground-fault protection device or system must also be listed for providing PV ground-fault protection.

NEC Language

690.5 Ground-Fault Protection

Grounded dc PV arrays shall be provided with dc ground-fault protection meeting the requirements of 690.5(A) through (C) to reduce fire hazards. Ungrounded dc PV arrays shall comply with 690.35.

Exception No. 1: Ground-mounted or pole-mounted PV arrays with not more than two paralleled source circuits and with all dc source and dc output circuits isolated from buildings shall be permitted without ground-fault protection.

~~**Exception No. 2:** Photovoltaic arrays installed at other than dwelling units shall be permitted without ground-fault protection if each equipment grounding conductor is sized in accordance with 690.45.~~

(A) Ground-Fault Detection and Interruption

The ground-fault protection device or system shall:

- (1)** Be capable of detecting a ground-fault in the PV array dc current carrying conductors and components, including any intentionally grounded conductors,
- (2)** Interrupt the flow of fault current,

(3) Provide an indication of the fault, and

(4) Be listed for providing PV ground-fault protection.

Automatically opening the grounded conductor of the faulted circuit for measurement purposes or to interrupt the ground-fault current path shall be permitted. If a grounded conductor is opened to interrupt the ground-fault current path, all conductors of the faulted circuit shall be automatically and simultaneously opened.

Manual operation of the main PV dc disconnect shall not activate the ground-fault protection device or result in grounded conductors becoming ungrounded.

Comments

The NEC requires grounded dc photovoltaic arrays to be provided with dc ground-fault protection (GFP) for the reduction of fire hazards.

Ungrounded dc photovoltaic arrays are required to comply with 690.35, which are the provisions for ungrounded PV power systems. Two exceptions to this GFP rule applied:

1. The first exception dealt with ground-mounted or pole-mounted PV arrays having not more than two paralleled source circuits and with all dc source and dc output circuits isolated from buildings.
2. The second exception: PV arrays installed at other than dwelling units with equipment grounding conductor is sized in accordance with 690.45.

The GFP device or system had to be capable of detecting a ground-fault current, interrupting the flow of fault current, and providing an indication of the fault.

Automatically opening the grounded conductor of the faulted circuit to interrupt the ground-fault current path shall be permitted if all conductors of the faulted circuit automatically and simultaneously open as well.

Manual operation of the main PV dc disconnect cannot activate the GFP device or result in grounded conductors becoming ungrounded.

In the 2014 NEC, the provisions for dc ground-fault protection (GFP) for grounded dc photovoltaic arrays were brought forward with some revisions.

1. The second exception for other than dwelling units was deleted.
2. The conditions for the GFP device or system were formatted into a list format.
3. A fourth condition was added requiring the GFP device or system to be "listed" for providing PV ground-fault protection.
4. A change allowing the automatic opening of the grounded conductor "for measurement purposes" or to interrupt the ground-fault current path allows for interruption of the grounded conductor to make the isolation measurement.

690.7 Maximum Voltage

(F) Disconnects and Overcurrent Protection

The 2014 NEC added a new subsection for "*Disconnects and Overcurrent Protection*" at 690.7, *Maximum Voltage*, dealing with batteries and other energy storage devices.

NEC Language

690.7 Maximum Voltage

(F) Disconnects and Overcurrent Protection

Where energy storage device output conductor length exceeds 1.5 m (5 ft), or where the circuits pass through a wall or partition the installation shall comply with (1) through (5):

(1) A disconnecting means and overcurrent protection shall be provided at the energy storage device end of the circuit. Fused disconnecting means or circuit breakers are acceptable.

(2) Where fused disconnecting means are used, the "Line" terminals of the disconnecting means shall be connected toward the energy storage device terminals.

(3) Overcurrent devices or disconnecting means shall not be installed in energy storage device enclosures where explosive atmospheres can exist.

(4) A second disconnecting means located at the connected equipment shall be installed where the disconnecting means required by (1) is not within sight of the connected equipment.

(5) Where the energy storage device disconnecting means is not within sight of the PV system ac and dc disconnecting means, placards or directories shall be installed at the locations of all disconnecting means indicating the location of all disconnecting means.

Comments

Where energy storage device output conductor length exceeds 1.5 m (5 ft), or where the circuits pass through a wall or partition, the installation is now required to comply with five specific provisions added to the 2014 NEC. See Code language provided for specific conditions.

The new provisions added to 690.7 to provide requirements for disconnects and overcurrent protection for batteries and other energy storage devices frequently used in the PV industry.

Batteries and other energy storage devices represent significant sources of current (10,000 amps or more).

Circuits connected to these sources must be protected with overcurrent protection. These circuits are bidirectional and there is some confusion as to where the disconnects and overcurrent protection are required since there are two supply sources.

Operating voltages for residential systems can operate above 300 volts dc. A switched disconnecting means is required to allow rapid disconnection of the batteries from the circuit

under connected equipment failure and during maintenance. It can be difficult to install this *disconnecting equipment when the cable lengths are short, such as under 1.5 m (5 ft).*

Where energy storage device output conductor length exceeds 1.5 m (5 ft), or where the circuits pass through a wall or partition, the NEC now requires an installation to comply with five specific provisions.

The maximum distance that the product standard and Underwriters Laboratories (UL) generally allows for unprotected cable lengths when testing PV power centers is 1.5 m (5 ft).

690.9 Overcurrent Protection

The 2014 NEC revised "*Overcurrent Protection*" requirements by grouping similar overcurrent protection requirements for PV systems together in order to make Article 690 easier to use.

NEC Language

690.9 Overcurrent Protection

(A) Circuits and Equipment

(B) ~~Power Transformers~~ Overcurrent Device Ratings

(C) ~~Photovoltaic Source Circuits~~ Direct-Current Rating.

(D) ~~Direct-Current Rating~~ Photovoltaic Source and Output Circuits.

(E) Series Overcurrent Protection.

(F) Power Transformers.

(See NEC for complete text)

Comments

This revision was part of a series of revisions and re-origination, which sought to group similar requirements for PV systems together in order to make Article 690 more user-friendly.

The NEC added language to insure that listed equipment is used to provide this overcurrent protection. Overcurrent protection devices in PV source and output circuits are subject to wide operating current and temperature cycling, high ambient temperatures, low clearing currents and high open-circuit voltages.

Product standards have been created specifically for PV dc system overcurrent protection (both fuses and circuit breakers). The added language in these revisions will make it clear to the inspector and installer that devices specifically designed for these systems are required.

690.10 Stand-Alone Systems

(E) Back-fed Circuit Breakers

The 2014 NEC removed "*Utility-interactive systems*" from the requirements of having to have back-fed circuit breakers secured in place by an additional fastener.

The Code also added "*Multimode*" inverter output in standalone systems to the requirement.

NEC Language

690.10 Stand-Alone Systems

The premises wiring system shall be adequate to meet the requirements of this Code for a similar installation connected to a service.

The wiring on the supply side of the building or structure disconnecting means shall comply with the requirements of this Code, except as modified by 690.10(A) through (E).

(E) Back-fed Circuit Breakers.

Plug-in type back-fed circuit breakers connected to a standalone or multimode inverter output in either stand-alone or utility-interactive systems shall be secured in accordance with 408.36(D). Circuit breakers that are marked "line" and "load" shall not be back-fed.

Comments

The 2014 NEC removed the requirement for a utility-interactive system to have its back-fed circuit breakers secured in place by an additional fastener. It also added multimode inverter output in stand-alone systems to the requirement.

Certified/listed multimode inverters ensure safety for the power line and utility personnel anytime the utility is shutdown or operates abnormally.

690.12 Rapid Shutdown of PV Systems on Buildings

The 2014 NEC added new provisions for rapid shutdown of PV systems on buildings.

NEC Language

690.12 Rapid Shutdown of PV Systems on Buildings

PV system circuits installed on or in buildings shall include a rapid shutdown function that controls specific conductors in accordance with 690.12(1) through (5) as follows.

(1) Requirements for controlled conductors shall apply only to PV system conductors of more than 1.5 m (5 ft) in length inside a building, or more than 3 m (10 ft) from a PV array.

(2) Controlled conductors shall be limited to not more than 30 volts and 240 VA within 10 seconds of rapid shutdown initiation.

- (3) Voltage and power shall be measured between any two conductors and between any conductor and ground.
- (4) The rapid shutdown initiation methods shall be labeled in accordance with 690.56(B).
- (5) Equipment that performs the rapid shutdown shall be listed and identified.

Comments

The 2014 NEC added a new 690.12 entitled "*Rapid Shutdown of PV Systems on Buildings.*" This applies to PV systems installed on building roofs and would require that PV source circuits be de-energized from all sources within 10 seconds of when the utility supply is de-energized or when the PV power source disconnecting means is opened.

The "*rapid shutdown*" provision is intended to increase the electrical and fire safety of PV systems on buildings. This incorporates a significant improvement in safety for rooftop PV systems based on the safety concerns of the first and second responders of the emergency and fire service communities during emergency operations on PV-equipped buildings and structures.

The use of PV systems is increasing at a rapid pace. As a result of greater utilization, traditional firefighter tactics for suppression, ventilation, and overhaul have been complicated, leaving firefighters vulnerable to severe hazards.

This new section addresses the de-energizing of rooftop wiring, leaving only the module wiring and internal conductors of the module still energized.

690.31 Methods Permitted

The NEC revised and reorganized Section 690.31 for clarity and to bring PV wiring methods to one location.

NEC Language

690.31 Methods Permitted (Wiring Methods)

(A) Wiring Systems

(B) Identification and Grouping [Was 690.4(B)]

(C) Single-Conductor Cable [Was 690.31(B)]

(D) Multiconductor Cable [New]

(E) Flexible Cords and Cables [Was 690.31(C)]

Table 690.31(E) Correction Factors [New]

Table 690.31(E) Correction Factors

Ambient Temperature (°C)	Temperature Rating of Conductor				Ambient Temperature (°F)
	60°C (140°F)	75°C (167°F)	90°C (194°F)	105°C (221°F)	
30	1.00	1.00	1.00	1.00	86
31-35	0.91	0.94	0.96	0.97	87-95
36-40	0.82	0.88	0.91	0.93	96-104
41-45	0.71	0.82	0.87	0.89	105-113
46-50	0.58	0.75	0.82	0.86	114-122
51-55	0.41	0.67	0.76	0.82	123-131
56-60	—	0.58	0.71	0.77	132-140
61-70	—	0.33	0.58	0.68	141-158
71-80	—	—	0.41	0.58	159-176

Source: NEC 2012

(F) Small-Conductor Cables [Was 690.31(D)]

(G) Direct-Current Photovoltaic Source and DC Output Circuits On or Inside a Building [Was 690.31(E)]

(H) Flexible, Fine-Stranded Cables [Was 690.31(F)]

(I) Bipolar Photovoltaic Systems [Was 690.4(G)]

(J) Module Connection Arrangement [Was 690.4(C)]

Comments

The 2014 NEC revised and reorganized Section 690.31 to incorporate various wiring method provisions from previous 690.4 and 690.14. The previous and revised portions of 690.14 were variously incorporated into 690.13, 690.31, and others.

690.35 Ungrounded Photovoltaic Power Systems

(C) Ground-Fault Protection

The 2014 NEC now requires ground-fault protection for ungrounded PV systems to be listed.

NEC Language

690.35 Ungrounded Photovoltaic Power Systems

Photovoltaic power systems shall be permitted to operate with ungrounded PV source and output circuits where the system complies with 690.35(A) through (G).

(C) Ground-Fault Protection

All photovoltaic source and output circuits shall be provided with a ground-fault protection device or system that complies with (1) through (4):

- (1) Detects a ground fault(s) in the PV array dc current carrying conductors and components
- (2) Indicates that a ground fault has occurred
- (3) Automatically disconnects all conductors or causes the inverter or charge controller connected to the faulted circuit to automatically cease supplying power to output circuits
- (4) Be listed for providing PV ground fault protection.

Comments

The NEC permits photovoltaic power systems to operate with ungrounded PV source and output circuits where the system complies with the specific conditions of 690.35(A) through (G).

690.35(C) requires all PV source and output circuits to be provided with a ground-fault protection (GFP) device or system that detects a ground fault, indicates that a ground fault has occurred, and automatically disconnects all conductors, or causes the inverter or charge controller connected to the faulted circuit to automatically cease supplying power to output circuits.

Existing ground-fault protection (GFP) techniques have indicated that additional protection is necessary against high ground faults that can readily occur on PV systems. Inadequate GFP protection has resulted in several fires in PV systems over the last few years. GFP device or system is now required to detect ground fault(s) in the PV array dc current-carrying conductors and components. This adds an additional array isolation measurement prior to export of current.

The 2014 NEC also added new provisions to require the GFP device or system to be listed for providing PV ground-fault protection. This allows the *authority having jurisdiction (AHJ)* to rely upon the listing to verify the functionality of this extremely important protection system. This also improves the enforceability of the GFP requirements for ungrounded PV systems.

690.41 System Grounding

The 2014 NEC revised system grounding requirements for PV systems into a list format for clarity.

NEC Language

690.41 System Grounding

Photovoltaic systems shall comply with one of the following:

- (1) Ungrounded systems shall comply with 690.35
- (2) Grounded 2-wire systems ~~with voltage over 50 volts~~ shall have one conductor ~~solidly~~ grounded or be impedance grounded, and the system shall comply with 690.5
- (3) Grounded bipolar systems shall have the reference (center tap) conductor ~~solidly~~ grounded or be impedance grounded, and the system shall comply with 690.5

(4) Other methods that accomplish equivalent system protection in accordance with 250.4(A) that utilize with equipment listed and identified for the use.

Exception: Systems complying with 690.35.

Comments

The 2014 NEC revised this section for "*System Grounding*" into a list format for clarity. The reference to "over 50" volts was deleted since the list now includes all types of PV systems at any voltage. The term solidly grounded was removed for consistency.

An allowance for impedance grounding and the reference to 690.5, *Ground-Fault Protection*, were also added for clarity when grounded 2-wire and bipolar PV systems are installed.

System grounding requirements for PV systems have been revised into a list format for clarity, and further revision also makes the intent of this section clearer.

The NEC deleted the previous reference to "over 50" volts to remove this restriction as the new list format at 690.41 now includes all types of PV systems at any voltage.

The NEC also deleted the term *solidly grounded* in an effort to make this Code language consistent with the PV inverters and other equipment product standards where an overcurrent device is allowed to make the dc bonding jumper as a part of the required ground-fault protective device.

Additional text was added to allow impedance grounding; and references to 690.5 (ungrounded PV systems with ground-fault protection) were also added for clarity when grounded 2-wire and bipolar PV systems are installed.

690.47 Grounding Electrode System

(D) Additional Auxiliary Electrodes for Array Grounding

The 2014 NEC now requires an auxiliary grounding electrode system to be installed in accordance with 250.52 and 250.54 at all ground- and pole-mounted PV arrays and as close as practicable to roof-mounted PV arrays.

NEC Language

690.47 Grounding Electrode System

(D) Additional Auxiliary Electrodes for Array Grounding

A grounding electrode shall be installed in accordance with 250.52 and 250.54 at the location of all ground- and pole-mounted photovoltaic arrays and as close as practicable to the location of roof-mounted photovoltaic arrays.

The electrodes shall be connected directly to the array frame(s) or structure. The dc grounding electrode conductor shall be sized according to 250.166. Additional electrodes are not permitted to be used as a substitute for equipment bonding or equipment grounding conductor

requirements. The structure of a ground- or pole mounted photovoltaic array shall be permitted to be considered a grounding electrode if it meets the requirements of 250.52. Roof mounted photovoltaic arrays shall be permitted to use the metal frame of a building or structure if the requirements of 250.52(A)(2) are met.

Exception No. 1: Array grounding electrode(s) shall not be required where the load served by the array is integral with the array.

Exception No. 2: Additional array grounding electrode(s) shall not be required if located within 1.8 m (6 ft) of the premises wiring electrode.

Comments

This language at 690.47(D) was inadvertently removed from the 2011 NEC as it appeared in the 2008 NEC.

Note: The yellow shaded text at this Code language is compared to 2008 NEC text at 690.47(D).

The 2014 NEC added new provisions at 690.47(D) for "*Additional Auxiliary Electrodes for Array Grounding.*" This Code language appeared in some form from the 1996 to the 2008 NEC.

The 2014 NEC added requirements for auxiliary grounding electrodes that did not appear in the previous 2008 NEC. This subsection revived from the 2008 NEC requires a grounding electrode system to be installed at the location of all ground- and pole-mounted PV arrays and as close as practicable to the location of roof-mounted PV arrays. This grounding electrode system must meet the requirements of 250.52 for grounding electrodes and 250.54 for auxiliary grounding electrodes. These grounding electrodes are required to be connected directly to the array frame(s) or structure.

See 690.47(D) Code text for additional requirements and two exceptions.

The large quantity of conductive material that is added to a roof when a PV system is installed increases the likelihood of a lightning strike. This PV grounding electrode system would help to minimize the effects of such a lightning strike. The purpose of this PV grounding electrode is two-fold:

1. The primary purpose is to maintain the frames of the PV array to as close to local earth voltage potential as possible. This is preferable to relying on a potentially long equipment grounding conductor back to a grounding electrode, perhaps on another structure. This situation presents a potential shock hazard and necessitates these PV arrays be grounded to a local grounding electrode.
2. The secondary purpose of this PV grounding electrode is to provide a simple and direct path to earth for any static charge that may build up in storm or lightning activities.

The 2014 NEC added the word "*Auxiliary*" to the title and referenced in the text, along with a reference to 250.54, to indicate that this PV grounding electrode system is not required to be tied into the premises grounding electrode system.

This tie-in with auxiliary grounding electrodes also makes it clear that if multiple PV auxiliary grounding electrodes are installed, they do not need to be bonded together by a dedicated bonding jumper. These grounding electrode(s) will be permitted to be connected to the equipment grounding conductors of the branch circuit(s) or feeder(s) to these PV arrays.

690.81 Listing

The 2014 NEC added a new 690.81 for listing requirements for PV wire used with systems over 600 volts but not exceeding 2000 volts.

NEC Language

690.81 Listing

Products listed for photovoltaic systems shall be permitted to be used and installed in accordance with their listing. Photovoltaic wire that is listed for direct burial at voltages above 600 volts but not exceeding 2000 volts shall be installed in accordance with Table 300.50, Column 1.

Table 300.50 Minimum Cover^a Requirements

Circuit Voltage	General Conditions (not otherwise specified)						Special Conditions (use if applicable)					
	Column 1		Column 2		Column 3		Column 4		Column 5		Column 6	
	mm	in.	mm	in.	mm	in.	mm	in.	mm	in.	mm	in.
	Direct-Buried Cables ^b		RTRC, PVC, and HDPE Conduit ^c		Rigid Metal Conduit and Intermediate Metal Conduit		Raceways Under Buildings or Exterior Concrete Slabs, 100 mm (4 in.) Minimum Thickness ^d		Cables in Airport Runways or Adjacent Areas Where Trespass Is Prohibited		Areas Subject to Vehicular Traffic, Such as Thoroughfares and Commercial Parking Areas	
Over 1000 V through 22 kV	750	30	450	18	150	6	100	4	450	18	600	24
Over 22 kV through 40 kV	900	36	600	24	150	6	100	4	450	18	600	24
Over 40 kV	1000	42	750	30	150	6	100	4	450	18	600	24

Source: NEC 2011

Comments

This listing requirement did not exist in the 2011 NEC.

Products listed for photovoltaic systems are permitted to be used and installed in accordance with their listing. PV wire that is listed for direct burial at voltages above 600 volts but not exceeding 2000 volts is required to be installed in accordance with Table 300.50, Column 1.

It has become common practice in large utility-scale solar PV installations to direct bury 2000-volts rated conductors used to deliver power from combiner boxes to the inverter. Since these installations are not accessible to the public, and maintenance and supervision ensure that only qualified persons service the installed cable, direct-buried single-conductor installations are appropriate for these installations.

There are currently listed PV wire products available that are rated at up to 2000 volts that are also listed for direct burial. New product standards are being developed for above 600-volts equipment and other electrical systems components; and this new Article 690 listing requirement will allow these products to be used where applicable and available.

Article 694 Wind Electric Systems

694.1 Scope

The provisions of this article apply to wind (turbine) electric systems that consist of one or more wind electric generators. These systems can include generators, alternators, inverters, and controllers.

Informational Note: Wind electric systems can be interactive with other electrical power production sources or might be stand-alone systems. Wind electric systems can have ac or dc output, with or without electrical energy storage, such as batteries. See Informational Note Figure 694.1(a) and Informational Note Figure 694.1(b).

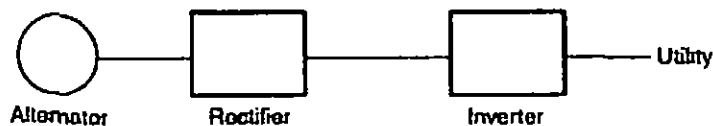

Informational Note Figure 694.1(a) Identification of Wind Electric System Components — Interactive System.

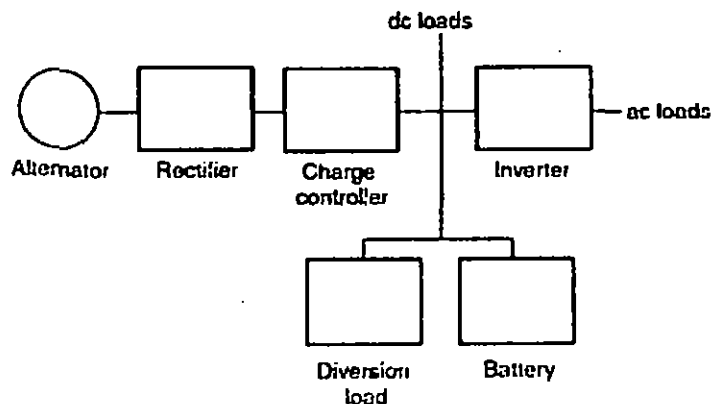

Informational Note Figure 694.1(b) Identification of Wind Electric System Components — Stand-Alone System.

Source: NEC 2014

Article 694 Wind Electric Systems

The 2014 NEC revised the title, scope and appropriate text throughout Article 694 by removing the word "small," leaving the subject of the article simply "Wind Electric Systems."

NEC Language

Specific changes in NEC 2014 are as follows:

Article 694 Small Wind Electric Systems

694.1 Scope

The provisions of this article apply to ~~small~~ wind (turbine) electric systems that consist of one or more wind electric generators ~~with individual generators having a rated power up to and including 100 kW.~~

These systems can include generators, alternators, inverters, and controllers.

Informational Note: ~~Small~~ Wind electric systems can be interactive with other electrical power production sources or might be stand-alone systems. ~~Small~~ Wind electric systems can have ac or dc output, with or without electrical energy storage, such as batteries. See Informational Note Figures 694.1(a), ~~No. 1~~ and 694.1(b), ~~No. 2~~.

Comments

Article 694 applied to small wind (turbine) electric systems that consist of one or more wind electric generators with individual generators having a rated power up to and including 100 kW.

Article 694 now applies to wind (turbine) electric systems that consist of one or more wind electric generators. This article is no longer limited to wind (turbine) electric systems rated 100 kW and below.

Article 694 for "Small Wind Electric Systems" was introduced in the 2011 NEC. With the increasing number of wind turbines being installed across the country, there was no specific article to address the particular characteristics of these unique electrical systems. The electrical safety of these installations was improved by adding clear requirements for grounding and other aspects of the electrical installation. Since wind turbine towers are typically tall structures, other considerations needed to be addressed such as lightning strikes and as such deserve special attention when connected to a premises electrical system.

Experience over the last Code cycle has also shown that there is no significant difference between an electrical installation for a wind turbine sized at 100 kW or less and that for one rated above 100 kW. The requirements developed for "small" wind turbine systems should have, and now have been, applied for intermediate and large wind turbines as well. The product standards for wind turbines, UL 6141, Wind Turbine Converters and Interconnection Systems Equipment and UL 6142, Small Wind Turbine Systems both draw the same conclusion: there is no need to draw a distinction between small, intermediate, and large wind electric systems. Rules for the larger wind turbines previously did not exist in Article 694 due to the limitation of the scope of the article to 100 kW or less.

Conclusion

Summary

You have completed Chapter 6 of this course on *Changes in the 2014 NEC*.

Resources

References

NFPA. *2014 National Electrical Code (NEC)*, 2013.

International Association of Electrical Inspectors, Richardson, Texas and National Fire Protection Association, Inc. Quincy, MA. *Analysis of Changes – NEC 2014*, 2013.

The designations "National Electrical Code" and "NEC" refer to NFPA 70, National Electrical Code, which is a registered trademark of the National Fire Protection Association.

Author Biography

Neal L. Burdick

Neal Burdick has over 30 years of experience and is currently a construction inspector for the City of Tampa. He is a registered instructor for the Electrical Council of Florida and is the author and instructor of a State of Florida approved Electrical Contractor's Licensing Board course.

Neal is an accomplished and exceptionally knowledgeable professional with a solid background in electrical and building inspections, as well as code compliance. He is recognized as an expert in this industry. He is an active member of IAEI, BOAF, ECF, and related industry associations. Mr. Burdick conducts training to building officials, engineers, plans examiners, inspectors, electrical contractors, and apprentices throughout the State of Florida.

Attachment #2: Instructor Information

Course Instructor:

Neal Burdick

Florida Certified Electrical Contractor EC# 0002179

Mr. Burdick's resume is attached for review.

Neal L. Burdick

9840 Mainlands Blvd. West, Pinellas Park, FL 33782
Phone: 813-446-9848

PROFESSIONAL WORK HISTORY

CITY OF TAMPA, Tampa, FL 2005 – March 2013

Electrical / Construction Inspector II

Inspect all phases of electrical installations (residential, commercial, and industrial) permitted with the City of Tampa, to include underground, rough-in, and final inspections. Retrieve inspection requests, plan, and schedule, perform, and document an average of 18 to 25 field inspections daily. Verify on - site permit documentation and examine blueprints to ensure compliance with NEC and Florida Building Code requirements. Collaborate with contractors to identify and correct existing and potential deficiencies. Trained Building Inspectors on electrical segment of One / Two Family Dwelling Electrical Inspector examination; successfully tutored four Inspectors to secure their licenses.

CERTIFIED TEACHING / INSTRUCTION

PINELLAS COUNTY SCHOOL BOARD, Largo, FL 2011 - Present

Adult Education Trade Instructor (Tuesday / Thursday nights)

4th - year apprenticeship instructor for Bay Area Electrical Apprenticeship Program at Pinellas Technical Education Center (pTEC) Clearwater campus. Create lesson plans, curriculum, quizzes, and tests in preparation for the Electrical Journeyman Exam.

- Selected as keynote speaker for graduation banquet (2012).

BUILDING OFFICIALS ASSOCIATION OF FLORIDA, Lake Mary, FL 2009 – June 2012

Contract Instructor (volunteer)

Create and conduct Florida State - approved CEU classes for Building Officials, Plans Examiners, Engineers, Inspectors, and Contractors; class sizes range from 35 - 100 participants. Provide instruction at Chapter and Conference seminars throughout Florida; course topics include *Ethics in Construction*, *Photovoltaics*, and *National Electrical Code Updates*.

ELECTRICAL COUNCIL OF FLORIDA, Tampa, FL 2004 - Present

CEU Instructor/ Current Tampa Chapter President

Create and conduct Florida State - approved CEU code update classes throughout the state of Florida. Topics include: *Ethics in Construction*, *Prevention of False Alarms*, *Areas of Accessibility*, *Standby Generator Systems*, *National Electrical Code Updates*, *Laws & Rules for Construction Based on Florida Statutes*, and *Advanced Building Code Class*.

Instruct ECLB approved CEU classes to four local Chapters (4 - 6 times annually) and provide education at ECF State sponsored seminars (10 locations bi-annually); throughout the State of Florida.

- Certified through Construction Industry Licensing Board (CILB) and/or Electrical Contracting Licensing Board (ECLB) to conduct classes.

INDEPENDENT ELECTRICAL CONTRACTORS, Clearwater, FL 2006 - 2008

4th-Year Electrical Apprenticeship Instructor

Created lesson plans, quizzes, and exams.

- Lead 4th-year instructor; achieved 82% Journeymen Exam passing rate (27 students).

EDUCATION

Continuing Education Seminars and Code Update Classes through IAEI, BOAF and ECF

- *Network +* (2002); graduated in the Top 3 of Class.
- *AutoCAD for the Professional 3D Rendering*; *AutoCAD for the Professional Level I/II*; *AutoCAD 2002*
- Pinellas Vocational Technical Institute, Clearwater, FL; *Programmable Logical Controllers (1998)*
Motor Controls (1981)
- *Charles J. Krasnoff Electrical Estimating Seminar*, Tampa, FL (1993)
- Bay Area Tech, Tampa, FL; *Electrical Estimating*
- *Masters Prep Course*
- Gibbs Sr. High School, St. Petersburg, FL; Diploma/Graduated

Attachment #3: Course Materials and Fees

Course Material:

The course is reviewed online and is available to anyone who purchases it 24/7 as long as there is computer and internet access.

All material necessary to complete the course is included by viewing online. Students are not directed to additional material as a requirement for course completion, only as added information for personal interest.

Course Fee:

The fee for this course is \$44.85

Attachment #4: Schedule of Course Dates and Locations

This course is presented in an online format. The course is available at www.RedVector.com 24 hours a day, 7 days a week to anyone with computer and internet access.

SAMPLE

Certificate of Completion

John Doe

VA License #: 123456

has successfully completed the following course

2014 NEC Changes - Chapter 5 and Chapter 6 (RV-PGM103)

This online course is approved for 3 continuing education hours

XXXXXXXXXX

date of course completion

Course Approval

Course Completion Date

Matthew Casey, PhD, VP of Content

RedVector.com
AIA Registered Provider #J315
FL DBPR Approved Provider #0001771
FBPE Approved Provider #33



Two Urban Centre • 4890 West Kennedy Boulevard Suite 740 • Tampa, FL 33609

Attachment #6: Online/Correspondence Course Information

Security Procedures Utilized:

All students must register with the web site to gain access to their online course(s). The registration process creates a unique user profile and records their personal information including name, address, phone, email, username, password, licenses held, and license number(s). This information is automatically recorded and saved electronically.

We monitor required student participation in the course by logging and tracking the date and time a student enters a course, tracking activity during the course, and recording the date and time they complete the exam with a required passing score. If our learning management system detects 13-minutes of inactivity, a pop-up appears alerting the student that they must verify their presence or the session times out and the course closes.

In addition, at the completion of an exam, before it is graded, students are asked to confirm an affidavit indicating they personally completed the entire course. They must also confirm their identity before their exam is graded. This confirmation is stored in our database for audit purposes.

Once a student completes and passes the course with a grade of 70% or higher, they are given a certificate of completion and the course completion is recorded in their user profile, along with date and time completed.

End of Course Test:

A copy is attached for review.

Online Course Access:

The Board has been set up with a test account to preview courses on the RedVector.com website. To access the courses, please follow the directions below.

1. Log on to the web site at <http://www.RedVector.com>
2. On the top center of the page click the orange "Sign-In" button.
3. In the gray column labeled "Returning Users" enter your username **VAELEC** and your password **vaelec (both are case-sensitive)**. Click the "LOGIN" button.
4. You should arrive at the User Menu. Click on the second box "My Courses".
5. A list of courses will appear. Click on the title of the course you wish to begin and follow the instructions.

Final Exam: 2014 NEC Changes - Chapter 5: Special Occupancies (RV-10516)

1. **517.2** Critical Branch is a system of feeders and branch circuits supplying power for _____ serving areas and functions related to patient care and that is automatically connected to alternate power sources by one or more transfer switches during interruption of normal power source. Which item below is not correct?
 - A. Task illumination
 - B. Fixed equipment
 - C. Special power circuits
 - D. Select power circuits

2. **517.2** Equipment Branch is a system of feeders and branch circuits arranged for _____ connection to the alternate power source and that serves primarily 3-phase power equipment.
 - A. Delayed
 - B. Automatic
 - C. Manual connection
 - D. Any of the above

3. **517.2** Critical Care Space is defined as:
 - A. Space in which failure of equipment or a system is not likely to cause injury to the patients or caregivers but may cause patient discomfort.
 - B. Space in which failure of equipment or a system is likely to cause major injury or death to patients or caregivers.
 - C. Space in which failure of equipment or a system is likely to cause minor injury to patients or caregivers.
 - D. All of the above

4. **517.2** Support Space is defined as space in which failure of equipment or a system is not likely to have a physical impact on patients or caregivers.
 - A. TRUE
 - B. FALSE

5. **517.2** Patient Care Vicinity is a space, within a location intended for the examination and treatment of patients, extending _____ beyond the normal location of the patient bed, chair, table, treadmill, or other device that supports the patient during examination and treatment and extending vertically to 2.3 m (7 ft 6 in.) above the floor.
 - A. 2 ft
 - B. 4. ft
 - C. 5 ft
 - D. 6 ft

6. **517.18 (A)** Which choice below is correct? Each patient bed location shall be supplied by at least two branch circuits, one from the _____. All branch circuits from the normal system shall originate in the same panelboard.
- A. Emergency system and one from the critical branch
 - B. Critical branch and one from the normal system
 - C. Normal system and one from the emergency system
 - D. All of the above
7. **517.18 (B)**. Each patient bed location shall be provided with a minimum of _____ receptacles.
- A. Two
 - B. Three
 - C. Four
 - D. Eight
8. **517.19 (B) (1)**. The 2014 NEC increased from six to _____ the minimum number of receptacles required for critical care area patient bed locations of health care facilities.
- A. Fourteen
 - B. Twelve
 - C. Ten
 - D. Eight
9. **517.30 (B) (1)**. The 2014 NEC eliminated the term Emergency Systems from Article 517, leaving only the essential system with which separate branches?
- A. Critical
 - B. Life safety
 - C. Equipment
 - D. All of the above
10. **551.71**. The NEC now requires every recreational vehicle site equipped with a 50-ampere receptacle to also be equipped with a _____, 125-volt receptacle.
- A. 10-ampere
 - B. 20-ampere
 - C. 30-ampere
 - D. 38.3 ampere
11. **555.15** What form of conductors is now recognized as an acceptable for conductors used in marina and boating wiring systems?
- A. Aluminum
 - B. Steel
 - C. Nickel
 - D. Titanium
12. **590.4** What are the two new receptacles (amp/volt) that need to be listed as "extra duty type" under enclosures and covers installed in wet locations? (Mark the two that apply)
- A. 15- and 20- ampere

- B. 100- and 200-volt
- C. 50- and 60- ampere
- D. 125- and 250-volt

13. **514.3** The new Figure 514.3(b) illustrates classified areas adjacent to dispensers mounted on above ground storage tanks.
- A. True
 - B. False
14. **516.1** The revision of article 516 is critical to a safe working environment in and around the following. (Mark all that apply)
- A. Spray application
 - B. Dipping
 - C. Printing processes
 - D. Coating
15. **504.1** What is an assembly of interconnected intrinsically safe apparatus, associated apparatus, and interconnecting cables, in that those parts of the system that may be used in hazardous (classified) locations?
- A. safe power circuits
 - B. fixed equipment
 - C. safe assembly system
 - D. intrinsically safe system
16. **504.20** For consistency, the NEC also deleted some duplication within Article 504, such as 504.20 for _____.
- A. Wiring Methods
 - B. Critical Branch System
 - C. Select Power Circuits
 - D. Portable Systems
17. **514.3(b)** The NEC added a new Figure 514.3(b) in Article 514 and this is referenced at Table 514.3(B)(1), _____.
- A. Footnote 1
 - B. Footnote 2
 - C. Footnote 3
 - D. Footnote 4
18. **517.2** What is a space within a health care facility wherein patients are intended to be examined or treated?
- A. Critical Care Space
 - B. Patient Care Area Space
 - C. Basic Care Space
 - D. General Care Space

19. **517.2** What is a space in which failure of equipment or a system is not likely to cause injury to the patients or caregivers but may cause patient discomfort?
- A. Critical Care Space
 - B. Patient Care Area Space
 - C. Basic Care Space
 - D. General Care Space
20. **517.2** What is a space in which failure of equipment or a system is likely to cause minor injury to patients or caregivers?
- A. Critical Care Space
 - B. Patient Care Area Space
 - C. Basic Care Space
 - D. General Care Space
21. **517.2** What is a space where a procedure is performed that is normally subject to wet conditions while patients are present, including standing fluids on the floor or drenching of the work area, either of which condition is intimate to the patient or staff?
- A. Wet Procedure Location
 - B. Patient Care Vicinity
 - C. Support Space
 - D. Critical Care Space
22. **517.18 (A)** A new requirement for all receptacles or the cover plate supplied from the critical branch is to have a distinctive _____ or _____ so as to be readily identifiable.
- A. color
 - B. size
 - C. marking
 - D. input configuration
23. **517.18 (B)** Which of the following explains Category 2 of the building system categories?
- A. facility systems in which failure of such equipment or system is likely to cause major injury or death of patients or caregivers
 - B. is facility systems in which failure of such equipment is likely to cause minor injury to patients or caregivers
 - C. is facility systems in which failure of such equipment would have no impact on patient care
 - D. is facility systems in which failure of such equipment is not likely to cause injury to patients or caregivers but can cause patient discomfort
24. **517.18 (B)** Which of the following explains Category 4 of the building system categories?
- A. is facility systems in which failure of such equipment would have no impact on patient care
 - B. is facility systems in which failure of such equipment is likely to cause minor injury to patients or caregivers
 - C. covers facility systems in which failure of such equipment or system is likely to cause major injury or death of patients or caregivers
 - D. is facility systems in which failure of such equipment is not likely to cause injury to patients

or caregivers but can cause patient discomfort

25. **501.40** What was the reason for the deletion of verbiage for 501.40 regarding the requirements for simultaneous disconnection of all ungrounded conductors of multiwire branch circuits?
- A. The section was re-written to include a more comprehensive description of branch circuits
 - B. Class 1, Division 1 location for a multiwire branch circuit was changed to a Class 2 Division 2.
 - C. The section was re-written to include an in depth discussion on multiwire branch circuit types and uses.
 - D. Information is already provided at 210.4(B).

Exam: 2014 NEC Changes - Chapter 6: Electric Signs and Outline Lighting (RV-10517)

1. 600.6 (A) (1). The 2014 NEC now requires the disconnect to be located:
 - A. At the point feeder(s)
 - B. Branch circuit(s) supplying a sign
 - C. Branch circuits where an outline lighting system enters a sign enclosure or pole
 - D. Any of the above

2. According to 620.21 Wiring Methods (Elevators, Escalators, etc.) Exception, cords and cables of listed cord- and plug connected equipment shall not be required to be installed in a raceway.
 - A. TRUE
 - B. FALSE

3. 680.2 defines Storable Swimming, Wading, or Immersion Pools, or Storable/ Portable Spas and Hot Tubs as: Those that are constructed on or above the ground and are capable of holding water to a maximum depth of _____, or a pool, spa, or hot tub with nonmetallic, molded polymeric walls or inflatable fabric walls regardless of dimension.
 - A. 24 in
 - B. 42 in
 - C. 50 in
 - D. 55 in

4. According to 680.12 Maintenance Disconnecting Means, one or more means to simultaneously disconnect all ungrounded conductors shall be provided for all utilization equipment other than lighting. Each means shall be readily accessible and within sight from its equipment and shall be located at least 1.5 m (5 ft) horizontally from the inside walls of a pool, spa, fountain, or hot tub unless separated from the open water by a permanently installed barrier that provides a _____ reach path or greater.
 - A. 2 ft
 - B. 3 ft
 - C. 5 ft
 - D. 6 ft

5. 680.21 (C). The NEC now requires GFCI protection (regardless of ampacity) for all single-phase, 120-volt through 240-volt outlets supplying pool pump motors rated:
 - A. 15 amperes
 - B. 20 amperes
 - C. Regardless of Ampacity
 - D. None of the above

6. According to 680.22 (A) (1), at least one 125-volt, 15- or 20-ampere receptacle on a general-

purpose branch circuit must to be located not less than 1.83 m (6 ft) from, and not more than _____ from the inside wall of all permanently installed pools (not just dwelling unit pools).

- A. 30 ft
- B. 20 ft
- C. 25 ft
- D. 22 ft

7. 680.22 (A) (2). The 2014 NEC no longer requires receptacles that provide power for pool pump motors located between 3.0 m (10 ft) and 1.83 m (6 ft) from the pool to “employ a locking configuration.”
- A. TRUE
 - B. FALSE
8. 680.22 (B) (6). The NEC now permits specific low-voltage luminaires to be installed within _____ of the inside walls of permanently installed pools.
- A. 2 ft
 - B. 3 ft
 - C. 4 ft
 - D. 5 ft
9. 680.26 (C). Where none of the bonded parts is in direct connection with the pool water, the pool water shall be in direct contact with an approved corrosion-resistant conductive surface that exposes not less than _____ of surface area to the pool water at all times.
- A. 8 in.²
 - B. 9 in.²
 - C. 6 in.²
 - D. 5 in.²
10. 680.42 (B). The 2014 NEC no longer requires equipotential bonding of perimeter surfaces for outdoor spas and hot tubs, provided (4) specific conditions are met. Of the three conditions listed below, which one is not correct?
- A. The spa or hot tub shall be listed as a self-contained spa for aboveground use.
 - B. The spa or hot tub shall be identified as suitable for outdoor use.
 - C. The installation shall be in accordance with the manufacturer’s instructions and shall be located on or above grade.
 - D. All are incorrect
11. 680.42 (B) Bonding (4). The top rim of the spa or hot tub shall be at least 71 cm (28 in.) above all perimeter surfaces that are within _____, measured horizontally from the spa or hot tub. The height of nonconductive external steps for entry to or exit from the self-contained spa shall not be used to reduce or increase this rim height measurement.
- A. 12 in.
 - B. 24 in.
 - C. 30 in.
 - D. 50 in.

12. 680.57 (A)(B). The 2014 NEC now requires GFCI protection for _____ supplying electric signs installed within a fountain.
- A. The branch circuit
 - B. The branch feeder
 - C. Either a. or b.
 - D. Both
13. 690.2. A DC to DC Converter is a device installed in the PV source circuit or PV output circuit that can provide an output dc voltage and current at a _____ value than the input dc voltage and current.
- A. Higher
 - B. Lower
 - C. Equal
 - D. Either a. or b.
14. 690.2. A Direct Current (dc) Combiner is a device used in the PV source and PV output circuits to combine two or more dc circuit inputs and provide _____ dc circuit output.
- A. One
 - B. Two
 - C. Three
 - D. An equivalent
15. 690.5 (A) Ground-Fault Detection and Interruption states that automatically opening the grounded conductor of the faulted circuit for measurement purposes or to interrupt the ground-fault current path shall be permitted.
- A. TRUE
 - B. FALSE
16. 690.7 Maximum Voltage (F) Disconnects and Overcurrent Protection states, "where energy storage device output conductor length exceeds 1.5 m (5 ft), or where the circuits pass through a wall or partition the installation shall comply with (5) conditions." Of the following conditions, which one is incorrect?
- A. A disconnecting means and overcurrent protection shall be provided at the energy storage device end of the circuit. Fused disconnecting means or circuit breakers are acceptable.
 - B. Where fused disconnecting means are used, the "Line" terminals of the disconnecting means shall be connected toward the energy storage device terminals.
 - C. Overcurrent devices or disconnecting means shall be installed in energy storage device enclosures where explosive atmospheres can exist.
 - D. A second disconnecting means located at the connected equipment shall be installed where the disconnecting means required by (1) is not within sight of the connected equipment.
17. 690.10 Stand-Alone Systems (E) Back-fed Circuit Breakers states that plug-in type back-fed circuit breakers connected to a standalone or multimode inverter output in either stand-alone or utility-interactive systems shall be secured in accordance with 408.36(D). Circuit breakers that are marked "line" and "load" shall be back-fed.

- A. TRUE
- B. FALSE

18. 690.12. The 2014 NEC now requires that PV system circuits installed on or in buildings shall include a rapid shutdown function that controls specific conductors in accordance with 5 provisions, the first of which states that requirements for controlled conductors shall apply only to PV system conductors of more than 1.5 m (5 ft) in length inside a building, or more than _____ from a PV array.
- A. 10 ft
 - B. 6 ft
 - C. 8 ft
 - D. 5 ft
19. 690.35 (C)(4). The 2014 NEC does not require ground-fault protection for ungrounded PV systems to be listed.
- A. TRUE
 - B. FALSE
20. The 2014 NEC added a new 690.81 for listing requirements for PV wire used with systems over 600 volts but not exceeding _____.
- A. 1000 volts
 - B. 2000 volts
 - C. 1500 volts
 - D. 1200 volts
21. 690.41 What was the revision to the section on "System Grounding"?
- A. The section was formatted into list for clarity.
 - B. The addition of language that states that underground systems shall comply with 685.35.
 - C. The addition of language that gives a more compressive discussion on bipolar systems.
 - D. The section was moved to section 690.47.
22. 690.47 The 2014 NEC now requires an auxiliary grounding electrode system to be installed in accordance with _____ and _____ at all ground- and pole-mounted PV arrays and as close as practicable to roof-mounted PV arrays. (Mark all that apply)
- A. 250.51
 - B. 250.52
 - C. 250.53
 - D. 250.54
23. 690.47 The 2014 NEC added the word "Auxiliary" to the title and referenced in the text, along with a reference to 250.54, to indicate that this PV grounding electrode system is not required to be tied into the premises grounding electrode system.
- A. True
 - B. False

24. 690.81 The 2014 NEC added a new article, 690.81, for listing requirements for PV wire used with systems over 600 volts but not exceeding ____ volts.
- A. 1000
 - B. 1500
 - C. 2000
 - D. 2500
25. What was the change to Article 694 regarding small wind (turbine) electric systems?
- A. This article is no longer limited to wind (turbine) electric systems rated 100 kW and below
 - B. This article is no longer limited to wind (turbine) electric systems rated 200 kW and below
 - C. This article is no longer limited to wind (turbine) electric systems rated 300 kW and below
 - D. This article is no longer limited to wind (turbine) electric systems rated 400 kW and below



Attachment #1: Course Syllabus

Course Title:

2014 NEC Changes - Chapter 7 and Chapter 8 (RV-PGM106)

Course Hours:

3 hours

Course Instructor:

Neal Burdick

Course Description:

The 2014 NEC provides an accurate, reliable, and authoritative account of the hundreds of significant revisions in the 2014 Code.

This course provides coverage of significant changes in the 2014 National Electrical Code®. With every new edition of the NEC, some of the changes include new requirements to sections, while some of the changes include entirely new articles. Some changes are revisions to existing requirements while others are deletions to some existing requirements.

Chapter 7, which covers special conditions, is the third of the NEC chapters that deal with special topics. As we have seen, Chapters 5 and 6 cover special occupancies and special equipment respectively.

Special Condition is a situation that doesn't fall under the category of Special Occupancies or Special Equipment, but creates a need for additional measures consistent with other NEC Chapters whose aim is to ensure the safeguarding of people and property.

Chapter 8 of the NEC covers the wiring requirements for communications systems such as telephones, radio and TV antennas, satellite dishes, closed-circuit television (CCTV) and cable TV (CATV) systems, as well as network-powered and broadband-powered Communications systems.

Communications systems are not subject to the general requirements contained in Chapters 1 through 4 or the special requirements of Chapters 5 through 7, except where a Chapter 8 rule specifically refers to one of those chapters. Moreover, installations of communications equipment under the exclusive control of communications utilities located outdoors, or in building spaces used exclusively for such installations, are exempt from the NEC ARTICLE 700 Emergency Systems

NOTE: This course is formatted in 2 lessons with the exam given at the end of each lesson. Each lesson must be passed with a score of 70% or higher before being allowed to proceed to the next lesson. The lessons are listed below:

Lesson 1: 2014 NEC Changes - Chapter 7: Special Conditions

Lesson 2: 2014 NEC Changes - Chapter 8: Communications Systems

Course Objectives:

By the end of this course, you will be able to:

- Recognize that the NEC contains provisions that are considered necessary for safety; compliance therewith and proper maintenance results in an installation that is essentially free from hazard
- Identify the importance of surge protection for critical safety systems
- Summarize the wording for safety and warning labels applied to distribution equipment
- Describe the installation requirements that are needed for safe installation and operation of fire alarm systems
- Recognize that the NEC contains provisions that are considered necessary for safety. Compliance therewith and proper maintenance results in an installation that is essentially free from hazard
- Identify the requirement for safe installation of grounding for radio and television equipment antenna lead-in surge protectors
- Identify the safe voltage output guidelines for the power source of non-power-limited fire alarm circuits
- Explain the requirements for the safe installment of exposed NPBC cables

Lesson 1 Outline:

Introduction

ARTICLE 700 Emergency Systems

- 700.1 Scope & 700.8 Surge Protection
- 700.12 General Requirements
- 700.19 Multiwire Branch Circuits
- 700.24 Directly Controlled Luminaires
- 700.27 Selective Coordination

ARTICLE 702 Optional Standby Systems

- 702.1 Scope
- 702.7 Signs
- 702.12 Outdoor Generator Sets

ARTICLE 705 Interconnected Electric Power Production Sources

- 705.1 Scope & 705.12 Point of Connection

ARTICLE 708 Critical Operations Power Systems (COPS)

- 708.52 Ground-Fault Protection of Equipment

ARTICLE 725 Class 1, Class 2, and Class 3 Remote-Control, Signaling, and Power-Limited Circuits

- 725.1 Scope & 725.2 Definitions
- 725.3 Other Articles
- 725.154 Applications of Listed Class 2, Class 3, and PLTC Cables
- 725.179 Listing and Marking of Class 2, Class 3, Type PLTC Cables, and Signaling Raceways

ARTICLE 728 Fire-Resistive Cable Systems

- 728.1 Scope

ARTICLE 750 Energy Management Systems

- 750.1 Scope

ARTICLE 760 Fire Alarm Systems

- 760.1 Scope & 760.24 Mechanical Execution of Work

ARTICLE 770 Optical Fiber Cables and Raceways

- 770.110 Raceways and Cable Routing Assemblies for Optical Fiber Cables
- 770.154 Applications of Listed Optical Fiber Cables
- 770.180 Grounding Devices

Conclusion

Lesson 2 Outline:

Introduction

ARTICLE 800 Communications Circuits

- General
- 800.1 Scope
- 800.2 Definitions
- 800.12 Innerduct
- 800.179 Communications Wires and Cables
- 800.182 Communications Raceways and Cable Routing Assemblies

ARTICLE 810 Radio and Television Equipment

- General
- 810.1 Scope
- 810.6 Antenna Lead-In Protectors

ARTICLE 820 Community Antenna Television and Radio Distribution Systems

- General
- 820.1 Scope
- 820.3 Other Articles
- 820.47 Underground Coaxial Cables Entering Buildings

ARTICLE 830 Network-Powered Broadband Communications Systems

- 830.1 Scope
- 830.24 Mechanical Execution of Work

Conclusion

RedVector[®]

Online Education for Design and Construction

RECEIVED
SEP 9 2014
CONTRACTORS

2014 NEC Changes - Chapter 7: Special Conditions

Table of Contents

Introduction	4
Course Overview	4
Learning Objectives	4
ARTICLE 700 Emergency Systems	6
700.1 Scope & 700.8 Surge Protection	6
700.12 General Requirements	7
700.19 Multiwire Branch Circuits	9
700.24 Directly Controlled Luminaires	9
700.27 Selective Coordination	11
ARTICLE 702 Optional Standby Systems	12
702.1 Scope	12
702.7 Signs	12
702.12 Outdoor Generator Sets	13
ARTICLE 705 Interconnected Electric Power Production Sources	14
705.1 Scope & 705.12 Point of Connection	14
ARTICLE 708 Critical Operations Power Systems (COPS)	17
708.52 Ground-Fault Protection of Equipment	17
ARTICLE 725 Class 1, Class 2, and Class 3 Remote-Control, Signaling, and Power-Limited Circuits	18
725.1 Scope & 725.2 Definitions	18
725.3 Other Articles	19
725.154 Applications of Listed Class 2, Class 3, and PLTC Cables	21
725.179 Listing and Marking of Class 2, Class 3, Type PLTC Cables, and Signaling Raceways	24
ARTICLE 728 Fire-Resistive Cable Systems	26
728.1 Scope	26
ARTICLE 750 Energy Management Systems	28
750.1 Scope	28
ARTICLE 760 Fire Alarm Systems	31
760.1 Scope & 760.24 Mechanical Execution of Work	31
ARTICLE 770 Optical Fiber Cables and Raceways	32
770.110 Raceways and Cable Routing Assemblies for Optical Fiber Cables	32
770.154 Applications of Listed Optical Fiber Cables	34

2014 NEC Changes - Chapter 7: Special Conditions

770.180 Grounding Devices	36
Conclusion	37
Summary	37
Resources.....	38
References	38
Author Biography	39
Neal L. Burdick.....	39

Introduction

Course Overview

This is the **seventh** of several courses covering the changes in the 2014 edition of the **National Electrical Code** (NEC) created by the NFPA. The 2014 NEC provides an accurate, reliable, and authoritative account of the hundreds of significant revisions in the 2014 Code.

This course provides coverage of significant changes in the *2014 National Electrical Code*. With every new edition of the NEC, some of the changes include new requirements to sections, while some of the changes include entirely new articles. Some changes are revisions to existing requirements while others are deletions to some existing requirements.

Although not required, **it is recommended to have a copy of the 2014 NEC manual for reference**, especially when reviewing information in large tables.

A **Summary of each change** is followed by the actual NEC Language, with deletions showing with a ~~striketrough~~ and additions/changes (highlighted in yellow). When necessary, **Comments** are added to appropriate topics.

In many cases, paragraphs not directly affected by a change are retained to preserve context. *There will be no quiz questions on material that does not cover changes in the 2014 NEC.*

The length of each segment varies depending on the topic and material available.

The National Electrical Code is intended for electricians and subcontractors, electrical inspectors, electrical engineers, designers, and other qualified persons who understand electrical currents, theory, safety procedures, and electrical trade practices. The code does not serve as a teaching manual for untrained individuals.

Chapter 7, which covers special conditions, is the third of the NEC chapters that deal with special topics.

As we have seen, Chapters 5 and 6 cover special occupancies and special equipment respectively.

Special Condition is a situation that doesn't fall under the category of Special Occupancies or Special Equipment, but creates a need for additional measures consistent with other NEC Chapters whose aim is to ensure the safeguarding of people and property.

Learning Objectives

By the end of this course, you will be able to:

- Identify the various significant changes in Chapter 6 of the NEC
- Recognize that the NEC contains provisions that are considered necessary for safety; compliance therewith and proper maintenance results in an installation that is essentially free from hazard
- Refer to the appropriate sections of the code and find applicable changes
- Identify the importance of surge protection for critical safety systems

- Select the appropriate wording for revised warning signs for electrical safety
- List the energy management devices that serve to address facility and personnel safety
- Summarize the wording for safety and warning labels applied to distribution equipment
- Describe the installation requirements that are needed for safe installation and operation of fire alarm systems

ARTICLE 700 Emergency Systems

700.1 Scope & 700.8 Surge Protection

The provisions of this article apply to the electrical safety of the installation, operation, and maintenance of emergency systems consisting of circuits and equipment intended to supply, distribute, and control electricity for illumination, power, or both, to required facilities when the normal electrical supply or system is interrupted.

Informational Note No. 1: For further information regarding wiring and installation of emergency systems in health care facilities, see Article 517.

Informational Note No. 2: For further information regarding performance and maintenance of emergency systems in health care facilities, see NFPA 99-2012, Health Care Facilities Code.

Informational Note No. 3: For specification of locations where emergency lighting is considered essential to life safety, see NFPA 101-2012, Life Safety Code.

Informational Note No. 4: For further information regarding performance of emergency and standby power systems, see NFPA 110-2013, Standard for Emergency and Standby Power Systems.

700.8 Surge Protection.

The 2014 NEC now requires listed surge protective devices (SPD) for emergency systems.

NEC Language

700.8 Surge Protection (Emergency Systems)

A listed SPD shall be installed in or on all emergency systems switchboards and panelboards.

Comments

The 2011 NEC did not require surge protection devices for emergency systems.

Article 100 defines a *Surge Protective Device (SPD)* as "A protective device for limiting transient voltages by diverting or limiting surge current; it also prevents continued flow of follow current while remaining capable of repeating these functions." The Article 100 definition also lists four types of SPDs.

A spike or surge in current that goes unarrested can cause great damage to appliances and electronic equipment. This damage can be caused by the starting and stopping of power electronic equipment, direct or indirect lightning strikes, and imposition of a higher voltage on a lower voltage system.

Since buildings and infrastructures are becoming more reliant on electronic control and communication, surge protection ensures that critical safety systems are not compromised and property damage within these infrastructures become less and less common.

You may want to look up **Article 285**, which covers general requirements, installation and connection requirements for surge-protective devices (SPDs) permanently installed on premises wiring systems of 1000 volts or less.

For further information on Type 1, Type 2, Type 3, and Type 4 SPDs, see *UL 1449, Standard for Surge Protective Devices*.

700.12 General Requirements.

(F) Unit Equipment

The NEC reformatted Section 700.12(F) into a list.

For emergency systems, a separate branch circuit for unit equipment that is permitted (by exception) in a separate and uninterrupted area supplied by a minimum of three normal lighting circuits cannot be part of a multiwire branch circuit.

NEC Language

700.12 General Requirements (*Sources of Power for Emergency Systems*)

Current supply shall be such that, in the event of failure of the normal supply to, or within, the building or group of buildings concerned, emergency lighting, emergency power, or both shall be available within the time required for the application but not to exceed 10 seconds.

(Please use your copy of the 2014 NEC to review the complete text).

(F) Unit Equipment

(1) Components of Unit Equipment

Individual unit equipment for emergency illumination shall consist of the following:

- (1) A rechargeable battery
- (2) A battery charging means
- (3) Provisions for one or more lamps mounted on the equipment, or shall be permitted to have terminals for remote lamps, or both
- (4) A relaying device arranged to energize the lamps automatically upon failure of the supply to the unit equipment

(2) Installation of Unit Equipment

Unit equipment shall be installed in accordance with 700.12(F)(2)(1) through (6).

- (1) The batteries shall be of suitable rating and capacity to supply and maintain at not less than 87 ½ percent of the nominal battery voltage for the total lamp load associated with the unit for a period of at least 1 ½ hours, or the unit equipment shall supply and maintain not less than 60

percent of the initial emergency illumination for a period of at least 1 ½ hours. Storage batteries, whether of the acid or alkali type, shall be designed and constructed to meet the requirements of emergency service.

(2) Unit equipment shall be permanently fixed in place (i.e., not portable) and shall have all wiring to each unit installed in accordance with the requirements of any of the wiring methods in Chapter 3. Flexible cord-and plug connection shall be permitted, provided that the cord does not exceed 900 mm (3 ft) in length.

(3) The branch circuit feeding the unit equipment shall be the same branch circuit as that serving the normal lighting in the area and connected ahead of any local switches.

Exception No. 4: In a separate and uninterrupted area supplied by a minimum of three normal lighting circuits that are not part of a multiwire branch circuit, a separate branch circuit for unit equipment shall be permitted if it originates from the same panelboard as that of the normal lighting circuits and is provided with a lock-on feature.

(4) The branch circuit that feeds unit equipment shall be clearly identified at the distribution panel.

(5) Emergency luminaires that obtain power from a unit equipment and are not part of the unit equipment shall be wired to the unit equipment as required by 700.10 and by one of the wiring methods of Chapter 3.

(6) ~~Exception No. 2:~~ Remote heads providing lighting for the exterior of an exit door shall be permitted to be supplied by the unit equipment serving the area immediately inside the exit door.

Comments

NEC Section 700.12 covers the general requirements for sources of power for emergency systems.

Section 700.12(F) covers individual unit equipment for the emergency system.

One of the provisions for the installation of emergency unit equipment requires the branch circuit feeding this unit equipment to be on the same branch circuit as that serving the normal lighting in the area and connected ahead of any local switches.

An exception to this rule permits a separate branch circuit for unit equipment in a separate and uninterrupted area supplied by a minimum of three normal lighting circuits. This exception for a separate branch circuit can only be applied if it originates from the same panel board as that of the normal lighting circuits and is provided with a lock-on feature.

A second exception permits remote heads providing lighting for the exterior of an exit door to be supplied by the unit equipment serving the area immediately inside the exit door.

The NEC 2014 revised the exception [now 700.12(F)(2)(3), *Exception*] that permits a separate branch circuit for unit equipment in a separate and uninterrupted area supplied by a minimum of

three normal lighting circuits. The revision to this exception makes it clear that this separate branch circuit cannot be part of a multiwire branch circuit.

The previous second exception permitting remote heads providing lighting for the exterior of an exit door to be supplied by the unit equipment serving the area immediately inside the exit door has been revised into positive language and is now found at 700.12(F)(2)(6).

700.19 Multiwire Branch Circuits

The NEC now states that the branch circuit serving emergency lighting and power circuits shall not be part of a multiwire branch circuit.

NEC Language

700.19 Multiwire Branch Circuits.

The branch circuit serving emergency lighting and power circuits shall not be part of a multiwire branch circuit.

Comments

Emergency systems, circuits, and equipment are intended to supply, distribute, and control electricity for illumination, power, or both, to required facilities when the normal electrical supply or system is interrupted. For this reason, it is critical that these emergency circuits are built and maintained to supply continual and reliable power.

The provisions added at 700.19 prohibit multiwire branch circuits from serving emergency lighting and power circuits. This is similar in nature to the requirements added to 517.18(A) and 517.19(A) in the 2011 NEC.

Note that 210.4(B) requires that each multiwire branch circuit be provided with a means to simultaneously disconnect all ungrounded conductors at the point where the branch circuit originates. This new requirement and those added to Article 517 were added to prevent the unnecessary opening of all poles of a multiwire branch circuit when an overload, ground-fault, or short-circuit occurs on one pole of the multiwire branch circuit.

Emergency power and lighting circuits have the same need for continuity of service as those circuits at a health care facility.

700.24 Directly Controlled Luminaires

The 2014 NEC now requires emergency system luminaires and all external bypass controls to be individually listed for use in emergency systems.

NEC Language

700.24 Directly Controlled Luminaires

Where emergency illumination is provided by one or more directly controlled luminaires that respond to an external control input to bypass normal control upon loss of normal power, such luminaires and external bypass controls shall be individually listed for use in emergency systems.

Comments

Emergency luminaires and the external bypass controls are now required to be individually listed for use in emergency systems where emergency illumination is provided by one or more directly controlled luminaires.

These directly controlled luminaires respond to an external control input to bypass normal control upon loss of normal power.

The NEC requires emergency illumination in Article 700 to include all means of egress lighting, illuminated exit signs, and all other lights specified as necessary to provide required illumination in an emergency situation.

Emergency lighting systems are required to be designed and installed so that the failure of any individual lighting element, such as the burning out of a lamp, cannot leave in total darkness any space that requires emergency illumination.

In accordance with 700.23, a dimmer or relay system containing more than one dimmer or relay and listed for use in emergency systems is permitted to be used as a control device for energizing emergency lighting circuits.

A new class of light-emitting diode (LED) luminaire is being used in emergency lighting systems. These luminaires are typically dimmable LED luminaires that operate on constant power with an analog or digital input connected to an analog or digital control system to provide a dimming or switching function in the luminaire when normal power is present.

This luminaire will also have a separate analog or dry-closure "emergency" control input, which can be actuated by an upstream transfer switch. When this emergency input is accessed upon loss of normal power, transfer of power is switched from the luminaire's normal branch circuit to emergency power. At this point, the luminaire turns on full, regardless of the control setting of the normal control system.

These LED luminaires are currently not listed for this emergency application and may or may not have sufficient reliability or predictable performance for use in emergency systems. LED luminaires contain multifaceted electronics and just like other critical components in the emergency system, should be listed for use for emergency systems.

It should be noted that this new provision not only requires the emergency system luminaire to be listed, but the external bypass controls are required to be individually listed for use in emergency systems as well.

700.27 Selective Coordination

The 2014 NEC now requires the use of a licensed professional engineer or other qualified persons to design and select the selective coordination of the overcurrent protective devices for emergency systems.

NEC Language

700.27 Selective Coordination

Emergency system(s) overcurrent devices shall be selectively coordinated with all supply-side overcurrent protective devices.

Selective coordination shall be selected by a licensed professional engineer or other qualified persons engaged primarily in the design, installation, or maintenance of electrical systems.

The selection shall be documented and made available to those authorized to design, install, inspect, maintain, and operate the system.

Exception: Selective coordination shall not be required between two overcurrent devices located in series if no loads are connected in parallel with the downstream device.

Comments

The overcurrent devices for emergency system(s) are required to be selectively coordinated with all supply side overcurrent protective devices. An exception to this rule would exempt selective coordination between two overcurrent devices located in series if no loads are connected in parallel with the downstream device.

There is enough evidence that selective coordination is not being uniformly enforced, or is not being enforced at all. In an effort to aid in the enforcement of this essential issue with emergency systems, this new language seeks to identify who is responsible for the design and selection of the overcurrent protective devices for selective coordinated for emergency systems.

This new requirement also provides verified selective coordination documentation as part of the construction documents available to the *Authority Having Jurisdiction (AHJ)*. This design professional is the only person who has overall control of the selective coordination system at the implementation stage.

Without this new provision, the electrical switchboard or switchgear manufacturer is often relied upon to provide this selective coordination.

In most cases, the electrical switchboard or switchgear manufacturer only has control of the coordination of their own equipment. This can result in no coordination on other electrical equipment such as generators and automatic transfer switches.

Note that this new text would not prohibit the switchgear manufacturer from designing the total selective coordination as long as this person is "*a licensed professional engineer or other*

qualified person(s) engaged primarily in the design, installation, or maintenance of electrical systems."

The 2014 NEC also implemented this same new "*licensed professional engineer or other qualified persons*" selective coordination provision at the following locations:

620.62 Elevators, Escalators, (Etc.)

701.27 Optional Standby Systems

708.54 Critical Operations Power Systems (COPS)

ARTICLE 702 Optional Standby Systems

702.1 Scope

The provisions of this article apply to the installation and operation of optional standby systems.

The systems covered by this article consist of those that are permanently installed in their entirety, including prime movers, and those that are arranged for a connection to a premises wiring system from a portable alternate power supply.

702.7 Signs

(C) Power Inlet

Where an optional standby systems power inlet is used for a temporary connection to a portable generator, the 2014 NEC now requires a warning sign to be placed near the inlet to indicate the type of derived system involved (bonded neutral or floating neutral).

NEC Language

702.7 Signs

(C) Power Inlet

Where a power inlet is used for a temporary connection to a portable generator, a warning sign shall be placed near the inlet to indicate the type of derived system that the system is capable of based on the wiring of the transfer equipment. The sign shall display one of the following warnings:

<p>WARNING:</p> <p>FOR CONNECTION OF A SEPARATELY DERIVED</p> <p>(BONDED NEUTRAL) SYSTEM ONLY</p>
--

Or

WARNING:
FOR CONNECTION OF A NONSEPARATELY DERIVED
(FLOATING NEUTRAL) SYSTEM ONLY

Comments

Portable generators may or may not be part of an electrical inspection.

Depending on the type of portable generator (*bonded neutral vs. floating neutral*), it is possible to experience unsafe conditions such as paralleling grounded currents on both the equipment grounding conductor and the grounded conductor, or circulating currents on the equipment grounding conductor system.

This new warning sign requirement clearly indicates the type of required electrical connection to the portable generator inlet to achieve optimal electrical safety.

702.12 Outdoor Generator Sets

A portable generator (rated 15 kW or less) using a flanged inlet or other cord- and plug-type connection is not required to have a disconnecting means where ungrounded conductors serve or pass through a building or structure.

NEC Language

702.12 Outdoor Generator Sets

(A) Permanently Installed Generators and Portable Generators Greater Than 15 kW

Where an outdoor housed generator set is equipped with a readily accessible disconnecting means in accordance with 445.18, and the disconnecting means is located within sight of the building or structure supplied, an additional disconnecting means shall not be required where ungrounded conductors serve or pass through the building or structure. Where the generator supply conductors terminate at a disconnecting means in or on a building or structure, the disconnecting means shall meet the requirements of 225.36.

(B) Portable Generators 15 kW or Less

Where a portable generator, rated 15 kW or less, is installed using a flanged inlet or other cord- and plug-type connection, a disconnecting means shall not be required where ungrounded conductors serve or pass through a building or structure.

Comments

This NEC section for outdoor generator sets was divided into two subsections.

1. Section 702.12(A), *Permanently Installed Generators and Portable Generators Greater Than 15 kW*, incorporated the previous provisions from 702.12 of the 2011 NEC.

2. Section 702.12(B), *Portable Generators 15 kW or Less*, is new. This new subsection permits portable generators (rated 15 kW or less) using a flanged inlet or other cord- and plug-type connection to omit a disconnecting means where ungrounded conductors serve or pass through a building or structure.

This new subsection permits portable generator (rated 15 kW or less) using a flanged inlet or other cord- and plug-type connection to not require a disconnecting means where ungrounded conductors serve or pass through a building or structure.

These small portable generators (found mostly in residential applications) are often installed without a disconnecting means other than the above-mentioned flanged inlet and flexible cord. This new provision will bring the requirements for portable generators rated 15 kW or less in line with typical installation practices that are already being implemented by manufacturers and today's work force.

ARTICLE 705 Interconnected Electric Power Production Sources

705.1 Scope & 705.12 Point of Connection

This article covers installation of one or more electric power production sources operating in parallel with a primary source(s) of electricity.

Informational Note: Examples of the types of primary sources include a utility supply or an on-site electric power source(s).

705.12 Point of Connection

(D) Utility-Interactive Inverters.

Section 705.12(D) contains the provisions for utility-interactive inverters and their point of connection for an interconnected electric power source.

The 2014 NEC reorganized this section for clarity.

NEC Language

705.12 Point of Connection (Interconnected Electric Power Production Sources)

The output of an interconnected electric power source shall be connected as specified in 705.12(A), (B), (C), or (D).

(D) Utility-Interactive Inverters

The output of a utility interactive inverter shall be permitted to be connected to the load side of the service disconnecting means of the other source(s) at any distribution equipment on the premises.

Where distribution equipment, including switchgear, switchboards, or panel boards, is fed simultaneously by a primary source(s) of electricity and one or more utility interactive inverters,

and where this distribution equipment is capable of supplying multiple branch circuits or feeders, or both, the interconnecting provisions for the utility interactive inverter(s) shall comply with 705.12(D)(1) through (D)(6).

(1) Dedicated Overcurrent and Disconnect

The source interconnection of one or more inverters installed in one system shall be made at a dedicated circuit breaker or fusible disconnecting means.

(2) Bus or Conductor Ampere Rating

One hundred twenty-five percent of the inverter output circuit current shall be used in ampacity calculations for the following:

(1) Feeders

Where the inverter output connection is made to a feeder at a location other than the opposite end of the feeder from the primary source overcurrent device, that portion of the feeder on the load side of the inverter output connection shall be protected by one of the following:

(a) The feeder ampacity shall be not less than the sum of the primary source overcurrent device and 125 percent of the inverter output circuit current.

(b) An overcurrent device on the load side of the inverter connection shall be rated not greater than the ampacity of the feeder.

(2) Taps

In systems where inverter output connections are made at feeders, any taps shall be sized based on the sum of 125 percent of the inverter(s) output circuit current and the rating of the overcurrent device protecting the feeder conductors as calculated in 240.21(B).

(3) Busbars

One of the methods that follows shall be used to determine the ratings of busbars in panelboards.

(a) The sum of 125 percent of the inverter(s) output circuit current and the rating of the overcurrent device protecting the busbar shall not exceed the ampacity of the busbar.

Informational Note: This general rule assumes no limitation in the number of the loads or sources applied to Busbars or their locations.

(b) Where two sources, one a utility and the other an inverter, are located at opposite ends of a busbar that contains loads, the sum of 125 percent of the inverter(s) output circuit current and the rating of the overcurrent device protecting the busbar shall not exceed 120 percent of the ampacity of the busbar. The busbar shall be sized for the loads connected in accordance with Article 220. A permanent warning label shall be applied to the distribution equipment adjacent to the back-fed breaker from the inverter that displays the following or equivalent wording:

WARNING:

INVERTER OUTPUT CONNECTION;

DO NOT RELOCATE THIS OVERCURRENT DEVICE.

The warning sign(s) or label (s) shall comply with 110.21(B).

(c) The sum of the ampere ratings of all overcurrent devices on panelboards, both load and supply devices, excluding the rating of the overcurrent device protecting the busbar, shall not exceed the ampacity of the busbar. The rating of the overcurrent device protecting the busbar shall not exceed the rating of the busbar. Permanent warning labels shall be applied to distribution equipment that displays the following or equivalent wording:

WARNING:

THIS EQUIPMENT FED BY MULTIPLE SOURCES.

TOTAL RATING OF ALL OVERCURRENT DEVICES,

EXCLUDING MAIN SUPPLY OVERCURRENT DEVICE,

SHALL NOT EXCEED AMPACITY OF BUSBAR.

The warning sign(s) or label (s) shall comply with 110.21(B).

(d) Connections shall be permitted on multiple-ampacity busbars or center-fed panelboards where designed under engineering supervision that includes fault studies and busbar load calculations.

(3) ~~Ground-Fault Protection.~~ [See 705.32]

(3) Marking. [Was 705.12(D)(4)]

Equipment containing overcurrent devices in circuits supplying power to a busbar or conductor supplied from multiple sources shall be marked to indicate the presence of all sources.

(4) Suitable for Backfeed. [Was 705.12(D)(5)]

Circuit breakers, if backfed, shall be suitable for such operation.

Informational Note: Fused disconnects, unless otherwise marked, are suitable for backfeeding.

(5) Fastening. [Was 705.12(D)(6)]

Listed plug-in-type circuit breakers backfed from utility-interactive inverters that are listed and identified as interactive shall be permitted to omit the additional fastener normally required by 408.36(D) for such applications.

(6) Wire Harness and Exposed Cable Arc-Fault Protection

A utility-interactive inverter(s) that has a wire harness or cable output circuit rated 240 V, 30 amperes, or less, that is not installed within an enclosed raceway, shall be provided with listed ac AFCI protection.

~~(7) Inverter Output Connection.~~

Comments

Utility-interactive inverters are an important key for the future growth of alternative energy projects. This equipment is designed to export energy back to the local utility. This makes utility-interactive inverters unusual in that they require not only the local AHJ's (*electrical inspector*) approval, but typically, the local utility company's approval as well.

This blending of electrical safety issues and utility performance concerns makes this equipment *unique from both an inspector approval and testing lab evaluation standpoint.*

This bridging of jurisdictional concerns has been incorporated into the standard used to evaluate this equipment, *UL 1741, Inverters, Converters and Controllers for Use in Independent Power Systems*, and is also evident in Article 705.

The level of electronic sophistication of a typical utility-interactive inverter is considerably high as these devices not only convert dc electricity into ac, but they also have the capability to supply their own ac energy in a form suitable for back feeding the local utility grid.

ARTICLE 708 Critical Operations Power Systems (COPS)

708.52 Ground-Fault Protection of Equipment

Informational Note: Text that is followed by a reference in brackets has been extracted from NFPA 1600-2013, Standard on Disaster/Emergency Management and Business Continuity Programs. Only editorial changes were made to the extracted text to make it consistent with this Code.

(D) Selectivity

The 2014 NEC revised Section 708.52(D) to require separation of GFP time-current characteristics to conform to manufacturer's recommendations.

NEC Language

708.52 Ground-Fault Protection of Equipment [Critical Operations Power System(COPS)]

(D) Selectivity

Ground-fault protection for operation of the service and feeder disconnecting means shall be fully selective such that the feeder device, but not the service device, shall open on ground faults on the load side of the feeder device. ~~A six-cycle minimum separation between the service and feeder ground-fault tripping bands shall be provided.~~

~~Operating time of the disconnecting devices shall be considered in selecting the time spread between these two bands.~~

Separation of ground-fault protection time-current characteristics shall conform to manufacturer's recommendations and shall consider all required tolerances and disconnect operating time to achieve 100 percent selectivity.

Informational Note: See 230.95, Informational Note No. 4, for transfer of alternate source where ground-fault protection is applied.

Comments

The 2014 NEC revised 708.52(D) for selectivity of ground-fault protection (GFP) for operation with critical operations power systems (COPS) service and feeder disconnecting means.

This revision requires separation of GFP time-current characteristics to conform to manufacturer's recommendations.

This revision also brings 708.52(D) into alignment with 517.17(C) for *ground-fault protection (GFP)* at health care facilities.

The 6-cycle separation requirement is not universally required and is a carryover from the days of electromechanical relays operating on separate switching mechanisms. In most cases today, ground-fault protection is integral to the disconnect devices upon which the ground-fault relay operates.

Manufacturer's recommended curves include all applicable tolerances and mechanical operating time.

ARTICLE 725 Class 1, Class 2, and Class 3 Remote-Control, Signaling, and Power-Limited Circuits

725.1 Scope & 725.2 Definitions

This article covers remote-control, signaling, and power-limited circuits that are not an integral part of a device or appliance.

Informational Note: The circuits described herein are characterized by usage and electrical power limitations that differentiate them from electric light and power circuits; therefore, alternative requirements to those of Chapters 1 through 4 are given with regard to minimum wire sizes, ampacity adjustment and correction factors, overcurrent protection, insulation requirements, and wiring methods and materials.

725.2 Definitions

(Class 1, Class 2, and Class 3 Remote-Control, Signaling, and Power-Limited Circuits)

Power-Limited Tray Cable (PLTC)

The 2014 NEC added a new definition for *Power-limited Tray Cable (PLTC)*.

NEC Language

725.2 Definitions

(Class 1, Class 2, and Class 3 Remote-Control, Signaling, and Power-Limited Circuits)

Power-Limited Tray Cable (PLTC). A factory assembly of two or more insulated conductors rated at 300 volts, with or without associated bare or insulated equipment grounding conductors, under a nonmetallic jacket.

Comments

Power-limited tray cables (PLTC) are commonly used in power-limited circuits and for applications such as in the mass transit industry.

Other common applications include: burglar alarms, computer interconnects, business machines, intercom systems, and cash registers.

Unshielded PLTC cable is a power limited control cable rated at 300 volts with the option of 2 or 3 conductors per cable. These unshielded cables are typically manufactured in sizes 22 AWG through 12 AWG. PLTC cable typically has PVC insulation on the conductors and PVC gray outer sheathing. The outer sheathing has a sunlight-resistant jacket to protect it when used outdoors.

725.3 Other Articles

(K) Installation of Conductors with Other Systems

(L) Corrosive, Damp, or Wet Locations

The 2014 NEC added two new conditions to "Other Articles" applying to Class 1, Class 2, and Class 3 remote-control, signaling, and power-limited circuits.

NEC Language

725.3 Other Articles. (Class 1, Class 2, and Class 3 Remote-Control, Signaling, and Power-Limited Circuits)

Circuits and equipment shall comply with the articles or sections listed in 725.3(A) through ~~(J)~~ (L). Only those sections of Article 300 referenced in this article shall apply to Class 1, Class 2, and Class 3 circuits.

(A) Number and Size of Conductors in Raceway.

(B) Spread of Fire or Products of Combustion.

(C) Ducts, Plenums, and Other Air-Handling Spaces.

(D) Hazardous (Classified) Locations.

(E) Cable Trays.

(F) Motor Control Circuits.

(G) Instrumentation Tray Cable.

(H) Raceways Exposed to Different Temperatures.

(I) Vertical Support for Fire-Rated Cables and Conductors.

(J) Bushing.

(K) Installation of Conductors with Other Systems

Installations shall comply with 300.8.

(L) Corrosive, Damp, or Wet Locations

Class 2 and Class 3 cables, installed in corrosive, damp, or wet locations, shall comply with the applicable requirements in 110.11, 300.5(B), 300.6, 300.9, and 310.10(G).

(Please use your copy of the 2014 NEC to review the complete text).

Comments

The addition of Subsection (K) for "*Installation of Conductors with Other Systems*" gives a Code reference of 300.8. This Code reference is intended to assure that cables installed in compliance of Article 725 in raceways or cable trays will not be run with any pipe, tube, or equal for steam, water, air, gas, drainage, or any service other than electrical.

The addition of Subsection (L) for "*Corrosive, Damp, or Wet Locations*" requires compliance with 110.11; 300.5(B); 300.6; 300.9; and 310.10(G).

Section 110.11 addresses conductors or equipment required to be identified for the application where exposed to gases, fumes, vapors, liquids, or other agents that have a deteriorating effect on the conductors or equipment.

Section 300.5(G) declares the interior of enclosures or raceways installed underground to be a wet location.

Section 300.6 requires raceways, cable trays, boxes, etc., to be of materials suitable for the environment in which they are to be installed (protection against corrosion and deterioration).

Section 300.9 stipulates that the interior of raceways are to be considered a wet location where raceways are installed in wet locations above grade.

Section 310.10(G) requires conductors exposed to oils, greases, vapors, gases, fumes, liquids, or other substances having a deleterious effect on the conductor or insulation to be of a type suitable for the application.

The new 725.3(L) will assure that Class 2, and Class 3 circuits installed in corrosive, damp, and wet locations are identified for these conditions. These two new subsections were necessary to insure safe and compliant applications where Class 1, Class 2, and Class 3 cables and conductors are installed in any of the referenced conditions.

725.154 Applications of Listed Class 2, Class 3, and PLTC Cables.

Table 725.154

The 2014 NEC revised Section 725.154 and subsections and references a new Table 725.154 entitled "*Applications of Listed Class 2, Class 3 and PLTC Cables in Buildings.*"

Due to the size of this Table, you will need to review it in your copy of the NEC.

2014 NEC Changes - Chapter 7: Special Conditions

Table 725.154 Applications of Listed Class 2, Class 3, and PLTC Cables in Buildings

Applications		Wire and Cable Type					
		CL2P & CL3P	CL2R & CL3R	CL2 & CL3	CL2X & CL3X	CMUC	PLTC
In fabricated ducts as described in 300.22(B)	In fabricated ducts	Y*	N	N	N	N	N
	In metal raceway that complies with 300.22(B)	Y*	Y*	Y*	Y*	N	Y*
In other spaces used for environmental air as described in 300.22(C)	In other spaces used for environmental air	Y*	N	N	N	N	N
	In metal raceway that complies with 300.22(C)	Y*	Y*	Y*	Y*	N	Y*
	In plenum communications raceways	Y*	N	N	N	N	N
	In plenum cable routing assemblies	NOT PERMITTED					
	Supported by open metal cable trays	Y*	N	N	N	N	N
	Supported by solid bottom metal cable trays with solid metal covers	Y*	Y*	Y*	Y*	N	N
In risers	In vertical runs	Y*	Y*	N	N	N	N
	In metal raceways	Y*	Y*	Y*	Y*	N	Y*
	In fireproof shafts	Y*	Y*	Y*	Y*	N	Y*
	In plenum communications raceways	Y*	Y*	N	N	N	N
	In plenum cable routing assemblies	Y*	Y*	N	N	N	N
	In riser communications raceways	Y*	Y*	N	N	N	N
	In riser cable routing assemblies	Y*	Y*	N	N	N	N
	In one- and two-family dwellings	Y*	Y*	Y*	Y*	N	Y*

Source: NEC 2014

Table 725.154 *Continued*

Applications		Wire and Cable Type					
		CL2P & CL3P	CL2R & CL3R	CL2 & CL3	CL2X & CL3X	CMUC	PLTC
Within buildings in other than air-handling spaces and risers	General	Y*	Y*	Y*	Y*	N	Y*
	In one- and two-family dwellings	Y*	Y*	Y*	Y*	Y*	Y*
	In multifamily dwellings	Y*	Y*	Y*	Y*	Y*	Y*
	In nonconcealed spaces	Y*	Y*	Y*	Y*	Y*	Y*
	Supported by cable trays	Y*	Y*	Y*	N	N	Y*
	Under carpet	N	N	N	N	Y*	N
	In cross-connect arrays	Y*	Y*	Y*	N	N	Y*
	In any raceway recognized in Chapter 3	Y*	Y*	Y*	Y*	N	Y*
	In plenum communications raceways	Y*	Y*	Y*	N	N	Y*
	In plenum cable routing assemblies	Y*	Y*	Y*	N	N	Y*
	In riser communications raceways	Y*	Y*	Y*	N	N	Y*
	In riser cable routing assemblies	Y*	Y*	Y*	N	N	Y*
	In general-purpose communications raceways	Y*	Y*	Y*	N	N	Y*
In general-purpose cable routing assemblies	Y*	Y*	Y*	N	N	Y*	

Note: An "N" in the table indicates that the cable type shall not be permitted to be installed in the application. A "Y*" indicates that the cable shall be permitted to be installed in the application, subject to the limitations described in 725.130 through 725.143.

Source: NEC 2014

NEC Language

725.154 Applications of Listed Class 2, Class 3, and PLTC Cables.

Class 2, Class 3, and PLTC cables shall comply with any of the requirements described in 725.154(A) through (I) (C) and as indicated in Table 725.154.

(A) Plenums. [Now 725.135(B) and (C)]

(B) Risers. [Now 725.135(D), (F), and (G)]

(C) Cable Trays. [Now 725.135(H)]

(D) Industrial Establishments. [Now 725.135(J)]

~~(E) Other Wiring Within Building.~~ [Now 725.135(K), (L), and (M)]

~~(F) Cross-Connect Arrays.~~ [Now 725.135(I)]

~~(G) (A) Class 2 and Class 3 Cable Substitutions.~~

~~(H) (B) Class 2, Class 3, PLTC Circuit Integrity (CI) Cable or Electrical Circuit Protective System.~~

~~(I) (C) Thermocouple Circuits.~~

(Please use your copy of the 2014 NEC to review the complete text.)

Comments

This new table 725.152 clearly identifies the permitted and prohibited applications for Class 2, Class 3, and PLTC cables.

The previous text only stated the permitted applications and left open to interpretation whether an application is prohibited or simply overlooked.

The prohibited applications for Class 2 and Class 3 cables correlate with the prohibited applications of communications cables in Table 800.154(a).

This revision at 725.154 makes the application requirements for Class 2, Class 3, and PLTC cables consistent with application rules in Articles 770, 800, 820 and 830.

725.179 Listing and Marking of Class 2, Class 3, Type PLTC Cables, and Signaling Raceways

(F) Circuit Integrity (CI) Cable or Electrical Circuit Protective System

The 2014 NEC split Section 725.179(F) into two list items for establishing cable survivability.

Cables are tested either as CI cables or as part of an electrical circuit protective system.

NEC Language

725.179 Listing and Marking of Class 2, Class 3, Type PLTC Cables, and Signaling Raceways.

Class 2, Class 3, and Type PLTC cables, nonmetallic signaling communications raceways, and cable routing assemblies installed as wiring methods within buildings shall be listed as being resistant to the spread of fire and other criteria in accordance with 725.179(A) through ~~(K)~~ (I) and shall be marked in accordance with 725.179~~(L)~~(I).

(F) Circuit Integrity (CI) Cable or Electrical Circuit Protective System

Cables that are used for survivability of critical circuits under fire conditions shall ~~be listed as circuit-integrity (CI) cable~~ meet either 725.179(F)(1) or (F)(2) as follows:

(1) Circuit Integrity (CI) Cables.

Circuit Integrity (CI) cables, specified in 725.154(A), (B), (D)(1), and (E), and used for survivability of critical circuits, shall have the additional classification using the suffix "-CI."

Circuit integrity (CI) cables shall only be permitted to be installed in a raceway where specifically listed and marked as ~~that are~~ part of a ~~listed~~ an electrical circuit protective system as covered in 725.179(F)(2) ~~shall be considered to meet the requirements of survivability.~~

(2) Electrical Circuit Protective System

Cables specified in 725.154(A), (B), (D)(1), (E), and (F)(1) that are part of an electrical circuit protective system shall be identified with the protective system number and hourly rating printed on the outer jacket of the cable and installed in accordance with the listing of the protective system.

Informational Note No. 1: One method of defining circuit integrity (CI) cable or an electrical circuit protective system is by establishing a minimum 2-hour fire-resistance resistive rating when tested in accordance with UL 2196-2012, Standard for Tests of Fire Resistive Cables.

Informational Note No. 2: UL guide information for electrical circuit protective systems (FHIT) contains information on proper installation requirements to maintain the fire rating.

Comments

725.179(F) describes two methods of establishing cable survivability for Class 2, Class 3, and Type PLTC cables.

The 2014 NEC separated the requirements for each method into two list items. These two methods are:

1. Circuit integrity (CI) cables and
2. Electrical circuit protective systems

Circuit integrity (CI) cables are defined at 725.2 as "*Cable(s) used for remote-control, signaling, or power-limited systems that supply critical circuits to ensure survivability for continued circuit operation for a specified time under fire conditions.*"

Electrical circuit protective systems are defined at both 770.2 and 800.2 as "*A system consisting of components and materials intended for installation as protection for specific electrical wiring systems with respect to the disruption of electrical circuit integrity upon exterior fire exposure.*"

These survivability cables are tested and identified as either circuit integrity (CI) cable, or are tested and identified as part of an electrical circuit protective system.

The *UL Guide Information (White Book)*, under the category code (FHIT) *Electrical Circuit Protective Systems* states that "CI cable is tested on steel rings to simulate installation in free

air. If CI cable is intended to be installed in a raceway it is so tested. CI cable that has been tested in a raceway will be specified in the system.”

The FHIT category covers *Electrical Circuit Protective Systems* consisting of components and materials intended for installation as protection for specific electrical wiring systems, with respect to the disruption of electrical circuit integrity upon external fire exposure. This category deals with systems designed to maintain circuit integrity under fire conditions.

The new text at the two separate list items clarifies the two cable options and marking separate requirements for same. Similar changes occurred at 760.179(G) for fire alarm systems.

ARTICLE 728 Fire-Resistive Cable Systems

728.1 Scope

This article covers the installation of fire resistive cables, fire-resistive conductors, and other system components used for survivability of critical circuits to ensure continued operation during a specified time under fire conditions as required in this Code.

The 2014 NEC added a new article entitled “*Fire-Resistive Cable Systems*” to address installations of fire-resistive cables.

NEC Language

Article 728 Fire-Resistive Cable Systems

728.1 Scope

728.2 Definition

Fire-Resistive Cable System. A cable and components used to ensure survivability of critical circuits for a specified time under fire conditions.

728.3 Other Articles

Wherever the requirements of other articles of this Code and Article 728 differ, the requirements of Article 728 shall apply.

728.4 General

Fire-resistive cables, fire-resistive conductors, and components shall be tested and listed as a complete system, shall be designated for use in a specific fire rated system, and shall not be interchangeable between systems. Fire-resistive cables, conductors, and components shall be approved.

Informational Note No. 1: One method of defining the fire rating is by testing the system in accordance with UL 2196-2012, Standard for Tests of Fire Resistive Cables.

Informational Note No. 2: Fire-resistive cable systems are considered part of an electrical circuit protective system.

728.5 Installations

Fire-resistive cable systems installed outside the fire-rated rooms that they serve, such as the electrical room or the fire pump room, shall comply with the requirements of 728.5(A) through (H) and all other installation instructions provided in the listing.

(A) Mounting

The fire-resistive cable system shall be secured to the building structure in accordance with the listing and the manufacturer's installation instructions.

(B) Supports

The fire-resistive system shall be supported in accordance with the listing and the manufacturer's installation instructions.

Informational Note: The supports are critical for survivability of the system. Each system has its specific support requirements.

(C) Raceways and Couplings

Where the fire-resistive system is listed to be installed in a raceway, the raceways enclosing the system, any couplings, and connectors shall be listed as part of the fire-rated system.

(D) Cable Tray

Cable trays used as part of a fire-resistive system shall be listed as part of the fire-resistive system.

(E) Boxes

Boxes or enclosures used as part of a fire resistive system shall be listed as part of the fire-resistive system and shall be secured to the building structure independently of the raceways or cables listed in the system.

(F) Pulling Lubricants

Fire-resistive cable systems installed in a raceway shall only use pulling lubricants listed as part of the fire-resistive cable system.

(G) Vertical Supports

Cables and conductors installed in vertical raceways shall be supported in accordance with the listing of the fire-resistive cable system.

(H) Splices

Only splices that are part of the listing for the fire-resistive cable system shall be used. Splices shall have manufacturer's installation instructions.

728.60 Grounding

Fire-resistive systems installed in a raceway requiring an equipment grounding conductor shall use the same fire-rated cable described in the system, unless alternative equipment grounding conductors are listed with the system. Any alternative equipment grounding conductor shall be marked with the system number. The system shall specify a permissible equipment grounding conductor. If not specified, the equipment grounding conductor shall be the same as the fire-rated cable described in the system.

728.120 Marking

In addition to the marking required in 310.120, system cables and conductors shall be surface marked with the suffix "FRR" (fire-resistive rating), along with the circuit integrity duration in hours, and with the system identifier.

Comments

This new article indicates that when installing fire rated cables, there are different details. These systems must be installed in accordance with very specific materials, supports, and requirements and are critical for the survivability of life safety circuits.

Installing fire rated cables differ from other type cables. Some of these variances pertain to:

- conduit
- conduit supports
- type of couplings
- vertical supports and
- boxes and splices

This new article is intended to help the user of the Code with installation requirements for these cable systems.

In addition to the marking required in 310.120, fire-resistive cable system cables and conductors are required to be surface marked with the suffix "-FRR" (*Fire Resistive Rating*). These fire-resistive cables must also be marked with the circuit integrity duration in hours and with the system identifier.

ARTICLE 750 Energy Management Systems

750.1 Scope

This article applies to the installation and operation of energy management systems.

Informational Note: Performance provisions in other codes establish prescriptive requirements that may further restrict the requirements contained in this article.

ARTICLE 750 Energy Management Systems

The 2014 NEC added a new article, "*Energy Management Systems*," to address the types of loads permitted to be controlled through energy management systems.

NEC Language

Article 750 Energy Management Systems

750.1 Scope

750.2 Definitions

For the purpose of this article, the following definitions shall apply.

Control. The predetermined process of connecting, disconnecting, increasing, or reducing electric power.

Energy Management System. A system consisting of any of the following: a monitor(s), communications equipment, a controller(s), a timer(s), or other device(s) that monitors and /or controls an electrical load or a power production or storage source.

Monitor. An electrical or electronic means to observe, record, or detect the operation or condition of the electric power system or apparatus.

750.20 Alternate Power Sources

An energy management system shall not override any control necessary to ensure continuity of an alternate power source for the following:

- (1) Fire pumps
- (2) Health care facilities
- (3) Emergency systems
- (4) Legally required standby systems
- (5) Critical operations power systems

750.30 Load Management

Energy management systems shall be permitted to monitor and control electrical loads unless restricted in accordance with 750.30(A) through (C).

(A) Load Shedding Controls

An energy management system shall not override the load shedding controls put in place to ensure the minimum electrical capacity for the following:

- (1) Fire pumps
- (2) Emergency systems
- (3) Legally required standby systems
- (4) Critical operations power systems

(B) Disconnection of Power

An energy management system shall not be permitted to cause disconnection of power to the following:

- (1) Elevators, escalators, moving walks, or stairway lift chairs
- (2) Positive mechanical ventilation for hazardous (classified) locations
- (3) Ventilation used to exhaust hazardous gas or reclassify an area
- (4) Circuits supplying emergency lighting
- (5) Essential electrical systems in health care facilities

(C) Capacity of Branch Circuit, Feeder, or Service

An energy management system shall not cause a branch circuit, feeder, or service to be overloaded at any time.

750.50 Field Markings

Where an energy management system is employed to control electrical power through the use of a remote means, a directory identifying the controlled device(s) and circuit(s) shall be posted on the enclosure of the controller, disconnect, or branch-circuit overcurrent device.

Informational Note: The use of the term remote is intended to convey that a controller can be operated via another means or location through communications without a direct operator interface with the controlled device.

Comments

The new article 750 includes definitions, requirements for alternative-power sources, load-management provisions and field-marking requirements.

The article provides a good basis for inclusion of general requirements to address the types of loads permitted to be controlled through energy management.

Energy management has become commonplace in today's electrical infrastructure through the control of utilization equipment, energy storage, and power production.

Installation codes currently establish requirements for utilization equipment, energy storage, and power production that serve to address facility and personnel safety.

However, limited consideration has been given in installation codes to actively managing these systems as a means to reduce energy cost or to support peak power needs for a much broader electrical infrastructure demand.

An important aspect to consider in regards to an energy management system is to make sure an overall energy management system does not override a system specific to addressing load shedding for an alternate power source for such things as fire pumps and emergency systems.

ARTICLE 760 Fire Alarm Systems

760.1 Scope & 760.24 Mechanical Execution of Work

This article covers the installation of wiring and equipment of fire alarm systems including all circuits controlled and powered by the fire alarm system.

Informational Note No. 1: Fire alarm systems include fire detection and alarm notification, guard's tour, sprinkler water flow, and sprinkler supervisory systems. Circuits controlled and powered by the fire alarm system include circuits for the control of building systems safety functions, elevator capture, elevator shutdown, door release, smoke doors and damper control, fire doors and damper control and fan shutdown, but only where these circuits are powered by and controlled by the fire alarm system. For further information on the installation and monitoring for integrity requirements for fire alarm systems, refer to the NFPA 72-2013, National Fire Alarm and Signaling Code.

Informational Note No. 2: Class 1, 2, and 3 circuits are defined in Article 725.

760.24 Mechanical Execution of Work

The 2014 NEC divided into two subsections "*Mechanical Execution of Work*" requirements for fire alarm systems and added requirements for circuit integrity (CI) cables.

NEC Language

760.24 Mechanical Execution of Work

(A) General

Fire alarm circuits shall be installed in a neat workmanlike manner. Cables and conductors installed exposed on the surface of ceilings and sidewalls shall be supported by the building structure in such a manner that the cable will not be damaged by normal building use.

Such cables shall be supported by straps, staples, cable ties, hangers, or similar fittings designed and installed so as not to damage the cable. The installation shall also comply with 300.4(D).

(B) Circuit Integrity (CI) Cable.

Circuit integrity (CI) cables shall be supported at a distance not exceeding 610 mm (24 in.). Where located within 2.1 m (7 ft) of the floor, as covered in 760.53(A)(1) and 760.130(B)(1), as applicable, the cable shall be fastened in an approved manner at intervals of not more than 450 mm (18 in.). Cable supports and fasteners shall be steel.

Comments

Fire alarm cables and conductors installed exposed on the surface of ceilings and sidewalls are required to be supported by the building structure in such a manner that the cable(s) will not be damaged by normal building use.

These cables must also be supported by straps, staples, cable ties, hangers, or similar fittings designed and installed so as not to damage the cable.

The installation of these cables must also comply with 300.4(D) for cables and raceways installed parallel to framing members (metal nail protectors).

ARTICLE 770 Optical Fiber Cables and Raceways

770.110 Raceways and Cable Routing Assemblies for Optical Fiber Cables

Informational Note: The general term grounding conductor as previously used in this article is replaced by either the term bonding conductor or the term grounding electrode conductor (GEC), where applicable, to more accurately reflect the application and function of the conductor.

See **Informational Note** Figure 800(a) and **Informational Note** Figure 800(b) for illustrative application of a bonding conductor or grounding electrode conductor.

The 2014 NEC revised the title of 770.110 to "*Raceways and Cable Routing Assemblies for Optical Fiber Cables.*" It also added a new 770.110(C) to include provisions for "*Cable Routing Assemblies.*"

NEC Language

770.110 Raceways and Cable Routing Assemblies for Optical Fiber Cables.

(A) Types of Raceways

Optical fiber cables shall be permitted to be installed in any raceway that complies with either 770.110(A)(1) or (A)(2) and in cable routing assemblies installed in compliance with 770.110(C).

(1) Raceways Recognized in Chapter 3

Optical fiber cables shall be permitted to be installed in any raceway included in Chapter 3. The raceways shall be installed in accordance with the requirements of Chapter 3.

(2) Communications ~~Other Permitted~~ Raceways

Optical fiber cables shall be permitted to be installed in listed plenum communications raceways, listed riser communications raceways, and listed general-purpose communications raceways selected in accordance with the provisions of 770.113, 800.110, and 800.113, and installed in accordance with 362.24 through 362.56, where the requirements applicable to electrical nonmetallic tubing (ENT) apply.

(B) Raceway Fill for Optical Fiber Cables

Raceway fill for optical fiber cables shall comply with either 770.110(B)(1) or (B)(2).

(1) Without Electric Light or Power Conductors

Where optical fiber cables are installed in raceway without electric light or power conductors, the raceway fill requirements of Chapters 3 and 9 shall not apply.

(2) Nonconductive Optical Fiber Cables with Electric Light or Power Conductors

Where nonconductive optical fiber cables are installed with electric light or power conductors in a raceway, the raceway fill requirements of Chapters 3 and 9 shall apply.

(C) Cable Routing Assemblies

Optical fiber cables shall be permitted to be installed in plenum cable routing assemblies, riser cable routing assemblies, and general-purpose cable routing assemblies selected in accordance with the provisions of 800.113 and Table 800.154(c) and installed in accordance with 770.110(C)(1) and (C)(2).

(1) Horizontal Support

Cable routing assemblies shall be supported where run horizontally at intervals not to exceed 900 mm (3 ft), and at each end or joint, unless listed for other support intervals. In no case shall the distance between supports exceed 3 m (10 ft).

(2) Vertical Support

Vertical runs of cable routing assemblies shall be supported at intervals not exceeding 1.2 m (4 ft), unless listed for other support intervals, and shall not have more than one joint between supports.

Comments

The new provisions added at 770.110(C) for "*Cable Routing Assemblies*" makes it clear that optical fiber cables are permitted to be installed in plenum cable routing assemblies, riser cable routing assemblies, and general-purpose cable routing assemblies.

The NEC addresses several types of raceways in Chapters 7 and 8 such as:

- optical fiber raceways

- communication raceways, and
- CATV raceways

These raceways are actually identical raceways with different markings.

This simplifies the types of raceways specified in Articles 770, 800 and 820.

Another change at 770.110 was the addition of Subsection (C) to include provisions for "*Cable Routing Assemblies*."

A revised definition was relocated to Article 100 for cable routing assemblies, which is defined as "*A single channel or connected multiple channels, as well as associated fittings, forming a structural system that is used to support and route communications wires and cables, optical fiber cables, data cables associated with information technology and communications equipment, Class 2 and Class 3 cables, and power-limited fire alarm cables.*"

The term cable routing assemblies was introduced in the 2011 NEC at 770.2 with installation rules described at 770.113; 800.113; 820.113; and 830.113. These installation rules at 770.113 have been removed from that section and inserted at 770.110(C).

In order to separate the installation rules for optical fiber cables from the installation rules from raceways for optical fiber cables, the rules for raceways for optical fiber cables were expanded to include cable routing assemblies.

770.154 Applications of Listed Optical Fiber Cables

Table 770.154(a)

The 2014 NEC revised 770.154 and Table 770.154(a) to delete references to raceways and cable routing assemblies.

NEC Language

770.154 Applications of Listed Optical Fiber Cables ~~and Raceways, and Cable Routing Assemblies.~~

Permitted and nonpermitted applications of listed optical fiber cables ~~and raceways, and cable routing assembly types~~ shall be as indicated in Table 770.154(a) ~~on the following page~~. The permitted applications shall be subject to the installation requirements of 770.110 and 770.113.

The substitutions for optical fiber cables in Table 770.154(b) and illustrated in Figure 770.154 shall be permitted.

Table 770.154(a) Applications of Listed Optical Fiber Cables ~~and Raceways, and Cable Routing Assemblies~~ in Buildings

Table 770.154(a) Applications of Listed Optical Fiber Cables in Buildings

Applications		Cable Type		
		OFNP, OFCP	OFNR, OFCR	OFNG, OFCG, OFN, OFC
In specially fabricated ducts as described in 770.113(B)	In fabricated ducts	Y*	N	N
	In metal raceways that comply with 301.23(B)	Y*	Y*	Y*
In other spaces used for environmental air as described in 301.23(C)	In other spaces used for environmental air	Y*	N	N
	In metal raceway that complies with 301.23(C)	Y*	Y*	Y*
	In plenum communications raceways	Y*	N	N
	In plenum cable routing assemblies	NOT PERMITTED		
	Supported by open metal cable trays	Y*	N	N
	Supported by solid bottom metal cable trays with solid metal covers	Y*	Y*	Y*
	In risers	Y*	Y*	N
In risers	In vertical risers	Y*	Y*	N
	In metal raceways	Y*	Y*	Y*
	In integral shafts	Y*	Y*	Y*
	In plenum communications raceways	Y*	Y*	N
	In plenum cable routing assemblies	Y*	Y*	N
	In riser communications raceways	Y*	Y*	N
	In riser cable routing assemblies	Y*	Y*	N
	In one- and two-family dwellings	Y*	Y*	Y*
Within buildings in other than air handling spaces and risers	General	Y*	Y*	Y*
	Supported by cable trays	Y*	Y*	Y*
	In distributing frames and cross-connect arrays	Y*	Y*	Y*
	In any raceway recognized in Chapter 3	Y*	Y*	Y*
	In plenum communications raceways	Y*	Y*	Y*
	In plenum cable routing assemblies	Y*	Y*	Y*
	In riser communications raceways	Y*	Y*	Y*
	In riser cable routing assemblies	Y*	Y*	Y*
	In general-purpose communications raceways	Y*	Y*	Y*
	In general-purpose cable routing assemblies	Y*	Y*	Y*

Note: An "N" in the table indicates that the cable type shall not be permitted to be installed in the application. A "Y*" indicates that the cable shall be permitted to be installed in the application subject to the limitations described in 770.113 and 770.115.
 Informational Note No. 1: Part V of Article 770 covers installation methods within buildings. This table covers the applications of listed optical fiber cables and raceways and cable routing assemblies in buildings. The definition of Point of Entrance is in 770.2. Optical fiber entrance cables that have not emerged from the rigid metal conduit (RMC) or intermediate metal conduit (IMC) are not considered to be in the building.
 Informational Note No. 2: For information on the restrictions to the installation of optical fiber cables in fabricated ducts, see 770.113(B).
 Informational Note No. 3: Cable routing assemblies are not addressed in NFPA 90A-2012, Standard for the Installation of Air Conditioning and Ventilation Systems.

(Please use your copy of the 2014 NEC to review the Table.)

The following are Informational Notes to Table 770.154(a).

Informational Note 1: Part V of Article 770 covers installation methods within buildings. This table covers the applications of listed optical fiber cables and raceways and cable routing assemblies in buildings. The definition of Point of Entrance is in 770.2. Optical fiber entrance cables that have not emerged from the rigid metal conduit (RMC) or intermediate metal conduit (IMC) are not considered to be in the building.

Informational Note No. 2: For information on the restrictions to the installation of optical fiber cables in fabricated ducts, see 770.113(B).

Informational Note No. 3: Cable routing assemblies are not addressed in NFPA-90A-2012, Standard for the Installation of Air Conditioning and Ventilation Systems.

Comments

The NEC removed references to optical fiber raceways, and cable routing assemblies from 770.154 and Table 770.154(a) and relocated them to other appropriate sections of Article 770.

A new *Informational Note to Table 770.154(a)* was added to indicate that cable routing assemblies are not addressed in *NFPA-90A-2012, Standard for the Installation of Air Conditioning and Ventilation Systems*.

770.180 Grounding Devices

The 2014 NEC added a new 770.180, *Grounding Devices* for listing requirements (or be part of listed equipment) for grounding devices used for optical fiber cables.

NEC Language

770.180 Grounding Devices

Where bonding or grounding is required, devices used to connect a shield, sheath, or non-current-carrying metallic members of a cable to a bonding conductor or grounding electrode conductor shall be listed or be part of listed equipment.

Comments

Although Article 770 has requirements that specify when grounding or bonding of a shield, sheath or non-current-carrying metallic members of an optical fiber cable are required, there was no requirement that the devices used for this grounding and bonding application should be listed for that purpose.

Currently listed devices and grounding devices that are part of listed equipment comply with *UL 467, Grounding and Bonding Equipment* that ensures the grounding or bonding connection meets construction and performance criteria necessary for reliable bonding and grounding.

The grounding and bonding connection would go undefined without this new listing requirement at 770.180. Without using a device listed for this application, poor connections due to questionable installation methods (e.g., wrapping the conductor around a cable sheath) can increase twofold.

Employing devices that do not have the necessary strength to maintain a solid connection, or utilizing materials unsuitable for the application can add to unsatisfactory connections as well.

This same new listing requirement (Grounding Devices) has been implemented at the following locations:

800.180 Communications Circuits

810.7 Radio and Television Equipment

820.180 Community Antenna Television and Radio Distribution Systems

2014 NEC Changes - Chapter 7: Special Conditions

830.180 Network-Powered Broadband Communications Systems

840.180 Premises-Powered Broadband Communications Systems

Conclusion

Summary

You have completed Chapter 7 of this course on *Changes in the 2014 NEC*.

Resources

References

National Fire Protection Association, Inc. Quincy, MA. *2014 National Electrical Code (NEC)*, 2013.

International Association of Electrical Inspectors, Richardson, Texas and National Fire Protection Association, Inc. Quincy, MA. *Analysis of Changes – NEC 2014*. 2013.

UL 1449, Standard for Surge Protective Devices.

UL 1741, Inverters, Converters and Controllers for Use in Independent Power Systems.

NFPA-90A-2012, Standard for the Installation of Air Conditioning and Ventilation Systems.

UL 467, Grounding and Bonding Equipment.

The designations "National Electrical Code" and "NEC" refer to NFPA 70, National Electrical Code, which is a registered trademark of the National Fire Protection Association.

Author Biography

Neal L. Burdick

Neal Burdick has over 30 years of experience and is currently a construction inspector for the City of Tampa. He is a registered instructor for the Electrical Council of Florida and is the author and instructor of a State of Florida approved Electrical Contractor's Licensing Board course.

Neal is an accomplished and exceptionally knowledgeable professional with a solid background in electrical and building inspections, as well as code compliance. He is recognized as an expert in this industry. He is an active member of IAEI, BOAF, ECF, and related industry associations. Mr. Burdick conducts training to building officials, engineers, plans examiners, inspectors, electrical contractors, and apprentices throughout the State of Florida.



2014 NEC Changes - Chapter 8: Communications Systems

Table of Contents

Course Description	3
Learning Objectives	4
ARTICLE 800 Communications Circuits.....	4
800.1 Scope & 800.3 Definitions.....	4
800.2 Definitions.....	4
800.179 Communications Wires and Cables	6
800.182 Communications Raceways and Cable Routing Assemblies.....	8
ARTICLE 810 Radio and Television Equipment.....	10
810.1 Scope & 810.6 Antenna Lead-In Protectors	10
810.1 Scope.....	10
810.6 Antenna Lead-In Protectors.....	10
ARTICLE 820 Community Antenna Television and Radio Distribution Systems.....	11
820.1 Scope & 820.3 Other Articles.....	11
820.1 Scope.....	12
820.3 Other Articles	12
820.47 Underground Coaxial Cables Entering Buildings.....	16
ARTICLE 830 Network-Powered Broadband Communications Systems.....	17
830.1 Scope & 830.24 Mechanical Execution of Work.....	17
830.1 Scope.....	17
830.24 Mechanical Execution of Work	17
Conclusion	20
Summary.....	20
Resources.....	20
References.....	20
Author Biography	20

Course Description

This is the **eighth** of several courses covering the changes in the 2014 edition of the **National Electrical Code** (NEC) created by the NFPA. The 2014 NEC provides an accurate, reliable, and authoritative account of the hundreds of significant revisions in the 2014 Code.

This Course provides coverage of significant changes in the *2014 National Electrical Code*. With every new edition of the NEC, some of the changes include new requirements to sections, while some of the changes include entirely new articles. Some changes are revisions to existing requirements while others are deletions to some existing requirements.

Although not required, it is **recommended to have a copy of the 2014 NEC manual for reference**, especially when reviewing information in large tables.

A **Summary of each change** is followed by the actual NEC Language, with deletions showing with a ~~strikethrough~~ and additions/changes (highlighted in yellow). When necessary, **Comments** are added to appropriate topics.

In many cases, paragraphs not directly affected by a change are retained to preserve context. *There will be no quiz questions on material that does not cover changes in the 2014 NEC.*

The length of each segment varies depending on the topic and material available. I use a dish towel

A final quiz at the end of the course helps demonstrate your understanding of the material.

The National Electrical Code is intended for electricians and subcontractors, electrical inspectors, electrical engineers, designers, and other qualified persons who understand electrical currents, theory, safety procedures, and electrical trade practices. The code does not serve as a teaching manual for untrained individuals.

Chapter 8 of the NEC covers the wiring requirements for communications systems such as telephones, radio and TV antennas, satellite dishes, closed-circuit television (CCTV) and cable TV (CATV) systems, as well as network-powered and broadband-powered Communications systems.

Communications systems are not subject to the general requirements contained in Chapters 1 through 4 or the special requirements of Chapters 5 through 7, except where a Chapter 8 rule specifically refers to one of those chapters. Moreover, installations of communications equipment under the exclusive control of communications utilities located outdoors, or in building spaces used exclusively for such installations, are exempt from the NEC ARTICLE 700 Emergency Systems

Learning Objectives

By the end of this course, you will be able to:

- Identify the various significant changes in Chapter 6 of the NEC
- Recognize that the NEC contains provisions that are considered necessary for safety. Compliance therewith and proper maintenance results in an installation that is essentially free from hazard
- Refer to the appropriate sections of the code and find applicable changes
- Identify the requirement for safe installation of grounding for radio and television equipment antenna lead-in surge protectors
- Identify the safe voltage output guidelines for the power source of non-power-limited fire alarm circuits
- Explain the requirements for the safe installment of exposed NPBC cables

ARTICLE 800 Communications Circuits

800.1 Scope & 800.3 Definitions

800.1 Scope

This article covers communications circuits and equipment.

Informational Note No. 1: See 90.2(B)(4) for installations of communications circuits and equipment that are not covered.

Informational Note No. 2: For further information for remote-control, signaling, and power-limited circuits, see Article 725.

Informational Note No. 3: For further information for fire alarm systems, see Article 760.

800.2 Definitions

Point of Entrance

The 2014 NEC revised the definition of *Point of Entrance* by deleting "*connected by a bonding conductor or grounding electrode in accordance with 800.100(B).*"

NEC Language

800.2 Definitions

Point of Entrance. The point within a building at which the communication wire or cable emerges from an external wall, from a concrete floor slab, or from a rigid metal conduit (Type RMC) or an intermediate metal conduit (Type IMC) ~~connected by a bonding conductor or grounding electrode in accordance with 800.100(B).~~

Comments

The NEC revised this definition to identify that the wire or cable that emerges from an external wall is indeed a "communication" wire or cable. The phrase, "connected by a bonding conductor or grounding electrode in accordance with 800.100(B)" has been removed as well.

Some users of the Code viewed the 2011 NEC definition of point of entrance as having a grounding requirement in the last part of the definition.

800.12 Innerduct 800.2 Definitions

The NEC added a new definition and new provisions; *Innerduct*.

NEC Language

800.2 Definitions

Innerduct. A nonmetallic raceway placed within a larger raceway.

800.12 Innerduct

Listed plenum communications raceway, listed riser communications raceway, and listed general purpose communications raceway selected in accordance with the provisions of Table 800.154(b) shall be permitted to be installed as innerduct in any type of listed raceway permitted in Chapter 3.

Comments

This new provision permits the different types of listed communications raceways to be installed as innerduct in any type of listed raceway permitted in Chapter 3.

Innerduct is typically manufactured from high density polyethylene (HDPE) and is intended to be placed inside of existing conduits or other innerducts. This product is designed to reduce surface contact when pulling cable. This lightweight product offers maximum flexibility, and allows for installation in small or restricted areas.

Innerduct is available in a variety of sizes with 1 in., 1¼ in., and 1½ in. sizes being most common. The standard color is orange, but it is offered in a variety of other colors.

Communications raceways are permitted to substitute for optical fiber raceways. Optical fiber raceways are permitted to be used as innerduct; but in previous editions of the Code, this permission was only given in Article 770 at 770.12. The 2014 NEC, provides this permissive text in Article 800 as well.

800.179 Communications Wires and Cables

(G) Circuit Integrity (CI) Cable or Electrical Circuit Protective System

The 2014 NEC revised 800.179(G) to now contain listing requirements for an *“Electrical Circuit Protective System.”*

The NEC also added a new definition for *electrical circuit protective system* to 800.2.

NEC Language

800.179 Communications Wires and Cables.

Communications wires and cables shall be listed in accordance with 800.179(A) through (I) and marked in accordance with Table 800.179.

Table 800.179 Cable Markings

Cable Marking	Type
CMP	Communications plenum cable
CMR	Communications riser cable
CMG	Communications general-purpose cable
CM	Communications general-purpose cable
CMX	Communications cable, limited use
CMUC	Undercarpet communications wire and cable

Informational Note: Cable types are listed in descending order of fire resistance rating.

Source: NEC 2014

(G) ~~Communications~~ Circuit Integrity (CI) Cable or Electrical Circuit Protective System

Cables ~~suitable for use in communications systems to ensure~~ that are used for survivability of critical circuits ~~during a specified time~~ under fire conditions shall be listed and meet either 800.179(G)(1) or (G)(2) as follows:

(1) Circuit Integrity (CI) Cables

Circuit integrity (CI) cables specified in 800.179(A) through (E), and used for survivability of critical circuits, shall have an additional classification using the suffix "CI." In order to maintain its listed fire rating, circuit integrity (CI) cable shall only be installed in free air.

Informational Note: One method of defining circuit integrity (CI) cable is by establishing a minimum 2-hour fire resistance rating for the cable when tested in accordance with ANSI/UL 2196-2006, Standard for Tests of Fire-Resistive Cable.

(2) Fire-Resistive Cables

Cables specified in 800.179(A) through (E) and 800.179(G)(1), that are part of an electrical circuit protective system, shall be fire-resistive cable identified with the protective system number on the product, or on the smallest unit container in which the product is packaged, and shall be installed in accordance with the listing of the protective system.

Informational Note No. 1: One method of defining an electrical circuit protective system is by establishing a minimum 2-hour fire resistance rating for the system when tested in accordance with UL Subject 1724, Outline of Investigation for Fire Tests for Electrical Circuit Protective Systems.

Informational Note No. 2: The listing organization provides information for electrical circuit protective systems (FHIT), including installation requirements for maintaining the fire rating.

800.2 provides a definition:

Electrical Circuit Protective System. A system consisting of components and materials intended for installation as protection for specific electrical wiring systems with respect to the disruption of electrical circuit integrity upon exterior fire exposure.

Comments

The 2014 NEC revised the requirements at 800.179(G) by adding requirements for electrical circuit protective systems and by adding two new list items.

Section 800.179(G)(1) now covers requirements for "*Circuit Integrity (CI) Cables.*"

In addition to an additional classification using the suffix "CI," this new provision specifies that in order to maintain its listed fire rating, circuit integrity (CI) cable shall only be installed in free air.

Section 800.179(G)(2) now addresses "*Fire-Resistive Cables.*" This provision requires circuit integrity (CI) cables that are part of an electrical circuit protective system to be fire-resistive cables identified with the protective system number and installed in accordance with the listing of the protective system.

800.182 Communications Raceways and Cable Routing Assemblies

(A) Plenum Communications Raceways and Plenum Cable Routing Assemblies

(B) Riser Communications Raceways and Riser Cable Routing Assemblies

(C) General-Purpose Communications Raceways and General-Purpose Cable Routing Assemblies

The NEC made revisions at 800.182(A), (B), and (C) as to the specific cable routing assembly discussed in each subsection.

Three *Informational Notes* have been deleted and replaced with one Informational Note.

NEC Language

800.182 Communications Raceways and Cable Routing Assemblies.

Communications raceways and cable routing assemblies shall be listed in accordance with 800.182(A) through (C).

Informational Note: For information on listing requirements for both communications raceways and cable routing assemblies, see ANSI/UL 2024-2011, Signaling, Optical Fiber and Communications Raceways and Cable Routing Assemblies.

(A) Plenum Communications Raceways and Plenum Cable Routing Assemblies

~~Plenum communications raceways and plenum cable routing assemblies listed as plenum optical fiber raceways shall be permitted for use in ducts, plenums, and other spaces used for environmental air and shall also be listed as having adequate fire-resistant and low smoke-producing characteristics.~~

Here is the cleaned up version of the above paragraph:

(A) Plenum Communications Raceways and Plenum Cable Routing Assemblies

Plenum communications raceways and plenum cable routing assemblies shall be listed as having adequate fire-resistant and low-smoke producing characteristics.

~~**Informational Note:** One method of defining that an optical fiber raceway is a low smoke producing raceway and a fire resistant raceway is that the raceway exhibits a maximum peak optical density of 0.5 or less, an average optical density of 0.15 or less, and a maximum flame spread distance of 1.52 m (5 ft) or less when tested in accordance with the plenum test in UL 2024-2004, Standard for Optical Fiber Cable Raceway.~~

(B) Riser Communications Raceways and Riser Cable Routing Assemblies

Riser communications raceways and riser cable routing assemblies shall be listed as having adequate fire-resistant characteristics capable of preventing the carrying of fire from floor to floor.

~~**Informational Note:** One method of defining fire-resistant characteristics capable of preventing the carrying of fire from floor to floor is that the raceways pass the requirements of the test for Flame Propagation (riser) in UL 2024-2004, Standard for Optical Fiber Cable Raceway, or UL 2024a-2008, Outline of Investigation for Optical Fiber Cable Routing Assemblies, as applicable.~~

(C) General-Purpose Communications Raceways and General-Purpose Cable Routing Assemblies

General-purpose communications raceways and general purpose cable routing assemblies shall be listed as being resistant to the spread of fire.

~~**Informational Note:** One method of defining resistance to the spread of fire is that the raceways pass the requirements of the Vertical Tray Flame Test (General Use) in UL 2024-2004, Standard for Optical Fiber Cable Raceway, or UL 2024a-2008, Outline of Investigation for Optical Fiber Cable Routing Assemblies, as applicable.~~

Comments

The 2011 NEC revised the title of 800.182 to include both communications raceways and cable routing assemblies, but the subsequent subsection did not properly address cable routing assemblies specifically.

All three subsections were followed by an informational note that basically referenced the same UL product standards for optical fiber raceways or optical fiber cable routing assemblies.

The 2014 NEC revised Section 800.182(A), (B), and (C) to reference the specific cable routing assembly being discussed in each subsection.

The NEC also deleted three repetitive *Informational Notes* and replaced them with a new Informational Note located in the main section as it applies to 800.180(A) (B) and (C).

ARTICLE 810 Radio and Television Equipment

810.1 Scope & 810.6 Antenna Lead-In Protectors

Informational Note: The general term grounding conductor as previously used in this article is replaced by either the term bonding conductor or the term grounding electrode conductor (GEC), where applicable, to more accurately reflect the application and function of the conductor.

810.1 Scope

This article covers antenna systems for radio and television receiving equipment, amateur and citizen band radio transmitting and receiving equipment, and certain features of transmitter safety. This article covers antennas such as wire-strung type, multi-element, vertical rod, flat, or parabolic and also covers the wiring and cabling that connect them to equipment. This article does not cover equipment and antennas used for coupling carrier current to power line conductors.

810.6 Antenna Lead-In Protectors

The 2014 NEC added listing requirements for "*Antenna Lead-In Protectors*" to Article 810.

NEC Language

810.6 Antenna Lead-In Protectors

Where an antenna lead-in surge protector is installed, it shall be listed as being suitable for limiting surges on the cable that connects the antenna to the receiver/transmitter electronics and shall be connected between the conductors and the grounded shield or other ground connection. The antenna lead-in protector shall be grounded using a bonding conductor or grounding electrode conductor installed in accordance with 810.21(F).

Informational Note: For requirements covering protectors for antenna lead-in conductors, refer to UL Subject 497E, Outline of Investigation for Protectors for Antenna Lead-In Conductors.

Let's quickly review what is in 810.21(F)

810.21 Bonding Conductors and Grounding Electrode Conductors — Receiving Stations. Bonding conductors and grounding electrode conductors shall comply with 810.21(A) through (K).

(F) Electrode. The bonding conductor or grounding electrode conductor shall be connected as required in (F)(1) through (F)(3).

(1) In Buildings or Structures with an Intersystem Bonding Termination. If the building or structure served has an intersystem bonding termination as required by 250.94, the bonding conductor shall be connected to the intersystem bonding termination.

Informational Note: See Article 100 for the definition of Intersystem Bonding Termination.

(2) In Buildings or Structures with Grounding Means. If the building or structure served has no intersystem bonding termination, the bonding conductor or grounding electrode conductor shall be connected to the nearest accessible location on the following:

- (1) The building or structure grounding electrode system as covered in 250.50
- (2) The grounded interior metal water piping systems, within 1.52 m (5 ft) from its point of entrance to the building, as covered in 250.52
- (3) The power service accessible means external to the building, as covered in 250.94
- (4) The nonflexible metallic power service raceway
- (5) The service equipment enclosure, or
- (6) The grounding electrode conductor or the grounding electrode conductor metal enclosures of the power service

A bonding device intended to provide a termination point for the bonding conductor (intersystem bonding) shall not interfere with the opening of an equipment enclosure. A bonding device shall be mounted on non-removable parts. A bonding device shall not be mounted on a door or cover even if the door or cover is non-removable.

(3) In Buildings or Structures Without an Intersystem Bonding Termination or Grounding Means. If the building or structure served has no intersystem bonding termination or grounding means as described in 810.21(F)(2), the grounding electrode conductor shall be connected to a grounding electrode as described in 250.52.

250.52 is a rather long section, so you will have to review it in your manual.

Comments

The 2014 NEC added provisions at 810.6 that require radio and television equipment antenna lead-in surge protectors (when installed) to be listed as being suitable for limiting surges on the cable that connects the antenna to the receiver/transmitter electronics. This antenna lead-in surge protector is required to be connected between the conductors and the grounded shield or other ground connection.

Grounding must be accomplished using a bonding conductor or grounding electrode conductor installed in accordance with 810.21(F) through the intersystem bonding termination (if present).

Article 810 already requires various devices that may be connected to antenna systems to be listed. This new requirement for antenna lead-in protectors is in line with those listing requirements.

ARTICLE 820 Community Antenna Television and Radio Distribution Systems

820.1 Scope & 820.3 Other Articles

Informational Note: The general term grounding conductor as previously used in this article is replaced by either the term bonding conductor or the term grounding electrode conductor (GEC), where applicable, to more accurately reflect the application and function of the conductor.

See **Informational Note Figure 800(a)** and **Informational Note Figure 800(b)** for an illustrative application of a bonding conductor or grounding electrode conductor.

820.1 Scope

This article covers coaxial cable distribution of radio frequency signals typically employed in community antenna television (CATV) systems.

Informational Note: See 90.2(B)(4) for installations of CATV and radio distribution systems that are not covered

820.3 Other Articles

The 2014 NEC added subsections for "*Wiring in Ducts for Dust, Loose Stock, or Vapor Removal*" and "*Equipment in Other Space Used for Environmental Air*" to 820.3.

NEC Language

820.3 Other Articles

Circuits and equipment shall comply with 820.3(A) through ~~(G)~~ (J).

(A) Hazardous (Classified) Locations

CATV equipment installed in a location that is classified in accordance with 500.5 and 505.5 shall comply with the applicable requirements of Chapter 5.

(B) Wiring in Ducts for Dust, Loose Stock, or Vapor Removal

The requirements of 300.22(A) shall apply.

Note:

300.22(A) states the following:

300.22(A) Ducts for Dust, Loose Stock, or Vapor Removal. No wiring systems of any type shall be installed in ducts used to transport dust, loose stock, or flammable vapors. No wiring system of any type shall be installed in any duct, or shaft containing only such ducts, used for vapor removal or for ventilation of commercial-type cooking equipment.

(C) Equipment in Other Space Used for Environmental Air

The requirements of 300.22(C)(3) shall apply.

Note:

300.22(C)(3) states the following:

300.22(C)(3) Equipment. Electrical equipment with a metal enclosure, or electrical equipment with a nonmetallic enclosure listed for use within an air-handling space and having adequate

fire-resistant and low-smoke-producing characteristics, and associated wiring material suitable for the ambient temperature shall be permitted to be installed in such other space unless prohibited elsewhere in this Code.

Informational Note: One method of defining adequate fire-resistant and low-smoke-producing characteristics for electrical equipment with a nonmetallic enclosure is in ANSI/UL 2043-2008, Fire Test for Heat and Visible Smoke Release for Discrete Products and Their Accessories Installed in Air-Handling Spaces.

Exception: Integral fan systems shall be permitted where specifically identified for use within an air-handling space.

~~(B)~~ (D) Installation and Use

The requirements of 110.3(B) shall apply.

Note:

110.3(B) states the following:

110.3 Examination, Identification, Installation, and Use of Equipment.

(B) Installation and Use. Listed or labeled equipment shall be installed and used in accordance with any instructions included in the listing or labeling.

~~(C)~~ (E) Installations of Conductive and Nonconductive Optical Fiber Cables

The requirements of Article 770 shall apply.

Note:

Article 770 states the following:

ARTICLE 770

Optical Fiber Cables and Raceways

Informational Note: The general term grounding conductor as previously used in this article is replaced by either the term bonding conductor or the term grounding electrode conductor (GEC), where applicable, to more accurately reflect the application and function of the conductor.

See **Informational Note Figure 800(a)** and **Informational Note Figure 800(b)** for illustrative application of a bonding conductor or grounding electrode conductor.

ARTICLE 800 Communications Circuits

Informational Note: The general term grounding conductor as previously used in this article is replaced by either the term bonding conductor or the term grounding electrode conductor (GEC), where applicable, to more accurately reflect the application and function of the conductor.

See **Informational Note Figure 800(a)** and **Informational Note Figure 800(b)**.

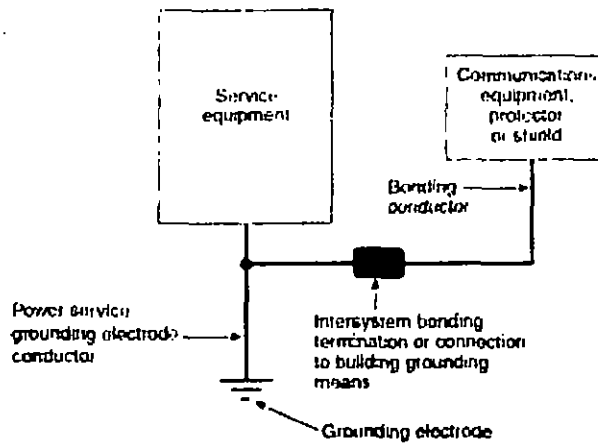

Informational Note Figure 800(a) Example of the Use of the Term *Bonding Conductor* Used In a Communications Installation.

Source: NEC 2014

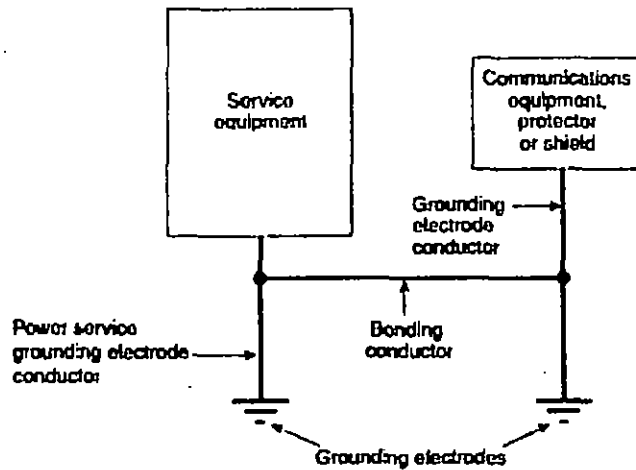

Informational Note Figure 800(b) Example of the Use of the Term *Grounding Electrode Conductor* Used In a Communications Installation.

Source: NEC 2014

(D) (F) Communications Circuits

The requirements of Article 800 shall apply.

(E) (G) Network-Powered Broadband Communications Systems

The requirements of Article 830 shall apply.

(F) (H) Premises-Powered Broadband Communications Systems

The requirements of Article 840 shall apply.

Note:

Article 840 states the following:

ARTICLE 840 Premises-Powered Broadband Communications Systems

I. General

840.1 Scope. This article covers premises-powered optical fiber-based broadband communications systems that provide any combination of voice, video, data, and interactive services through an optical network terminal (ONT).

Informational Note No. 1: A typical basic system configuration consists of an optical fiber cable to the premises (FTTP) supplying a broadband signal to an ONT that converts the broadband optical signal into component electrical signals, such as traditional telephone, video, high-speed internet, and interactive services. Powering of the ONT is typically accomplished through an ONT power supply unit (OPSU) and battery backup unit (BBU) that derive their power input from the available ac at the premises. The optical fiber cable is unpowered and may be nonconductive or conductive.

Informational Note No. 2: See 90.2(B)(4) for installations of premises-powered broadband communications systems that are not covered in this article.

You may want use your manual to review the rest of Article 840 at your convenience.

(G) (I) Alternate Wiring Methods

The wiring methods of Article 830 shall be permitted to substitute for the wiring methods of Article 820.

Informational Note: Use of Article 830 wiring methods will facilitate the upgrading of Article 820 installations to network-powered broadband applications.

(H) (J) Cable Routing Assemblies

The definition in Article 100-~~770-2~~, the applications in Table 800.154(c) ~~770-154~~, and installation requirements-~~rules~~ in 800.110 and 800.113-~~770-113~~ shall apply to Article 820.

You may want use your manual to review the material referenced above.

Comments

Besides the 2011 NEC requirements brought forward, the 2014 NEC added two new provisions to 820.3. Requirements of 300.22(A) were added for wiring in ducts for dust, loose stock, or vapor removal.

Section 300.22(A) basically states that no wiring systems of any type shall be installed in ducts used to transport dust, loose stock, or flammable vapors.

The other new provision at 820.3 added the requirements of 300.22(C)(3) for equipment in other space used for environmental air.

Section 300.22(C)(3) states that electrical equipment with a metal enclosure, or electrical equipment with a nonmetallic enclosure listed for use within an air handling space and having

low-smoke and heat release properties shall be permitted to be installed in such space unless prohibited elsewhere.

Proper Code references for cable routing assemblies were updated to coincide with changes in the 2014 NEC pertaining to cable routing assemblies.

Similar revisions with these 300.22(A) and 300.22(C)(3) references were implemented at the following locations:

770.3 Optical Fiber Cables and Raceways

800.3 Communications Circuits

830.3 Network-Powered Broadband

840.3 Premises-Powered Broadband

820.47 Underground Coaxial Cables Entering Buildings

(A) Underground Systems with Electric Light, Class 1, or Non-Power-Limited Fire Alarm Circuit Conductors

The NEC now requires underground coaxial cables to be sectioned off from electric light, power, Class 1, or "non-power-limited fire alarm" circuit conductors.

NEC Language

820.47 Underground Coaxial Cables Entering Buildings

Underground coaxial cables entering buildings shall comply with 820.47(A) and (B).

(A) Underground Systems with Electric Light, ~~and~~ Power, Class 1, or Non-Power-Limited Fire Alarm Circuit Conductors

Underground coaxial cables in a duct, pedestal, handhole enclosure, or manhole that contains electric light, ~~or~~ power, Class 1, or non-power-limited fire alarm circuit conductors shall be in a section permanently separated from such conductors by means of a suitable barrier.

(B) Direct-Buried Cables and Raceways

(The text here is unchanged. Please use your copy of the NEC to review the material).

Comments

Previous editions of the NEC required underground coaxial cables in a pedestal, handhole enclosure, etc., to be in a separate section permanently separated from exposed electric light, power, or Class 1 circuit conductors by a suitable barrier.

The 2014 NEC added "non-power-limited fire alarm circuit conductors" to the type of conductors which underground coaxial cables are required to be sectioned off from when installed in a duct, pedestal, handhole enclosure, or manhole.

Non-power-limited fire alarm circuit (NPLFA) is defined at 760.2 as, "A fire alarm circuit powered by a source that complies with 760.41 and 760.43".

Section 760.41 states that the power source of non-power-limited fire alarm circuits must comply with Chapters 1 through 4, and the output voltage cannot be more than 600 volts, nominal.

Section 760.43 states that the overcurrent protection for conductors 14 AWG and larger must be provided in accordance with the conductor ampacity without applying the ampacity adjustment and correction factors of 310.15 to the ampacity calculation.

As noted in the definition and the referenced text, NPLFA circuit conductors are capable of carrying as much or more voltage as Class 1 or power conductors.

The revisions to 820.47 fix this issue by adding NPLFA circuit conductors to the conductors required to be separated from underground coaxial cables.

ARTICLE 830 Network-Powered Broadband Communications Systems

830.1 Scope & 830.24 Mechanical Execution of Work

Informational Note: The general term grounding conductor as previously used in this article is replaced by either the term bonding conductor or the term grounding electrode conductor (GEC), where applicable, to more accurately reflect the application and function of the conductor.

See **Informational Note Figure 800(a)** and **Informational Note Figure 800(b)** for an illustrative application of a bonding conductor or grounding electrode conductor.

830.1 Scope

This article covers network-powered broadband communications systems that provide any combination of voice, audio, video, data, and interactive services through a network interface unit.

Informational Note No. 1: A typical basic system configuration includes a cable supplying power and broadband signal to a network interface unit that converts the broadband signal to the component signals. Typical cables are coaxial cable with both broadband signal and power on the center conductor, composite metallic cable with a coaxial member for the broadband signal and a twisted pair for power, and composite optical fiber cable with a pair of conductors for power. Larger systems may also include network components such as amplifiers that require network power.

Informational Note No. 2: See 90.2(B)(4) for installations of broadband communications systems that are not covered.

830.24 Mechanical Execution of Work

The NEC now requires nonmetallic cable ties and other nonmetallic cable accessories used to secure and support network-powered broadband communications cables to be listed as having low smoke and heat release properties.

NEC Language

830.24 Mechanical Execution of Work

The NEC requires network-powered broadband communications circuits and equipment to be installed in a neat and workmanlike manner. Cables installed exposed on the surface of ceilings and sidewalls shall be supported by the building structure in such a manner that the cable will not be damaged by normal building use. Such cables shall be secured by hardware including straps, staples, cable ties, hangers, or similar fittings designed and installed so as not to damage the cable. The installation shall also conform to ~~300.4(D)~~ and 300.11.

Nonmetallic cable ties and other nonmetallic cable accessories used to secure and support cables shall be listed as having low smoke and heat release properties.

Note:

It may be helpful to see here what (300.11) states:

300.11 Securing and Supporting.

(A) Secured in Place. Raceways, cable assemblies, boxes, cabinets, and fittings shall be securely fastened in place.

Support wires that do not provide secure support shall not be permitted as the sole support. Support wires and associated fittings that provide secure support and that are installed in addition to the ceiling grid support wires shall be permitted as the sole support. Where independent support wires are used, they shall be secured at both ends. Cables and raceways shall not be supported by ceiling grids.

(1) Fire-Rated Assemblies. Wiring located within the cavity of a fire-rated floor-ceiling or roof-ceiling assembly shall not be secured to, or supported by, the ceiling assembly, including the ceiling support wires. An independent means of secure support shall be provided and shall be permitted to be attached to the assembly. Where independent support wires are used, they shall be distinguishable by color, tagging, or other effective means from those that are part of the fire-rated design.

Exception: The ceiling support system shall be permitted to support wiring and equipment that have been tested as part of the fire-rated assembly.

Informational Note: One method of determining fire rating is testing in accordance with ANSI/ASTM E119-2012a, Method for Fire Tests of Building Construction and Materials.

(2) Non-Fire-Rated Assemblies. Wiring located within the cavity of a non-fire-rated floor-ceiling or roof-ceiling assembly shall not be secured to, or supported by, the ceiling assembly, including the ceiling support wires. An independent means of secure support shall be provided

and shall be permitted to be attached to the assembly. Where independent support wires are used, they shall be distinguishable by color, tagging, or other effective means.

Exception: The ceiling support system shall be permitted to support branch-circuit wiring and associated equipment where installed in accordance with the ceiling system manufacturer's instructions.

(B) Raceways Used as Means of Support. Raceways shall be used only as a means of support for other raceways, cables, or nonelectrical equipment under any of the following conditions:

- (1) Where the raceway or means of support is identified as a means of support
- (2) Where the raceway contains power supply conductors for electrically controlled equipment and is used to support Class 2 circuit conductors or cables that are solely for the purpose of connection to the equipment control circuits
- (3) Where the raceway is used to support boxes or conduit bodies in accordance with 314.23 or to support luminaires in accordance with 410.36(E)

(C) Cables Not Used as Means of Support. Cable wiring methods shall not be used as a means of support for other cables, raceways, or nonelectrical equipment.

Comments

NPBC cables installed exposed on the surface of ceilings and sidewalls are required to be supported by the building structure in such a manner that the cable will not be damaged by normal building use. Such cables are also required to be secured by hardware including straps, staples, cable ties, hangers, or similar fittings designed and installed so as not to damage the cable.

The NEC added a new last sentence added to the existing "*Mechanical Execution of Work*" requirements of 830.24. This new provision calls for nonmetallic cable ties and other nonmetallic cable accessories used to secure and support NPBC cables to be listed as having low smoke and heat release properties.

The reference to 300.4(D) was also dropped from 830.24, as 830.3(F) already includes a requirement to comply with 300.4.

The new text at 830.24 brings the NEC requirements for nonmetallic cable ties installed in spaces used for environmental air (plenums) into correlation with *NFPA 90A, Standard for the Installation of Air-Conditioning and Ventilating Systems*. This correlation will be achieved by requiring nonmetallic cable ties and other nonmetallic cable accessories used to secure and support cables in plenums to be listed as having low smoke and heat release properties.

NFPA 90A-2012 has current requirements for cable ties in ceiling cavity plenums (4.3.11.2.6.5) and raised floor plenums (4.3.11.5.5.6) that correspond to these new provisions which have been added at this subsection of the NEC.

Plenum grade nonmetallic cable ties are readily available in the marketplace today that can achieve compliance with this new provision.

Conclusion

Summary

You have completed Chapter 8 of this course on *Changes in the 2014 NEC*.

Resources

References

National Fire Protection Association, Inc. Quincy, MA. *2014 National Electrical Code (NEC)*, 2013

International Association of Electrical Inspectors, Richardson, Texas and National Fire Protection Association, Inc. Quincy, MA. *Analysis of Changes – NEC 2014*. 2013

NFPA 90A, Standard for the Installation of Air-Conditioning and Ventilating Systems

The designations "National Electrical Code" and "NEC" refer to NFPA 70, National Electrical Code, which is a registered trademark of the National Fire Protection Association.

Author Biography

Neal Burdick

Neal Burdick has over 30 years of experience and is currently a Construction Inspector for the City of Tampa. He is a registered instructor for the Electrical Council of Florida and is the author and instructor of a State of Florida approved Electrical Contractor's Licensing Board course.

Neal is an accomplished and exceptionally knowledgeable professional with a solid background in electrical and building inspections, as well as code compliance. He is recognized as an expert in this industry. He is an active member of IAEL, BOAF, ECF, and related industry associations. Mr. Burdick conducts training to Building Officials, Engineers, Plans Examiners, Inspectors, Electrical Contractors, and Apprentices throughout the state of Florida.

Attachment #2: Instructor Information

Course Instructor:

Neal Burdick

Florida Certified Electrical Contractor EC# 0002179

Mr. Burdick's resume is attached for review.

Neal L. Burdick
9840 Mainlands Blvd. West, Pinellas Park, FL 33782
Phone: 813-446-9848

PROFESSIONAL WORK HISTORY

CITY OF TAMPA, Tampa, FL 2005 – March 2013

Electrical / Construction Inspector II

Inspect all phases of electrical installations (residential, commercial, and industrial) permitted with the City of Tampa, to include underground, rough-in, and final inspections. Retrieve inspection requests, plan, and schedule, perform, and document an average of 18 to 25 field inspections daily. Verify on - site permit documentation and examine blueprints to ensure compliance with NEC and Florida Building Code requirements. Collaborate with contractors to identify and correct existing and potential deficiencies. Trained Building Inspectors on electrical segment of One / Two Family Dwelling Electrical Inspector examination; successfully tutored four Inspectors to secure their licenses.

CERTIFIED TEACHING / INSTRUCTION

PINELLAS COUNTY SCHOOL BOARD, Largo, FL 2011 - Present

Adult Education Trade Instructor (Tuesday / Thursday nights)

4th - year apprenticeship instructor for Bay Area Electrical Apprenticeship Program at Pinellas Technical Education Center (pTEC) Clearwater campus. Create lesson plans, curriculum, quizzes, and tests in preparation for the Electrical Journeyman Exam.

- Selected as keynote speaker for graduation banquet (2012).

BUILDING OFFICIALS ASSOCIATION OF FLORIDA, Lake Mary, FL 2009 – June 2012

Contract Instructor (volunteer)

Create and conduct Florida State - approved CEU classes for Building Officials, Plans Examiners, Engineers, Inspectors, and Contractors; class sizes range from 35 - 100 participants. Provide instruction at Chapter and Conference seminars throughout Florida; course topics include *Ethics in Construction*, *Photovoltaics*, and *National Electrical Code Updates*.

ELECTRICAL COUNCIL OF FLORIDA, Tampa, FL 2004 - Present

CEU Instructor/ Current Tampa Chapter President

Create and conduct Florida State - approved CEU code update classes throughout the state of Florida. Topics include: *Ethics in Construction*, *Prevention of False Alarms*, *Areas of Accessibility*, *Standby Generator Systems*, *National Electrical Code Updates*, *Laws & Rules for Construction Based on Florida Statutes*, and *Advanced Building Code Class*.

Instruct ECLB approved CEU classes to four local Chapters (4 - 6 times annually) and provide education at ECF State sponsored seminars (10 locations bi-annually); throughout the State of Florida..

- Certified through Construction Industry Licensing Board (CILB) and/or Electrical Contracting Licensing Board (ECLB) to conduct classes.

INDEPENDENT ELECTRICAL CONTRACTORS, Clearwater, FL 2006 - 2008

4th-Year Electrical Apprenticeship Instructor

Created lesson plans, quizzes, and exams.

- Lead 4th-year instructor; achieved 82% Journeymen Exam passing rate (27 students).

EDUCATION

Continuing Education Seminars and Code Update Classes through IAEI, BOAF and ECF

- *Network +* (2002); graduated in the Top 3 of Class.
- *AutoCAD for the Professional 3D Rendering*; *AutoCAD for the Professional Level I/II*; *AutoCAD 2002*
- Pinellas Vocational Technical Institute, Clearwater, FL; *Programmable Logical Controllers* (1998)
- *Motor Controls* (1981)
- *Charles J. Krasnoff Electrical Estimating Seminar*, Tampa, FL (1993)
- Bay Area Tech, Tampa, FL; *Electrical Estimating*
- *Masters Prep Course*
- Gibbs Sr. High School, St. Petersburg, FL; Diploma/Graduated

Attachment #3: Course Materials and Fees

Course Material:

The course is reviewed online and is available to anyone who purchases it 24/7 as long as there is computer and internet access.

All material necessary to complete the course is included by viewing online. Students are not directed to additional material as a requirement for course completion, only as added information for personal interest.

Course Fee:

The fee for this course is \$44.85

Attachment #4: Schedule of Course Dates and Locations

This course is presented in an online format. The course is available at www.RedVector.com 24 hours a day, 7 days a week to anyone with computer and internet access.

SAMPLE

Certificate of Completion

John Doe

VA License #: 123456

has successfully completed the following course

2014 NEC Changes - Chapter 7 & Chapter 8 (RV-PGM106)

This online course is approved for 3 continuing education hours

XXXXXXXXXX

date of course completion

Course Approval

Course Completion Date

Matthew Casey, PhD, VP of Content

RedVector.com

AIA Registered Provider #J315

FL DBPR Approved Provider #0001771

FBPE Approved Provider #33



Two Urban Centre • 4890 West Kennedy Boulevard Suite 740 • Tampa, FL 33609

Attachment #6: Online/Correspondence Course Information

Security Procedures Utilized:

All students must register with the web site to gain access to their online course(s). The registration process creates a unique user profile and records their personal information including name, address, phone, email, username, password, licenses held, and license number(s). This information is automatically recorded and saved electronically.

We monitor required student participation in the course by logging and tracking the date and time a student enters a course, tracking activity during the course, and recording the date and time they complete the exam with a required passing score. If our learning management system detects 13-minutes of inactivity, a pop-up appears alerting the student that they must verify their presence or the session times out and the course closes.

In addition, at the completion of an exam, before it is graded, students are asked to confirm an affidavit indicating they personally completed the entire course. They must also confirm their identity before their exam is graded. This confirmation is stored in our database for audit purposes.

Once a student completes and passes the course with a grade of 70% or higher, they are given a certificate of completion and the course completion is recorded in their user profile, along with date and time completed.

End of Course Test:

A copy is attached for review.

Online Course Access:

The Board has been set up with a test account to preview courses on the RedVector.com website. To access the courses, please follow the directions below.

1. Log on to the web site at <http://www.RedVector.com>
2. On the top center of the page click the orange "Sign-In" button.
3. In the gray column labeled "Returning Users" enter your username **VAELEC** and your password **vaelec (both are case-sensitive)**. Click the "LOGIN" button.
4. You should arrive at the User Menu. Click on the second box "My Courses".
5. A list of courses will appear. Click on the title of the course you wish to begin and follow the instructions.

Exam: 2014 NEC Changes - Chapter 7: Special Conditions (RV-10518)

1. 700.8 The 2014 NEC now requires listed surge protective devices (SPD) for emergency systems.
 - A. TRUE
 - B. FALSE

2. 700.12 General Requirements (Sources of Power for Emergency Systems) states that current supply shall be such that, in the event of failure of the normal supply to, or within, the building or group of buildings concerned, emergency lighting, emergency power, or both shall be available within the time required for the application but not to exceed _____.
 - A. 10 seconds
 - B. 12 seconds
 - C. 15 seconds
 - D. 20 seconds

3. 700.12(F)(1). Which of the following is/are component(s) of individual unit equipment for emergency illumination?
 - A. A rechargeable battery
 - B. A battery charging means
 - C. A relaying device arranged to energize the lamps automatically upon failure of the supply to the unit equipment
 - D. All of the above

4. 700.12(F)(2)(2). Unit equipment shall be permanently fixed in place (i.e., not portable) and shall have all wiring to each unit installed in accordance with the requirements of any of the wiring methods in Chapter 3. Flexible cord-and plug connection shall be permitted, provided that the cord does not exceed _____ in length.
 - A. 1 ft
 - B. 2 ft
 - C. 3 ft
 - D. 5 ft

5. 700.19 Multiwire Branch Circuits. The NEC now states that the branch circuit serving emergency lighting and power circuits shall be part of a multiwire branch circuit.
 - A. TRUE
 - B. FALSE

6. 700.24 Directly Controlled Luminaires. The NEC now requires that luminaires and external bypass controls shall be individually listed for use in emergency systems, where emergency illumination is provided by one or more directly controlled luminaires that respond to an external control input to bypass normal control upon loss of normal power.

- A. TRUE
- B. FALSE

7. 700.27. The 2014 NEC now requires the use of a licensed professional engineer or other qualified persons to design and select the selective coordination of the overcurrent protective devices for emergency systems.
- A. Journeyman
 - B. Licensed professional engineer
 - C. Qualified person
 - D. b and c
8. 702.7 Signs. The 2014 NEC now requires a warning sign shall be placed near the inlet to indicate the type of derived system that the system is capable of based on the wiring of the transfer equipment, where a power inlet is used for a temporary connection to a portable generator. The sign shall display which of the following warnings?
- A. WARNING: FOR CONNECTION OF A SEPARATELY DERIVED (BONDED NEUTRAL) SYSTEM ONLY
 - B. WARNING: FOR CONNECTION OF A NONSEPARATELY DERIVED (FLOATING NEUTRAL) SYSTEM ONLY
 - C. No warning sign is needed in this situation.
 - D. a or b
9. 702.12(B). Where a portable generator, rated 15 kW or less, is installed using a flanged inlet or other cord- and plug-type connection, a disconnecting means _____ where ungrounded conductors serve or pass through a building or structure.
- A. Shall not be required
 - B. Shall be required
 - C. Shall be optional
 - D. All of the above
10. 708.52 What is the new requirement for minimum separation between the service and feeder ground-fault tripping bands?
- A. Six-cycle
 - B. Two-cycle
 - C. Manufacturer's recommendation
 - D. None of the above.
11. 725.2 Power-Limited Tray Cable (PLTC) is a factory assembly of two or more insulated conductors rated at 300 volts, _____, under a nonmetallic jacket.
- A. With associated bare or insulated equipment grounding conductors
 - B. without associated bare or insulated equipment grounding conductors
 - C. a or b
 - D. Neither of the above
12. 725.3 The new 725.3(L) will assure that Class 2, and Class 3 circuits shall comply with the

applicable requirements in 110.11, 300.5(B), 300.6, 300.9, and 310.10(G) when installed in what types of conditions?

- A. Corrosive
- B. Temperatures above 100° F
- C. Wet
- D. Damp

13. 725.154 The new Table 725.154 entitled "Applications of Listed Class 2, Class 3 and PLTC Cables in Buildings" leaves open to interpretation whether an application is prohibited or overlooked.
- A. TRUE
 - B. FALSE
14. 725.179 Which two methods are acceptable to establish cable survivability for Class 2, Class 3, and Type PLTC cables?
- A. PVC tubing
 - B. Trenching
 - C. Circuit integrity (CI) cables
 - D. Electrical circuit protective systems
15. 728.5 Installation of fire-resistive cable systems outside the fire-rated rooms that they serve have different requirement details than other types of cables.
- A. TRUE
 - B. FALSE
16. 750.30(B). An energy management system shall not be permitted to cause disconnection of power to which of the following? Select all that apply.
- A. Elevators, escalators, moving walks, or stairway lift chairs
 - B. Circuits supplying emergency lighting
 - C. Ventilation used to exhaust hazardous gas or reclassify an area
 - D. Essential electrical systems in health care facilities
17. 760.24(B). Circuit integrity (CI) cables shall be supported at a distance not exceeding _____.
- A. 12 in.
 - B. 18 in.
 - C. 20 in.
 - D. 24 in.
18. 770.110 (C). The new provisions added at 770.110(C) for "Cable Routing Assemblies" makes it clear that optical fiber cables are permitted to be installed in which type of routing assemblies?
- A. Plenum cable routing assemblies
 - B. Riser cable routing assemblies
 - C. General purpose routing assemblies
 - D. All of the above

19. 770.154. Devices used for grounding and bonding application are no longer required to be listed for that purpose.
- A. TRUE
 - B. FALSE
20. 770.180. Where bonding or grounding is required, devices used to connect a shield, sheath, or non-current-carrying metallic members of a cable to a bonding conductor or grounding electrode conductor _____.
- A. Shall be listed
 - B. Shall be part of listed equipment
 - C. a and b
 - D. a or b
21. 770.154(a) What was the purpose of adding the information not to table 770.154(a)?
- A. It was added to indicate that cable routing assemblies are not addressed in NFPA-90A-2012
 - B. It was added to indicate that cable routing assemblies are not addressed in NFPA-80A-2012
 - C. It was added to indicate that cable routing assemblies are not addressed in NFPA-70A-2012
 - D. It was added to indicate that cable routing assemblies are not addressed in NFPA-60A-2012
22. 770.110 (C) A change at 770.110 was the addition of Subsection (C) to include provisions for _____.
- A. Conduits
 - B. Optical Fiber Cables
 - C. Cable Routing Assemblies
 - D. CATV raceways
23. 760.24 Fire alarm cables must be supported by: (Mark all that apply)
- A. Straps
 - B. Staples
 - C. Cable Ties
 - D. Hangers
24. 725.2 Which type of cables use both remote-control, signaling or power limited systems that supply critical circuits to ensure survivability for continued circuit operation for a specified time under fire conditions?
- A. Fiber optical cables
 - B. Circuit integrity (CI) cables
 - C. Coaxial cables
 - D. Twisted pair cables
25. 725.2 Power-limited tray cables (PLTC) are commonly used in power-limited circuits and for applications such as in the mass transit industry.
- A. True
 - B. False

Exam: 2014 NEC Changes - Chapter 8: Communications Systems (RV-10519)

1. The provisions of Chapter 8 Communications Systems are not subject to the general requirements contained in Chapters 1 through 4 or the special requirements of Chapters 5 through 7, except where:
 - A. A Chapter 8 rule specifically refers to one of those chapters
 - B. Installations of communications equipment under the exclusive control of communications utilities located outdoors, or in building spaces used exclusively for such installations, are exempt from the NEC ARTICLE 700 Emergency Systems
 - C. Neither of the above
 - D. Both a and b

2. 800.2 defines Point of Entrance as the point within a building at which the communication wire or cable emerges from:
 - A. An external wall, from a concrete floor slab
 - B. From a rigid metal conduit (Type RMC)
 - C. An intermediate metal conduit (Type IMC) connected by a bonding conductor or grounding electrode in accordance with 800.100(B)
 - D. Any of the above

3. 800.2 Definitions. Innerduct is a nonmetallic raceway placed within a larger raceway.
 - A. Metallic
 - B. External
 - C. Nonmetallic
 - D. Any of the above

4. 800.179. Under carpet communications wire and cable shall have a cable marking of:
 - A. CMP
 - B. CMUC
 - C. CMR
 - D. CMX

5. 800.179 (G) (1). Circuit integrity (CI) cables specified in 800.179(A) through (E), and used for survivability of critical circuits, shall have an additional classification using the suffix "CI." In order to maintain its listed fire rating, circuit integrity (CI) cable shall only be installed in free air.
 - A. TRUE
 - B. FALSE

6. 800.179 (G) (1). Informational Note: One method of defining circuit integrity (CI) cable is by establishing a minimum _____ fire resistance rating for the cable when tested in accordance with ANSI/UL 2196-2006, Standard for Tests of Fire-Resistive Cable.

- A. 1-hour
- B. 1 ½ hour
- C. 2-hour
- D. 3 hour

7. 800.179 (G) (2). Electrical circuit protective systems shall have a cable marking of:
- A. FHIT
 - B. CI
 - C. CMP
 - D. CM
8. 800.182 (A). Plenum communications raceways and plenum cable routing assemblies shall be listed as having _____.. Which of the choices below is incorrect?
- A. Adequate fire-resistant
 - B. Low-smoke producing characteristics
 - C. Maximum flame spread distance of 3 ft or less
 - D. All of the above
9. The 2014 NEC added “non–power-limited fire alarm circuit conductors” to the type of conductors which underground coaxial cables are required to be sectioned off from when installed in a:
- A. Duct
 - B. Pedestal
 - C. Handhole enclosure, or manhole
 - D. Any of the above
10. 830.24. Cables installed exposed on the surface of ceilings and sidewalls shall be supported by the building structure in such a manner that the cable will not be damaged by normal building use. Such cables shall be secured by hardware including _____, or similar fittings designed and installed so as not to damage the cable.
- A. Straps
 - B. Staples
 - C. Cable ties
 - D. Any of the above